

02/2022

VVA VERLAG  
Cologne / Germany

# EXTRUSION INTERNATIONAL

USA

# Guill

WORLD LEADER IN EXTRUSION TOOLING

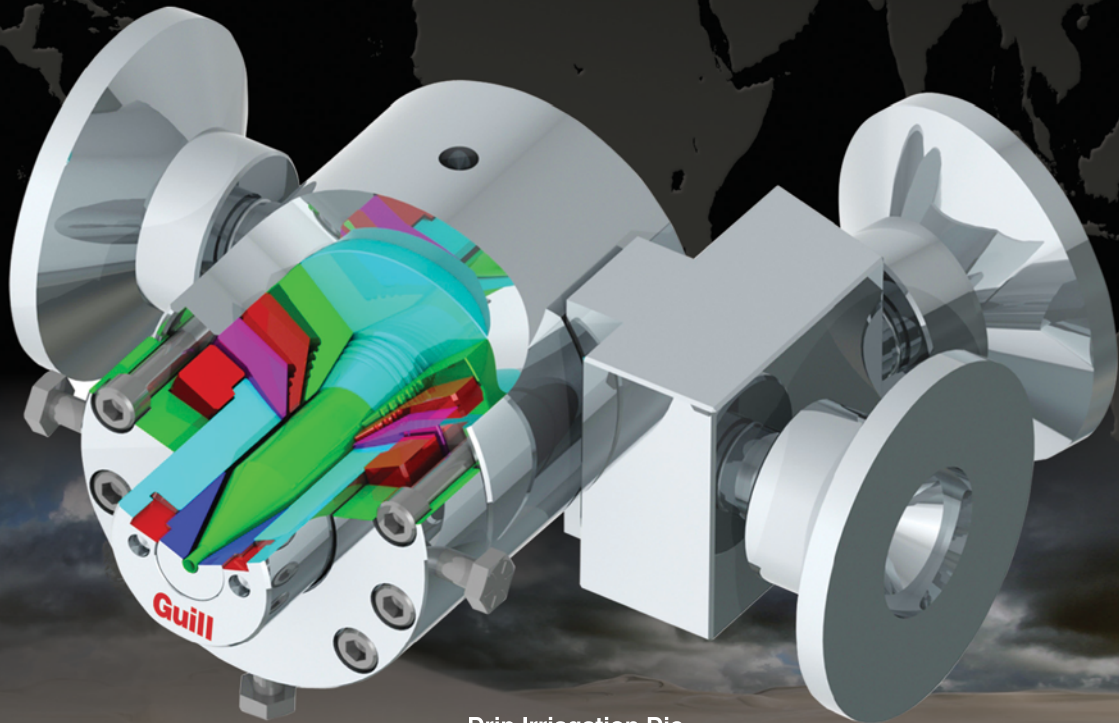

Drip Irrigation Die

[www.guill.com](http://www.guill.com)

## Profile guillotine PTT-200

INNOVATION



- Especially for complex as well massive profiles.
- Basic construction consists a frame in solid Aluminum construction in which the controls are integrated.
- Through large sliding windows fast and comfortable access to the cutting unit.

### Particularities:

- For this special version of the cutting knife head the cutting knife can be set in any position. This allows the slope of the knife to the respective profile geometry optimally adapted become.
- A new clamping system, which fix the knife at 4 points. It allows more pulling force on the blade to cut more massive profiles.
- The new clamping system result in a much higher angular accuracy of the cut.



## PCL Profile separating machine



When profiles are extruded, start-up profiles occur again and again. They are representing a high material value. It is very labour intensive to recycle this profiles.

With the PCL profile separating machine from Stein Maschinenbau, this process is greatly facilitated and accelerated many times over.

Thanks to its quickly exchangeable cutting units, as well as the two powerful caterpillars, the PCL can cope with any profile and allows you to recycle your profiles in the best possible way. By non-cutting separators, the profile is split into individual Material fractions which are optimally recyclable. Smaller sections are sorted and granulated directly in the machine.

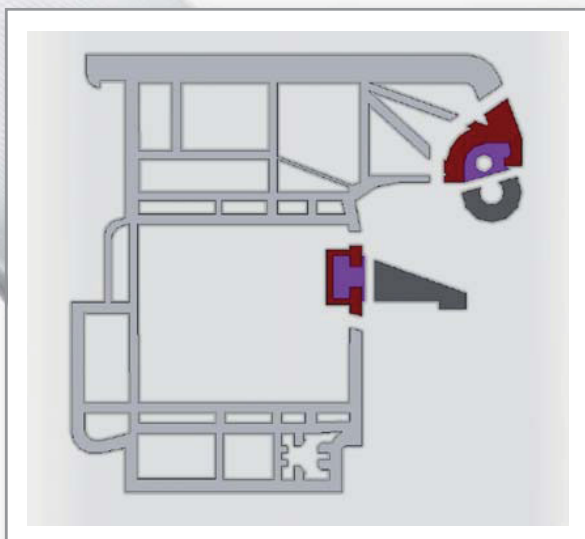

**The PCL from Stein Maschinenbau separates YOUR profiles!**

### Your advantages

- + High throughput
- + Short changeover times
- + Highest possible Recycling degree
- + Unmixed material separation



**STEIN Maschinenbau  
GmbH & Co.KG**

Wartbachstr. 9  
D-66999 Hinterweidenthal/Germany  
Tel. +49/63 96/92 15-0  
Fax +49/63 96/92 15-25  
stein@stein-maschinenbau.de  
www.stein-maschinenbau.de

Firms in this issue	6	RPET/PET Capacity to Beaver	
Imprint	7	Site Added to Further Grow Sustainable	
<b>Industry News</b>	8	Healthcare and Food Packaging Market	
Calendar	8	in North America	28
K 2022 – Global Plastics and Rubber Industries		Sustainably Produced Compounds	29
get their Act Together for Climate Protection,		Personalia	30
the Circular Economy and Digitalisation	8	TCO Certification Received	30
„Packaging Speaks Green 2022“	9	US-Based Sulfone Polymers Business Expanded	30
Interplastica 2022 and upakovka 2022 Exceed	9	Automated Six-Axis Case Packer for Lid and	
Expectations	9	Container Packaging Introduced	31
New Business Unit Project Acquisition	10	Expansion	31
CHINAPLAS 2022 Postponed	10	2022 Sustainability	
START-UP ZONE – New at K 2022	10	Innovation Award Winners	32
New Conference on Plastic Films in Mobility	11	Broad Range of Sustainable Thermoplastic	
Business Activity in South East Asia Expanded	12	Elastomers (TPEs)	33
Changes in Responsibilities on the Board of		<b>Extrusion Tooling</b>	
Executive Directors	12	Getting the Most from Your Extrusion Tooling	34
Interplas 2023	13	<b>Profile Extrusion – Case Study</b>	
More Transparency in European Data on Recycled		Polish Profile Manufacturer Expands	
Plastics	14	with Space-Saving Extrusion Solution	38
Virtual Service Expanded	14	<b>Blown Films</b>	
Rebranding of CabideX Protective Coatings for		Record Output Rates for Heavy-Duty Bag	
Feedscrews Announced	15	Applications	39
Reducing Production Downtimes	16	<b>Extrusion Technology</b>	
Next Generation Twin-screw and Single-Screw		High Productivity	
Extrusion Lines for PVC and PO Pipes Launched	16	in Medical Tube Extrusion	40
Distribution of Bioplastics	18	<b>Extrusion Coating – Case Study</b>	
Reciprocating Head Introduced	18	Resin Development Taken	
Melt Filter for PET Recycling System Delivered	19	to the Next Level with Installation of Extrusion	
Market Study: Stabilizers	20	Coating and Laminating Line for Flexible and	
RegXcellence for Plastic Additives Launched	20	Aseptic Packaging Applications	41
Capital Equipment Sales Manager Appointed	20	<b>Circular Economy, Recycling</b>	
Sheet Manufacturer Future Proofs		In-House Extruder Test Line Added	42
its Extrusion Line by Retrofitting	21	<b>Quality Control – Case Study</b>	
Universal PCR TPE – A Multitalented		Efficient Quality Control	
Compound for the Plastics Industry	22	at the End of the CV Line	43
Innovative Bonding Technology to Join		<b>Recycling – Case Study</b>	
Different Resin Materials Introduced	22	Working Together Over Generations	44
Optimistic Business Conditions in the European		<b>Recycling – Case Study</b>	
Plastics Industry	23	MENA PET Recycling Giant Signs	
New Packaging Valley Member	24	Contract for New Recycling System	46
New LongFiber-Reinforced Thermoplastic is Made		<b>Recycling – Case Study</b>	
of Regenerated Cellulose for Lighter Weight and		Super Recycling in Romania	48
Higher Strength	24	<b>Recycling</b>	
First-Ever Female Duo Leads		Hygienic Shields Become High-Quality Recycling	
PLASTICS Marketing Efforts for NPE2024	25	Resources	50
New Line in Italy for Specialty,		<b>Processing</b>	
Technical Rubber Customers	25	Pump & Filtration Systems,	
New 800 Series Hybrid Extrusion		Pelletizing & Pulverizing Systems,	
Tooling Announced	26	Recycling Systems and Digital Solutions	
New High-Output Pulverizer Expands		at Greenplast 2022	51
Capacity for PVC Extruder	26	<b>Recycling – Case Study</b>	
PLASTPOL 2022	27	Sustainable Composite Decking	52
New Research Report	27	<b>Plastic Pipes</b>	
Cooperation	27	CO2 Reduction and Cost Savings Through	
<b>Industry News USA</b>	28	Physically Foamed Cable Protection Tubes	55
Nonwovens and Converting Solutions at Techtexil		<b>Extruder Technology</b>	
North America	28	Focus on the Medical Market Expanded	56



**39** Reifenhäuser Blown Film presents a new high-performance cooling system on the market for its "EVO FFS" blown film line. It was specially developed for heavy-duty bag applications and achieves record output rates of more than 600 kg/h



For decades, plastic and paper waste has been sent overseas to be recycled. Repurposing plastic waste where it's created can provide a new income stream for businesses while eliminating the need to ship waste materials across the ocean. Fiberon has embraced this process, proving that being attentive to the environment does not always have to be a financial burden

**52**

A great number of hygienic shields is being used in industrial and trade facilities, as well as in the catering trade and restaurant business. Now the disposal of these highly transparent plates becoming an issue. Krall Kunststoff-Recycling has foresightedly prepared for a sustainable recycling

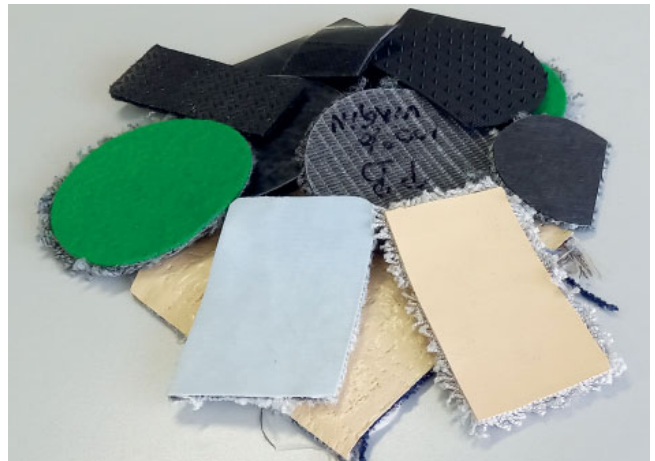
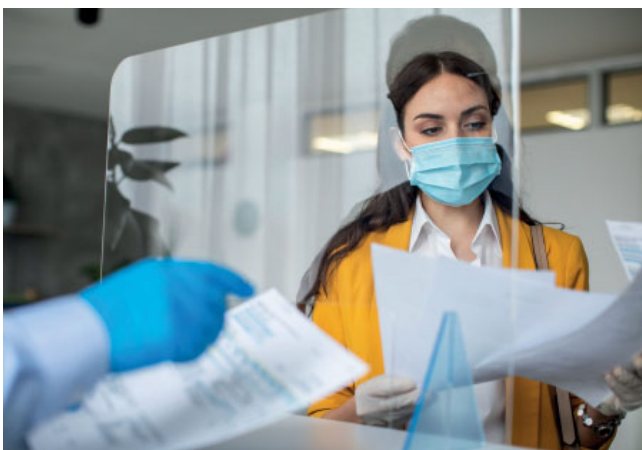

The Benelux carpet and artificial turf industry has taken a big step toward a greener future with the recent release of an industry road map. In the document the industry sets out ways to significantly reduce energy usage. Meaf Machines has now set up its in-house extruder test and demonstration line specifically to help manufacturers to try out new greener carpet backing materials

**42**



Based in Giza, Egypt, the biggest PET bottle-to-bottle recycler in MENA region is expanding and upgrading its existing plant with another Starlinger PET recycling system and an additional solid-state-polycondensation (SSP) reactor

**46**

The two coextrusion solutions supplied by battenfeld-cincinnati in 2019 proved so perfectly satisfactory to the modern Polish system manufacturer of door and window profiles from the very beginning that they immediately placed repeat orders for several more

**38**



## Index of Advertisers, companies and *fairs* referred in this issue

<b>Adsale</b>	10	<b>Maag</b>	51
A Più	9	Meaf	42
<b>BB Engineering</b>	17, 19	<b>motan-colortronic</b>	7
BariQ	46	Muller Technology	31
BASF Plastic Additives	20	<b>Nanjing Lesun</b>	19
BASF SE	12	<i>NPE2024</i>	25
battenfeld-cincinnati	38	Orion	25
Bausano	16, 40	Pallmann	26
Beier	21	PIE	23
BIO-FED	18	PLASTICS	32
Busch	16	Plastpol 2022	27
Ceresana	20	Polyrec	14
<i>Chinaplas</i>	10	Polyplastics	22, 24
Collin	12	PROMIX	54
CV. Wahana Mitra	12	Reifenhäuser Blown Film	39
Davis-Standard	20, 28, 30, 41	RVVP	12
Decco	38	Ser North America	29
EREMA	44	SI Group	31
Erge	15	Sikora	43
Extreme Coatings	15	Sirmax	29
FRX Polymers	30	SKZ	11
GINDUMAC	10	Smart-Extrusion	33, 36, 49, Inside Back Cover
Gneuss	21	SML	11
<b>Guill</b>	Outside Cover, 18, 26, 34	Solvay	30
Huhtamaki	27	Starlinger	46
ILLIG	14, 24	Stein Maschinenbau	Inside Front Cover+3
<i>Interplas 2023</i>	13	Targi Kielce	27
<i>interplastica 2022</i>	9	TOMRA	46
<i>IPTF 2022</i>	45	United Soft Plastics	33
<b>K 2022</b>	8, 10	US Extruders	50
Klößner Pentaplast	28	VM Verlag	Outside Back Cover
Kraiburg TPE	22	<b>WEIMA</b>	48, 52
Krall Kunststoff-Recycling	50	<b>Zumbach</b>	13



## Follow the news in the world of extrusion!

Subscribe to digital magazines  
and Smart Extrusion weekly newsletter

- **Just** submit your **e-mail address**.
- Digital magazines and news updates **free of charge**
- No spam. Your data is safe



[www.extrusion-info.com/subscription](http://www.extrusion-info.com/subscription)



The Extrusion International Magazine is published bimonthly by VM Verlag GmbH. P.O.Box 501812, D- 50879 Cologne, Germany

**EDITORS**

Bettina Jopp-Witt (Editor-in-chief)  
Tel. +49 221 546 1539  
redaktion@vm-verlag.com

Dmitry Kosuch  
Tel. +7 996 730 0113  
d.kosuch@vm-verlag.com

**ADVERTISING SALES**

Martina Lerner  
Tel.+49 6226 971515  
lerner-media@t-online.de

Bella Eidlin  
Tel. +49 152 29907895  
b.eidlin@vm-verlag.com

Olga Kirchner  
Tel. +49 152 05626122  
o.kirchner@vm-verlag.com

**ADMINISTRATION**

Alla Kravets  
Tel. +49 2233 949 8793  
a.kravets@vm-verlag.com

**PRINTING**

maincontor GmbH  
Dr.-Gammert-Str. 13a, 63906 Erlenbach, Germany  
T.: +49 937294810811  
www.maincontor.de, info@frankhohmann.com

**SALES REPRESENTATIVES**

Quaini Pubblicita (Milano IT)  
Tel. +39 02 39216180  
info@quaini-pubblicita.it

China & Asia  
octavia@ringier.com.hk, Tel. +852-9648-2561  
maggielu@ringiertrade.com, Tel. +86-13602785446

Tokyo PR Inc. (Japan)  
Tel. +81 (3) 3273-2731  
extrusion@tokyopr.co.jp

**Reprints, Translation etc**

No part of this publication may be reproduced, stored in a retrieval system, or transmitted, in any form or by any means, electronic, mechanical, photographic, recording or otherwise, without prior permission of the publisher.



[www.smart-extrusion.com](http://www.smart-extrusion.com)

# Perfect and constant dosing

 think materials management



## SPECTROPLUS

A dosing unit for all extrusion- and compounding tasks.

motan-colortronic gmbh - [info@motan-colortronic.de](mailto:info@motan-colortronic.de)  
[www.motan-colortronic.com](http://www.motan-colortronic.com)



#### Plastasia 2022

20. – 23. April 2022  
New Delhi, India

#### IPTF 2022

17. – 18. 05. 2022  
Saint Petersburg, Russia  
[www.iptf.extrusion-info.com](http://www.iptf.extrusion-info.com)

#### Measurement World 2022

17. - 20. 05. 2022  
Paris / France  
[www.global-industrie.com](http://www.global-industrie.com)

#### COLOMBIAPLAST

26. - 30. 09. 2022  
Bogotá, Colombia  
[www.eng.colombiaplast.org](http://www.eng.colombiaplast.org)

#### wire South America

**TUBOTECH**  
25. – 27. 10. 2022  
[www.wire-south-america.com](http://www.wire-south-america.com)  
[www.tubotech-online.com](http://www.tubotech-online.com)

#### INDIA ESSEN WELDING & CUTTING 2021

23. - 25. 11. 2022  
Bombay, India  
[www.india-essen-welding-cutting.com](http://www.india-essen-welding-cutting.com)

#### Plast Eurasia

23. – 26. 11. 2022  
Istanbul, Turkey  
[www.plasteurasia.com](http://www.plasteurasia.com)

#### interpack 2023

04. - 10. 05. 2023  
Düsseldorf, Germany  
[www.interpack.de](http://www.interpack.de)

#### PLAST 2023

05. - 08. 09. 2023  
Milan, Italy  
[www.plastonline.org](http://www.plastonline.org)

#### SCHWEISSEN & SCHNEIDEN

11. - 15. 09. 2023  
Essen, Germany  
[www.schweissen-schneiden.com](http://www.schweissen-schneiden.com)

## K 2022 – Global Plastics and Rubber Industries get their Act Together for Climate Protection, the Circular Economy and Digitalisation

■ At the start of the K year it becomes evident once again that the plastics and rubber experts all agree: K in Düsseldorf is the most relevant meeting point for the entire industry worldwide. Exhibitors from throughout the world come to Düsseldorf to demonstrate the operational excellence of the industry and actively chart the course for the future together with visitors. And this course clearly leads to climate protection, circular economy and digitalisation – and these are also the three declared guiding themes of K 2022.

The open exchange and dialogue on solutions-oriented innovations and sustainable developments across national borders and continents will also be in focus at this year's K in Düsseldorf. It fulfils the ideal prerequisites for engaging in intense global networking and for jointly advancing projects. Because nowhere else is the plastics and rubber industry gathered in one place with such a high degree of internationality.

Suppliers from Europe, especially from Germany, Italy, Austria, Turkey, the Netherlands, Switzerland and France will be particularly well represented again this year, but also from the USA. At the same time, K clearly reflects the changes affecting the global market: the number and presentation areas of companies from Asia have remained at a constant high for several years now. We can expect impressive appearances, especially from China, Taiwan, India, South Korea and Japan.

The approximately 3,000 exhibitors from 61 countries will occupy Düsseldorf Exhibition Centre in its entirety.

K 2022 is already now providing pooled expert know-how with its K-Talk. Once a month this digital live talk in English features exciting panel discussions with a changing line-up of international participants dealing with different focal themes but always with a focus on the three guiding themes of K 2022.

Launched last April, the online magazine K-MAG targets all industries related to K and delivers facts, news, stories and trends from the international plastics and rubber industry in German and English all year round.

K-monthly is the name of the new Newsletter of K in Düsseldorf. Subscribers not only receive the most interesting news and stories from the K-MAG via e-mail on a monthly basis but also current information revolving around K in Düsseldorf and the international trade fairs of the K-Global Gate family of products.

Save the date: the Ticketshop for K 2022 opens in April 2022.





## „Packaging Speaks Green 2022“

■ From 3 to 5 May, the world of sustainable packaging will meet in Milan for Packaging Speaks Green, the international forum on sustainability in the packaging supply chain which will be back as an in-person event in the Fiera Milano exhibition centre in Rho.

The conference will be held in conjunction with IPACK-IMA, devoted to processing and packaging technologies and GreenPlast, which focuses on the plastics and rubber industry.

Panel discussions, debates and presentations of case histories by prominent opinion leaders, industry stakeholders and institutional speakers will be held during this edition of the forum, which will present new tools and methods for the design, use, recycling and reuse of sustainable packaging.

Packaging Speaks Green 2022 is organised by Pack Media, a leading publisher in the world of packaging, with the support of UCIMA (Italian Packaging Machinery Manufacturers' Association) and AMAPLAST (Italian Plastics and Rubber Processing Machinery and Moulds Manufacturers' Association).

The first edition of the forum hosted 35 international speakers, 450 participants from twenty countries and 40 accredited journalists. Following its success, the brand has been launched as a web magazine exploring the theme of green innovation. A shortened version called "Pocket" was presented at MEAT-TECH in 2021.

In 2022 Packaging Speaks Green will be back for an exciting new edition.

► A Più S.r.l.  
www.a-piu-srl.com

## interplastica 2022 and upakovka 2022 Exceed Expectations

■ After their four-day run as in-person events interplastica and upakovka – Processing & Packaging have achieved extremely successful results. For the first time since the beginning of the Covid-19 crisis, the trade fair duo took place live in Moscow. A total of 17,000 visitors came to the Central Exhibition Complex Expocentre from 25 to 28 to see the innovations of 650 exhibitors from 32 countries, to make or intensify contacts and to take part in the extensive lecture programme. The mood in the halls was good, and exhibitors praised in particular the high quality of the contacts.

"interplastica 2022 was a great trade fair. Germany, Italy, Austria and Switzerland were represented with official country pavilions, as was Russia with its key players," said a delighted Thomas R. Stenzel, Managing Director of Messe Düsseldorf Moscow. "Trade visitors at interplastica were finally able to exchange ideas with specialists in person again, discuss current issues in the industry and examine innovative solutions live," continues Stenzel.

Trade visitors from 63 countries, including Russia, Belarus, Kazakhstan, Uzbekistan, Armenia, Azerbaijan and Ukraine, unanimously praised the diversity of the exhibitors, their professionalism and the high level of trade fair preparation. During the four days of the fair, the atmosphere in the exhibition halls was exceptionally busy and positive.

Suppliers from the fields of machinery and equipment for the production and processing of plastics and rubbers, raw and auxiliary materials, products made of polymers and rubbers, as well as services for the plastics and rubber industry presented themselves in Moscow. Many leading companies in the industry were represented at interplastica 2022.

Kalojan Iliev, Managing Partner at Erema Russia, sums up: "Our expectations of the event due to the current Covid situation were exceeded. Our stand was very well attended, important decision-makers were on site."

The Italian industry association AMAPLAST also underlines the high professional competence of the visitors: "The quality of the contacts was excellent. The Italian companies are

very satisfied with their participation and will definitely take part in interplastica again next year," says Eleonora Iula, Exhibition Department Project Manager.

Thorsten Kühmann, Managing Director of the Plastics and Rubber Machinery Association in the VDMA, states from the perspective of the German industry: "Exports of German plastics and rubber machinery to Russia already fell sharply in 2019 compared to previous years. After a strong upward trend in 2020, however, a downward trend set in again in 2021. This means that the Russian market has currently dropped out of the top 10 most important sales countries, but this huge market will retain an important position in the future. Russian plastics processors value the long-standing relations with German mechanical engineering and the promise of quality "Made in Germany". In addition, the machine builders are very well positioned in the topics of recycling and circular economy - which are also gaining enormously in importance in Russia – and can score points with their technologies against non-European competition."

The fact that Russia is planning to fundamentally modernise its infrastructure in the field of waste management in the next few years also brought a great response to the exhibition segment Recycling Solutions, in which exhibitors presented themselves specifically with solutions relating to recycling. Equally in demand was the Additive Minded segment, which was dedicated to applied science and additive technologies.

A highlight of interplastica was once again the Polymer Plaza. With top-class lectures and discussions on raw material production, application and processing, it provided valuable added value for trade fair visitors. Here, too, the theme day on circular economy and recycling was particularly popular. The next interplastica in Moscow will take place from 24 to 27 January 2023, again parallel to upakovka.

► www.interplastica.de



## New Business Unit Project Acquisition

■ According to management consultancy Falkensteg, the German mechanical and plant engineering sector was the industry most affected by insolvencies in the 2021 year-on-year comparison.

However, government support measures continue to keep the overall number of cases low. Nevertheless, the challenges posed by supply bottlenecks, rising raw material and energy prices and industrial structural change remain constant. The pressure on sales with rising credit costs is thus becoming increasingly greater for many machinery and plant manufacturers. A development from which renowned credit insurers predict an increase in global insolvencies for 2022.

The signs of this trend are also visible in the transactional machinery platform GINDUMAC. "We are very close to the pulse of industrial manufacturing. In recent months, more and more companies have asked us about restructuring their production in order to be able to achieve liquidity in the short term through machine sales. The number of offers for plant closures has increased significantly in the same period," explains Janek Andre, CEO GINDUMAC.

The increasing demand for project services in the context of plant closures has prompted GINDUMAC to create a new business unit, Project Acquisition. Oliver Maxeiner, an expert in industrial liquidation, has been recruited for the development of this new division. Maxeiner has many years of experience in project acquisition and project marketing of industrial assets.



From left to right: Janek Andre (CEO – GINDUMAC), Oliver Maxeiner (Account Manager Project Acquisition), Benedikt Ruf (Managing Director – GINDUMAC)

"With the new business division, we are following the signs of the market. With Oliver Maxeiner, we have been able to gain an experienced industry expert and entrepreneurial spirit who knows what is important in the project business in the manufacturing industry. We are pleased to be able to expand the area of project acquisition in an even more targeted manner with him and to be able to offer our industrial customers an even more comprehensive range of services," adds Benedikt Ruf, Managing Director GINDUMAC.

The focus for 2022 is on projects in Germany, Austria, and Switzerland. Further international projects will be considered according to business opportunities.

► GINDUMAC GmbH  
www.gindumac.com

## CHINAPLAS 2022 Postponed

■ In view of the latest COVID development and the further tightening of the pandemic control measures in Shanghai and other provinces of China, and to protect the health and safety of all show participants as well as to ensure the best participation result for the exhibitors, the organizer Adsale

informed that the 35th CHINAPLAS, International Exhibition on Plastics and Rubber Industries, scheduled to be held from 25-28 April 2022 at National Exhibition and Convention Center in Shanghai will be postponed. New dates and other details of the exhibition will be announced soon.

► Adsale Exhibition Services Ltd.  
www.chinaplasonline.com

## START-UP ZONE – New at K 2022

■ Start-ups are young, creative, flexible and particularly stand out with their innovative solutions. So what better fit

for K 2022 than to offer a dedicated presentation area to newcomers specialised in the development of innovative products and solutions revolving around plastics and rubber. And this is precisely what K 2022 will be doing with their START-UP ZONE to be found in Hall 8b of Düsseldorf Exhibition Centre at K from 19 to 26 October 2022.

At present, young companies can still apply for participation in the START-UP ZONE.

Basic requirements for participation in the START-UP ZONE include:

- Company no more than 10 years old
- Headcount below 100
- Annual turnover below EUR 10m

► www.k-online.de/start-up-zone-en



## New Conference on Plastic Films in Mobility

May 10th and 11th 2022,  
Wuerzburg/Veitshoechheim, Germany

■ Under the title of „Folien und Fahrzeug / Plastic Films in Mobility“, the symposium, which has been established for 15 years and is now being organized by the Kunststoff-Zentrum SKZ, is dedicated to design and technology trends in the interior and exterior, smart electronics integration and innovative decoration technologies, also against the background of sustainability requirements.

The structural changes with the digitization trend and the changes to electromobility give new impetus to the possible uses of film. Vehicle design and technology are key factors in the purchasing decision. Technologies of film decoration of surfaces enable design differentiations between vehicle manufacturers and also within vehicle categories. Functional integration through film technology, the integration of optical and haptic effects give variant options within closed surface structures.

The conference will be opened with a lecture by the proven China expert, political scientist and journalist Frank Sieren with a critical assessment of China's innovative power in the socio-political situation. What is now seen as state-of-the-art in the interior is increasingly being used on the exterior with new approaches in the area of front modules. The classic radiator grille of today's combustion vehicles will not only provide the face of the new EV vehicle and thus design options for film technology, it also conceals the sensors required for autonomous vehicles, which, in turn, also define the material properties of the plastics and plastic films. Safe operation even at low temperatures requires the integration of heating foils.



The symposium highlights all aspects of film technology along the entire process chain, from film production with the various polymer materials, the associated printing and film forming technologies, film back-injection technologies or integration processes. Sustainability with the intended circular economy sets additional requirements that require new thinking and innovative solutions. Functional integration stands in the way of sustainability and requires new solutions. With exciting topics, presented by competent speakers and an accompanying trade exhibition, the arc will be drawn at the May in Würzburg from the state of the art and practical experience to trends in industry in the various areas and regions to innovations from companies and research institutions.

The event will take place in compliance with the current Corona rules.

FSKZ e.V.

[www.skz.de/bildung/tagung/plastic-films-in-mobility](http://www.skz.de/bildung/tagung/plastic-films-in-mobility)

## ▶ each detail matters for unrivalled performance

Only a company who has a constant focus on the productivity of its customers thinks ahead and creates extrusion solutions that leave the rest standing. SML specialises in the development of extrusion lines for film, sheet, coating and lamination as well as multifilament spinning lines.

Extrusion lines.  
Engineered to perform.

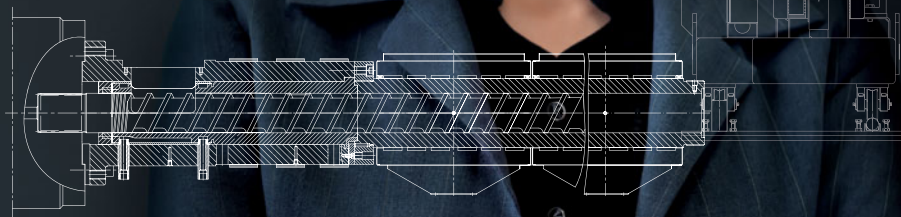

**SML**  
EXTRUSION LINES – ENGINEERED TO PERFORM ▶

[www.sml.at](http://www.sml.at)

## Business Activity in South East Asia Expanded

■ COLLIN Lab & Pilot Solutions is pleased about two new representatives in South East Asia. „With our new business partners, we can intensify our presence on this market, because both, RVVP International Corp. and CV. Wahana Mitra Abadi stand for years of expertise in the sector, have wide-ranging know-how and excellently trained service teams “, gladly explains Corné Verstraten, CSO / Joint Partner COLLIN Lab & Pilot Solutions GmbH.

RVVP INTERNATIONAL CORP. is a well-established trading company in the Philippines with focus on system engineering. The company provides different market segments such as the plastic processing industry, petrochemical industry and food industry with machines up to complete lines and provides process integration. The well trained and specialized service team forms the important basis for this company. As of now, RVVP International offers the complete COLLIN range of lines and machines.

CV. Wahana Mitra Abadi, a company which has successfully been working on the Indonesian market for decades, also supplies and supports the plastic processing industry, coating, chemical as well as food industry with lines and machines for the processing of polymers. As of now, the team offers the complete COLLIN extrusion lines portfolio.

NGA Plastic Technology Asia – Constant expansion and strengthening of the network in South East Asia: „At their



CV. Wahana Mitra Abadi in the Philippines

sites, both companies have been possessing more than 20 years of experience in the field of plastic processing and offer best support for our customers on site “, says Verstraten.

„With these local sales partners, we are even closer to our customers in South East Asia. Additionally, Hans Kammerer, Service Engineer at COLLIN Lab & Pilot Solutions, will move to Singapore in the first quarter of 2022, in order to support our local Sales Manager Jeffrey Tan, “explains Dr. Friedrich Kastner, CEO / Managing Partner COLLIN Lab & Pilot Solutions GmbH.

„With all these measures, we are again strengthening our worldwide sales and service network – corresponding to one of our strategical paths of NGA in Asia “, explains Corné Verstraten, who is also Managing Director of NGA Plastic Technology Asia PTE. LTD, which was founded in the middle of 2021.

*New COLLIN representatives: RVVP International Corporation in Indonesia (Pictures: ©COLLIN Lab & Pilot Solutions GmbH)*



■ COLLIN Lab & Pilot Solutions GmbH  
[www.collin-solutions.com](http://www.collin-solutions.com)

RVVP INTERNATIONAL CORP.  
[www.rvvp-international.com](http://www.rvvp-international.com)

CV. Wahana Mitra Abadi  
[www.wahana-mitra.co.id](http://www.wahana-mitra.co.id)

## Changes in Responsibilities on the Board of Executive Directors

■ The BASF Board of Executive Directors has decided on changes to the responsibilities in two Board Ressorts. These took effect on March 1, 2022, and are structured as follows:

Saori Dubourg (Ressort IV) assumes responsibility for the Monomers, Performance Materials, Petrochemicals and Intermediates divisions. She continues to be responsible for the region Europe.

Michael Heinz (Ressort V), based in Florham Park, New Jersey, assumes responsibility for the Agricultural Solutions, Care Chemicals and Nutrition & Health divisions. He continues to be responsible for the regions North America and South America.

■ BASF SE  
[www.basf.com](http://www.basf.com)

## Interplas 2023

■ Interplas, The UK's Definitive Plastics Event, is 75 Years Old in 2023. After a hugely successful 2021 show, Interplas will return to the NEC in September 2023 for a 3 day event.

Celebrating 75 years of Interplas, the 2023 edition will see almost 400 exhibitors present solutions, products, machines and ideas from across the plastics sector, as well as materials, automation, contract manufacturing and supporting technologies including software, testing, inspection, surface treatments and much more.

From the 26-28th September 2023, high-profile exhibitors will meet with over 12,000 attendees at the NEC, Birmingham to demonstrate the machinery, materials and services available to solve the current and future challenges of the plastics industry.

Duncan Wood, CEO of Rapid News Group said: "On the back of a highly successful 2021, despite the challenges of a pandemic and a fuel strike, we are looking forward to celebrating the 75th birthday of Interplas with the whole of the UK plastics industry."

The latest figures show the UK plastics market has a turnover of £27bn, with over 6,000 companies and 182,000 people directly employed by the industry; Interplas is the showcase for these numbers, and they come alive on the show floor.

After the incredible success of Interplas 2021, Interplas 2023 has seen a record rebook rate already, with many previous exhibitors eager to return and emulate the triumphs of previous years.

► Interplas Events Ltd  
<https://interplasuk.com/>

## Precision Wall Thickness Measurement

**Zumbach**  
SWISS PRIME MEASURING SINCE 1957

### RAYEX S

- Easy and quick set up for new products
- Fast eccentricity and diameter measurement
- Added longevity due to high-quality xray source



Family owned since 1957, Zumbach is a global leader in the industry. Driven by innovation and experience. We are here for you and ready to build the future together.

[www.zumbach.com](http://www.zumbach.com) • [sales@zumbach.ch](mailto:sales@zumbach.ch)

## More Transparency in European Data on Recycled Plastics

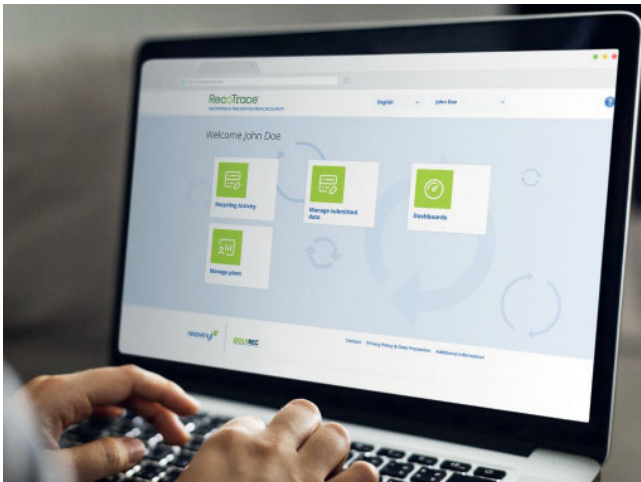

■ PolyREC®, the association that monitors, verifies and reports on European recycled plastics, is now recognised as an official data collector for the Circular Plastics Alliance (CPA). Thanks to RecoTrace™ data PolyREC® will report on the progress of the entire European plastics value chain towards the CPA target of 10 Mt recycled plastics use by 2025.

Ton Emans, President at Plastics Recyclers Europe, says on behalf of PolyREC®, "PolyREC® is calling on all plastic recyclers and converters to register their recycled plastic data into

RecoTrace™ and, in doing so, ensure transparency of the circular movement of European polymers. Understanding the size and dynamics of the European recycled plastics market will help inform future legislation and investment decisions that accelerate the transition to a circular economy."

Fully CPA compliant, RecoTrace™ is the first comprehensive data system to monitor both plastic recycling volumes and recycled plastic use for all main polymers.

The tool provides recyclers and converters with a free-to-use online platform to track progress against individual pledges to produce or use recycled content and helping to demonstrate commitment towards circularity.

Building on Recovinyl®'s 20+ years of data collection experience and expertise, RecoTrace™ inherits a proven track record and credibility in data monitoring. The system has now been expanded to include all main polymers: polyolefin (PO), polyethylene terephthalate (PET), polyvinyl chloride (PVC), polystyrene (PS) and expanded polystyrene (EPS), extruded polystyrene (XPS), polyamide (PA), acrylonitrile butadiene styrene (ABS) and polycarbonate (PC).

PolyREC® members have worked collaboratively to align all definitions and methodology used within RecoTrace™ to ensure comparability of data.

► [www.polyrec.eu/](http://www.polyrec.eu/)  
 ► <https://recotrace.com/auth/login>

## Virtual Service Expanded

■ ILLIG is expanding its customer service program with new virtual tools. Augmented reality (AR) devices and software solutions will be deployed to support customers remotely. The complementary visualization technologies will enable the use of technical maintenance, machine health checks, as well as the execution of a variety of tests in the ILLIG Technology Center (ITC) in real time. Pandemic-related lockdowns and restrictions on global travel have accelerated the acceptance of expanded remote technical customer support. The new virtual services are already successfully in use at ILLIG.

Factory acceptance tests (FAT) and subsequent machine commissioning at the customer's site are usually carried out with the physical presence of ILLIG technicians and customer staff. ILLIG has offered the possibility to carry out these demanding and complex procedures online for years. Until now, the direct exchange took place via portable devices such as smartphones, tablets, and high-end cameras in real time. Virtual services will extend and facilitate communication in the commissioning process and will speed up execution of related tasks.

With AR technology, ILLIG is expanding its digital service offering with the help of Microsoft HoloLens2. These mixed reality glasses allow the user to display interactive 3D projections in the immediate environment. Adapted to ILLIG's requirements, the glasses can be used, for example, for tests in the



ITC with direct transmission to the customer. The customer can actively participate in real time from his location using Microsoft TEAMS via smartphone, tablet or PC. Other applications with this technology include FATs, customer training, and live product presentations.

Additional options for accessible live communication for ad hoc support includes the use of the Inosoft i40 software portal at ILLIG. This web-based real-time support enables simple and fast direct contact with the customer via moving image and sound without the customer having to install any special software.

► ILLIG Maschinenbau GmbH & Co. KG  
 ► [www.illig.com](http://www.illig.com)

## Rebranding of CarbideX® Protective Coatings for Feedscrews Announced

■ Extreme Coatings, a leading global supplier of wear-resistant coating solutions for the plastics and rubber industries, has announced the rebranding of its CarbideX® series of high-performance coatings for feedscrew applications. As Pro-Line, these application-specific coatings are designed to optimize the performance of injection molding and extrusion machinery.

The new tradenames further educate the market on the company's robust offering, providing key product delivery enhancements and easier product selection for customers, according to Scott Caplan, Executive Vice President, Extreme Coatings. "The rebranding allows us to better reach the markets that can benefit from our premium coatings and more clearly articulate the potential applications for our OEMs, distributors, and end users," said Caplan.

The rebranded line includes WEARPRO (formerly C1000) for glass-filled, metal-filled, and other abrasive fillers for automotive and electronic applications, and MICROPRO (formerly C9000) formulations for calcium carbonate, silica, or other sub-micron particle filled resins for bottles, housewares, and sporting goods.

Newly developed is MEDPRO coatings which target medical grade polymers for plunger/syringe barrels, intravenous devices/stints, and implants. Meanwhile, COROPRO coatings (formerly C4000) formulations are for CVP, CPVC, and halogen-free polymers for pipe, electronic devices, TV screens, and flame-resistant components.

For extrusion applications, EXTRUPRO (formerly Fliteguard C1000) targets all applications while EXTRUPRO+ is for wood flour, calcium carbonate, talc materials for composite wood decking, or other filled resin extrusion applications.

Extreme Coatings' thermal spray technology applies wear and corrosion-resistant CarbideX protective coatings made of tungsten or chromium carbide to virtually any new or repaired feedscrew. The process provides a crack- and porosity-free coating within thicknesses ranging from .004-in to .017-in per side and hardness values over 60HRC. CarbideX Proline formulations deliver like-new performance and at least two to three times longer equipment life.



The company has also expanded its research and development activities. Plans call for a late 2022 launch of two new high-performance coatings to expand its Proline offering. The first is focused on super high-speed applications, targeting PET, LLDPE, and HDPE for buckets, caps, closures, and other packaging. The other new product launch will target polycarbonate applications for injection molded and extruded optical and automotive lenses.

► Extreme Coatings  
[www.extremecoatings.net](http://www.extremecoatings.net)

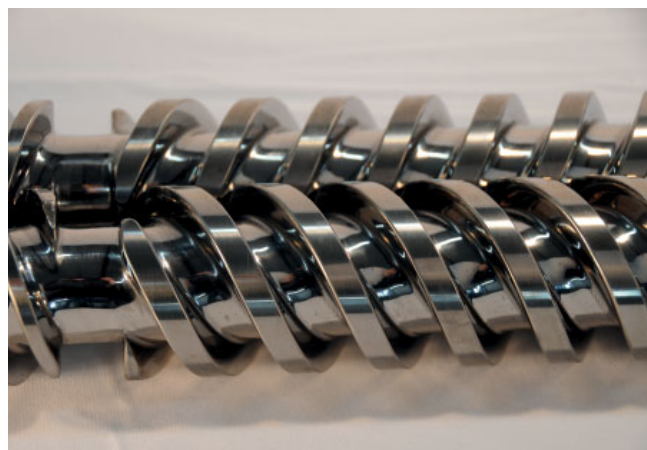

ERGE Elektrowärmetechnik - Franz Messer GmbH  
 91220 Schnaittach - Hersbrucker Straße 29-31  
 Tel. +49/9153/921-0 Fax +49/9153/921-117  
[www.erge-elektrowaermetechnik.de](http://www.erge-elektrowaermetechnik.de)  
 mail: [verkauf@erge-elektrowaermetechnik.de](mailto:verkauf@erge-elektrowaermetechnik.de)

HEIZEN  
HEATING

TROCKNEN  
DRYING

REGELN  
CONTROLLING

ELEKTROWÄRMETECHNIK FRANZ MESSER GMBH

## Reducing Production Downtimes

■ Production downtime is a big and expensive problem for factories and needs to be prevented. Intelligent IoT solutions can help to reduce production downtime and to save a lot of money. OTTO is the digital service innovation by Busch Vacuum Solutions. It combines condition monitoring of vacuum pumps with attractive service packages. For high process reliability and less cost of ownership in factories. The Busch IoT Dashboard and the Busch Vacuum App track vacuum pump data permanently. With the information at hand, the performance can be analyzed, and processes optimized. Busch installs a proprietary sensor package at the vacuum pumps, which collects and processes data. The data is stored in the Busch cloud via a mobile connection. The IoT box constantly monitors process state and vacuum pump conditions. For example, the ambient temperature, oil temperature and the remaining time until the next maintenance of the vacuum pump. The IoT dashboard provides all collected performance data 24/7. The data is interpreted, and performance trends are shown. To optimize the production, Busch is providing a summarizing report as well as recommendations for more efficient operation.

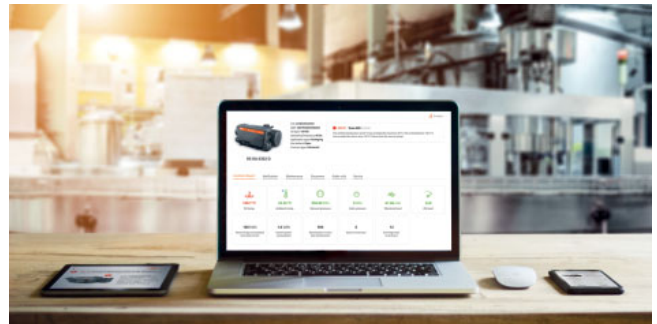

*The new OTTO digital services by Busch Vacuum Solutions reduce production downtimes*

Based on data analysis, Busch is taking care of preventive maintenance and sends a service technician if needed. OTTO digital services by Busch come in three different packages tailored to the needs of the customer.

Busch Dienste GmbH  
www.buschvacuum.com

## Next Generation Twin-Screw and Single-Screw Extrusion Lines for PVC and PO Pipes Launched

■ Bausano announced the launch of its next generation twin-screw and single-screw extrusion lines for pipes made of PVC and in polyolefins (PO). Bausano's extrusion technology in its twin-screw MD and single-screw E-GO ranges enables the production of different types of pipes – rigid or flexible, mono or multilayer, smooth or corrugated – for various applications, including construction, agriculture and medical.

“Expansion of our extrusion lines for PVC and PO pipes is the result of our unique ability to combine our technological expertise, process consultancy with customers and our passion for innovation,” says Clemente Bausano, vice president of Bausano. “Bausano has recently reinforced its Technical Department by adding a team of experts who have specific skills and consolidated know-how in designing these types of solutions. Our goal is to meet the needs of manufacturers as a reference partner by combining turnkey, highly customizable systems with top-notch services, thanks to dedicated technicians on site.”

Bausano's high-performance extrusion line for PVC pipes for diameters ranging between 63mm and 160mm features the MD Nextmover 170/30 model, which is equipped with a double exit die head, for overall production of 2,000 Kg/h. In detail, the gravimetric doser is designed to ensure maximum precision so the pipes in outfeed weigh the same. In addition, the 170/30 model features bimetallic screws and a cylinder that are subjected to less corrosion and wear.

Other innovative features include: cooling and calibration benches, made of stainless steel, for producing pipes with a flawless surface; two 9m parallel calibration benches in a two-chamber configuration with temperature and water level control, which allows different vacuum conditions to be created as required; and a high-performance pipe cooling system that cools pipes more quickly, thereby improving their quality and taking up less space when installing the line. Bausano also offers end-of-line accessories, including a drive system, cutting unit and belling machine.

Energy efficiency improvements in the MD and E-GO ranges are powered by two innovative systems: Bausano's Smart Energy System, with its electromagnetic induction principles that enables more rapid and uniform heating of the cylinder, for energy savings up to 35%; and its Digital Extruder Control 4.0, with a 21-inch screen, accurately monitors consumption of each single stage of the process and features a real-time display of performance for managing motor power, temperature, oil control unit inspection, screw adjustment and other parameters, on request.

Bausano's extrusion lines also meet the Smart Factory vertical integration requirements and are able to communicate with third-party systems, such as the sophisticated in-line measurement tool for accurate control of the internal and external diameter and wall thickness of the pipe.

Bausano  
www.bausano.com/en/



Clean. Nothing else.

The upgrade to your high-quality production line  
Polymer melt filtration by BB Engineering

High-quality polymer products start with highly-purified melt. As a retrofit to your plant our polymer filtration systems guarantee a perfect melt quality for many demanding applications.

- ✓ long service time
- ✓ high degree of fineness
- ✓ filtration area 0,4-40 m<sup>2</sup>
- ✓ different filter media

More info here: [www.bbeng.de](http://www.bbeng.de)

**BBENGINEERING**  
The Valueneering Company®

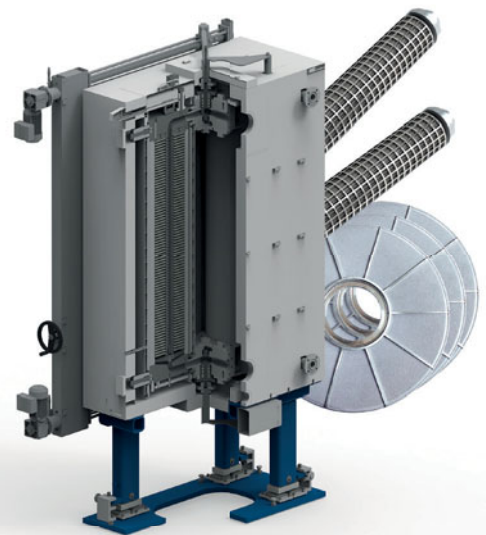

## Distribution of Bioplastics

■ The Cologne-based company BIO-FED and the Japanese Kyokuto Boeki Kaisha, Ltd. (KBK), Tokyo, signed a distribution agreement for the Japanese market at the beginning of 2022. BIO-FED, based in Cologne, is a branch of AKRO-PLASTIC GmbH and a member of the Feddersen Group. BIO-FED



*KBK's head office on the 7th floor of the Shin-Otemachi building in Tokyo (Copyright Kyokuto Boeki Kaisha, Ltd. (KBK))*

produces and distributes biodegradable and/or biobased plastic compounds under the brand name M•VERA® and had expanded its portfolio with ISCC PLUS and REDcert<sup>2</sup> sustainable certified M•VERA® compounds made from biomass-balanced polypropylene (PP).

"The bioplastics market in Japan has received a strong boost from the government's "Resource Circulation Strategy for Plastics" roadmap," says Dr. Stanislaw Haftka, Sales Director at BIO-FED. "With KBK, we have a competent and experienced partner at our side in this region who has a strong network in various industries in Japan," Haftka continues.

"By working with BIO-FED, KBK will be able to better meet the needs of the growing market every day, with an even stronger focus on sustainable products," says Tatsuya Okawa, General Manager, of Diversified & Innovative Materials Dept at KBK.

KBK will distribute the complete M•VERA® product range for blown film extrusion, injection moulding, extrusion and thermoforming applications in Japan, as well as the matching biodegradable or biobased masterbatches.

► **BIO-FED,**  
Branch of AKRO-PLASTIC GmbH  
[www.bio-fed.com](http://www.bio-fed.com)

## Reciprocating Head Introduced

### Automated Extrusion Process Drastically Changes the Extruded Profile

■ Guill Tool, a global manufacturer of extrusion tooling, has released its new reciprocating head. The traditional tip and die assembly is replaced with a linear reciprocating assembly that changes the tube's profile within a given length. This process is repeated throughout a single extrusion run without interruptions. Cutting capability, in association with the extrusion speed, cuts the finished product to length.

While cost and value stream activities are reduced, quality is improved. Only one extrusion run is needed to produce a finished product, as opposed to multiple extrusion runs



with tooling changes along with a manual assembly operation to connect different tubing shapes. Guill's new reciprocating head eliminates an assembly operation. It also eliminates in-process inventory. Thus, there is no need for storage of various tubing shapes and connectors needed for assembly, fulfillment of orders and replenishment of finished goods. Furthermore, the reciprocating head eliminates a connecting piece, allows JIT production and products made-to-order. Lastly, it reduces total run time from receiving the order to shipping. For more information:



► **Guill Tool & Engineering**  
[www.guill.com](http://www.guill.com)

## Melt Filter for PET Recycling System Delivered

■ 2021 saw BB Engineering (Germany) deliver a melt filter for recycling PET flakes to polyester manufacturer Indorama Polyester Industries (Thailand). Indorama will be using the type NSF38 filter in its recently assembled recycling system in order to produce rPET granulate from flake PET bottle waste. The NSF38 filter enables continual filtering – in other words, the system switches from one filter to the other during the process without the need for conversion shut-downs. The filter allows the processing of consumer waste – for example, in the form of shredded PET bottles – into new, high-quality rPET granulate. This granulate is subsequently processed into manmade fibers in spinning systems.

The NSF38 is a switchable filter with a filter surface area of ap-prox. 16 m<sup>2</sup> on each side, with throughputs of between 1,000 and 1,900 kg/h. The filter inserts each contain 19 pleated filter candles (60 x 1,000mm Ø). The filter medium comprises a sintered metal fiber nonwoven with a filtration fineness of 25 µm. This ensures that the melt remains free of contaminants and gel particles, which in turn enables the production of high-quality end products.



Graphical animation of NSF38

NSF38



# LESUN

## FOCUS

### SCREW | BARREL | SHAFT

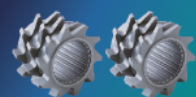
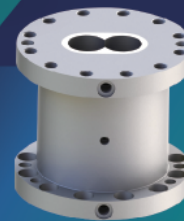
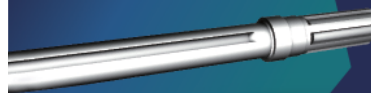

Nanjing Lesun Screw Co.,Ltd.

E:info@lesunscrew.com

www.lesunscrew.com

## Market Study: Stabilizers

■ Plastics have many enemies, but sunlight and oxygen are among the worst. Polymers must be protected against oxidation, UV rays, and heat with stabilizers. Without stabilizing chemicals, window frames, cables and many other plastic or rubber products could not survive for a long time, and often could not even be manufactured. Ceresana has now investigated the global market for these essential additives for the fifth time. Market researchers expect revenues from stabilizers for plastics and elastomers to grow to USD 6.7 billion annually by 2030.

Market Forecasts and Industry Analysis for Stabilizers: Chapter 1 provides a presentation and analysis of the global market for plastic stabilizers – including forecasts up to 2030: consumption as well as revenue are outlined for each region of the world. Furthermore, the global and regional demand is

analyzed for each product type and application area. Tin stabilizers, lead stabilizers, calcium-based stabilizers, liquid mixed metal stabilizers and other products are considered specifically.

Chapter 2 analyzes stabilizers demand and revenues for 16 countries. The demand is examined in detail for each stabilizer type and application areas.

Chapter 3 provides useful company profiles of the most important producers of stabilizers for plastics and elastomers. Detailed profiles are provided by the 70 most important manufacturers.

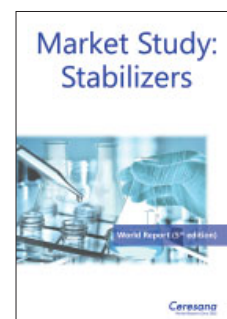

► Ceresana

[www.ceresana.com/en/market-studies/chemicals/stabilizers/](http://www.ceresana.com/en/market-studies/chemicals/stabilizers/)

## RegXcellence® for Plastic Additives Launched – A New Service for Regulatory Excellence

■ BASF launches a new service offering, RegXcellence®, for its plastic additives customers which enables targeted access to a range of global regulatory support. RegXcellence provides digital solutions and simplifies regulatory issue management with advisory support to accelerate innovation opportunities. The regulatory landscape changes constantly. It is increasingly challenging for global businesses to navigate the complex regulatory frameworks whilst remaining compliant.

“As a leading global producer of plastic additives, we leverage our extensive experience in the plastic industry and strong knowledge of product stewardship and chemical legislation to stay ahead of the evolving regulatory trends. We proactively support our customers to ensure responsible and appropriate use of our additive solutions,” says Dr. Thomas Kloster, President, Performance Chemicals, BASF. “With the extension of the successful RegXcellence service to include plastic additives, we now enable our customers to benefit from our extensive

regulatory service and expertise. Together, we can mitigate business risks, accelerate innovation, and achieve sustainable growth through regulatory compliance.”

As this service expands, plastic additives customers will have access to a convenient digital solution to access regulatory documents. A global community of regulatory experts also evaluates relevant environmental, health and safety data. These experts are available to support customers when it comes to registration services or process and substance consulting. In addition, specific regulatory trainings are offered.

BASF already offers RegXcellence services to the customers of its fuel and lubricant solutions, plasticizers, pharma solutions and human nutrition businesses.

► BASF Plastic Additives

[www.plasticadditives.basf.com](http://www.plasticadditives.basf.com)

## Capital Equipment Sales Manager Appointed

■ Davis-Standard announced that Matthew Urban has been hired as Capital Equipment Sales Manager for the TSL (Thermoforming Systems, LLC) product line. In this role, Urban will

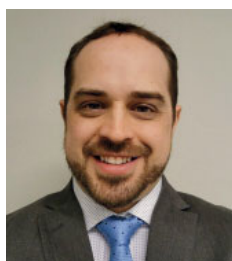

*Matthew Urban*

be responsible for global sales of TSL’s sheet and thermoforming technology primarily used for food and beverage end markets. TSL offers customers pellet-to-product solutions with a portfolio of formers, trim presses and rotary machinery, as well as in-line extrusion capabilities.

“Matthew understands thermoforming equipment and the customers we serve,” said Roger Moore, VP of Sales for TSL. “His leadership abilities and experience, knowledge of the industry, and commitment to service will be an asset to our market development efforts.”

► Davis-Standard, LLC

[www.davis-standard.com](http://www.davis-standard.com)

## Sheet Manufacturer Future Proofs its Extrusion Lines by Retrofitting

■ MP3, an Italian company belongs to I.L.P.A.- Holding. Their specialised factory in Valsamoggia factory manufactures high quality ABS, ABS/PMMA and PS sheet both for the furnitures and building industry and for thermoformed technical parts for vehicles, thermo sanitary etc.

In addition to the closed loop recycling of all internal PET scrap, MP3 now focuses on increasing the amount of recycled internal scrap from other thermoplastics, ABS or PS in their final products.

Five years ago, MP3 already replaced three of their existing screen changers with Gneuss SFXmagnus units on one of their sheet lines as previously they had been unable to use high percentages of recycled material without compromising the product quality. This sheet line consists of one main extruder and two co-extruders. PS, ABS and PMMA are processed on this line, with up to three colour changes daily. Thanks to the replacement of the screen changers with Gneuss systems, they were able to add up to 50 % regrind without either process disturbances or quality issues, even with a high contamination load.

The SFXmagnus Screen Changer is characterised by its large active filtration area for its overall external dimensions which means that it is especially well suited for retrofitting to existing lines. As with all the Gneuss Rotary Filtration Systems, the screenpacks can be changed during normal production, without pressure spikes or other disturbances. Consistent sheet surface quality can be ensured and this represents a competitive advantage for MP3.

In 2020, MP3 retrofitted another line with three SFXmagnus Rotary Filtration Systems and a further line was retrofitted with another three units early in 2022.



Sheet extrusion line at MP3 with three pressure- and process-constant Gneuss SFXmagnus melt filters







**BEIER Machinery**  
**Pipe Extrusion Line**

BE BEIER, BE GREENER

16-2500mm PE · 16-160mm PP PPR · 16-1000mm PVC  
110-630mm O-PVC · 80-800mm RTP

HIGH EFFICIENCY · LARGE DIAMETER · ENERGY SAVING  
EXTRUSION TECHNOLOGY

www.beierpm.com    www.beierextrusion.com

## Universal PCR TPE – A Multitalented Compound for the Plastics Industry

■ The latest solution from KRAIBURG TPE makes a post-consumer recycling proportion of 40% possible. The focus is also on quality and availability. That's what the plastics manufacturer is providing with its Universal PCR TPE – a compound with sophisticated mechanics that can be used universally. The world of plastics is currently experiencing a surge in sustainability values – faster, higher, greener is what the desired material is expected to be. But quality is an issue that must not fall by the wayside. The most sustainable solution is the one that can continue to be used for a long time. That saves time, energy and resources and scores points with consumers. Survey results prove this turnaround in preferences: Companies with a defective sustainability policy are punished, and people adjust their consumption patterns. Sustainability is a purchase criterion. KRAIBURG TPE is supporting customers with this shift in consumption behavior and, with Universal PCR TPE, is providing a multitalented compound that can be used in many different fields of application.

KRAIBURG TPE's latest thermoplastic elastomer (TPE) has been specially developed for consumer and industry applications and contains up to 40% post-consumer recycle (PCR). In accordance with ISO 14021, the manufacturer recycles materials that end consumers from households and industry can no longer use for their intended purpose. With its Universal PCR TPE, the competence leader is supporting customers and end users in implementing their sustainability targets and applications and is presenting a tough plastic that provides plenty of



The latest solution from KRAIBURG TPE makes a post-consumer recycling proportion of 40% possible (Image: © 2022 KRAIBURG TPE)

possible applications and is suitable as an alternative for established market solutions.

Universal PCR TPE also has strong points in color and mechanics. Designers and developers appreciate the various color and tone options designed to meet people's needs: Compounds are available in natural color as a basis for customer-specific color solutions as well as in a gray color characteristic for recycled plastics. Another feature worth emphasizing is the compound's processability, which is in no way inferior to that of standard solutions and sets new standards for PCR compounds. Product managers will benefit from constant and high quality as well as from availability in Europe. When needed, certificates of conformity with REACH and RoHS can be issued on request.

■ KRAIBURG TPE GmbH & Co. KG  
[www.kraiburg-tpe.com](http://www.kraiburg-tpe.com)

## Innovative Bonding Technology to Join Different Resin Materials Introduced

■ Polyplastics, a leading global supplier of engineering thermoplastics, has introduced an innovative bonding technology that is unlike traditional joining methods such as plastics welding or adhesion. AKI-Lock® has few restrictions on the materials that can be used and forms strong, airtight bonds with combinations of different materials for which bonding had previously been difficult.

AKI-Lock® opens the door to a broad range of new product development possibilities. The bonding technology meets the increased market demand for weight reduction to address Sustainable Development Goals (SDGs), reduces the number of parts, and provides stable adhesive strength and longevity.

The AKI-Lock® technology uses the glass fibers in glass fiber reinforced resins as a physical anchor for bonding. Glass fiber is made bare by laser irradiation which is completed in a grid pattern. Strong bonds can then be achieved by pouring the resin to be bonded onto these anchors. Since the bond is formed by physical anchors, there is no time limitation from

laser treatment until bonding. Masking is unnecessary since specific treatment areas can be identified. There is no need for etching solution to roughen the surface and no waste liquids or materials are produced.

Airtightness is greatly enhanced due to three factors: the effect of resin entering and filling the gaps between the glass fibers; deformation in the grooves of the primary material due to the shear flow force of the secondary material; and crimping from mold shrinkage of the secondary material. AKI-Lock® helps to reduce assembly work and the number of components, thus lowering overall cost. The joining system also helps to reduce environmental impact through the use of dry processes, including the elimination of adhesives.

\*AKI-Lock® is a registered trademark of Polyplastics Co., Ltd. in Japan and in other countries.

■ Polyplastics Co., Ltd.  
[www.polyplastics-global.com/en/](http://www.polyplastics-global.com/en/)

## Optimistic Business Conditions in the European Plastics Industry

■ To gauge how business is developing in the European plastics industry, PIE – Plastics Information Europe conducted its 7th Readers Survey in January 2022. The questionnaire was made open to PIE subscribers and other industry players, and saw more than 420 participants from across Europe.

Positive reports and optimistic expectations predominate the current situation in the European plastics industry. Three-quarters of the Pie survey respondents rate their business performance in the second half of 2021 being better than in the first half, or remaining stable, and about 90% of all market participants expect an upswing or at least stability in the upcoming months, combined with investments and staff increases.

The bad news: material, energy, shipping costs, and availability continue to weigh heavily on the outlook, even though the direct impacts of Covid-19 no longer seem to play a central role. Diversification among suppliers and alternative plastic material choices could be the solution, according to most of the respondents.

As for the hot topic of circular economy, pressure is mostly being turned into motivation, to change things around. And last but not the least, politics too has a major role to play here.

Across Europe, just under half of the respondents reported better business in H2 2021 than in the first half, with just under a quarter reporting a deterioration in business. However, the expectations for H2 2021 were more optimistic in 2021 summer: at the time, 88% of survey participants expected better or unchanged business – in January 2022, this is being echoed by just under 76% of the companies.

While more than half of the participants from German-speaking Europe, Italy, and the UK & Ireland stated an improved company performance in the second half of the year, the assessment in Central & Eastern Europe was worse: only a third described the business trend in H2 as better, compared to H1 2021. By sector, plastics recyclers did the best business by far, both domestically and for export, followed by raw material producers, and plastics machinery manufacturers. The foreign markets of the EU27+CH, NO, UK rated significantly worse in H2 than domestic and export together: here only a good third indicate a better performance. Business activities in the rest of

the world apparently fared even worse: whether it was pandemic-related or due to supply bottlenecks.

Nearly 89% of companies said they plan to invest at least as much or more in 2022 than they did in 2021. The only areas where fewer than 50% of the firms said they would raise outlays this year were in the Nordic region, Southeastern Europe, the British Isles, and the Iberian Peninsula.

Half of those surveyed said they would use capital investments this year to expand operations, with over a third planning to spend their money for streamlining and minimising costs; 12.1% said they were focused on replacing equipment. More than 65% of Italian companies reported that they want to invest in expansion, followed by 60% in German-speaking Europe. Over half of Southeastern European firms said they were focused on streamlining and cost reduction.

At this point, it's a given that the coronavirus has shaped the concerns of the European plastics industry over the past two years. In 2021, the second year in which the world economy was slogging through the pandemic, companies in the plastics industry cited the cost of materials and feedstock availability as the top two concerns, with energy prices in the third position. As reported by PIE in July 2021, in the first half of last year, the major concerns were exactly the same and seem to be competing for the top spot. Other major issues quoted by several companies were logistics costs, shipping woes, sales volumes, staff recruitment, and salary costs.

In Italy, nearly 98% respondents said both material costs and feedstock availability were their biggest concerns, followed closely by Spain & Portugal at some 90% for material costs, and France at 95.2% for feedstock availability. It is hardly surprising that 100% of respondents from the plastics machinery industry reported material prices as their main issue. About 93% of the brand owners, on the other hand, said feedstock supply remained their biggest worry in 2021. In the first half of 2021, nearly all plastics producers, compounders, distributors, and product traders had complained about the lack of availability for feedstocks. To underline the obvious, these problems also remain the top two concerns for 2022.

Rising energy costs also reared their ugly head in the expectant worries for 2022, with the most concern coming from the plastics recycling industry and brand owners. Climate action programmes, in contrast, failed to rank among the highest challenges for the industry this year.

Despite all the other concerns, circular economy remains a big issue for Europe's plastics industry – with multiple challenges and just as many opportunities. The 7th PIE Readers Survey asked companies what they see as the main drivers of their climate action and resource efficiency measures. A good third of the respondents said customers, suppliers and competitors are the main drivers of their environmental activities. Only every fifth company seems to be self-driven enough to be acting out of its "own drive".

*Business performance forecast in the European plastics industry*

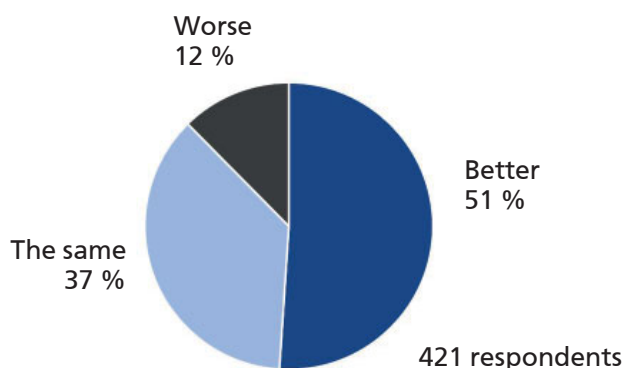

## New Packaging Valley Member

■ ILLIG Maschinenbau has become a new member of Packaging Valley Germany e.V., the world's most innovative packaging industry cluster, headquartered in Waiblingen with an additional office in Schwäbisch Hall. The cluster networks around 100 companies with more than 30,000 employees. These include manufacturers of packaging systems and machines, providers of software and automation solutions, component manufacturers, service providers, and public institutions.

The companies in Packaging Valley are always one step ahead of the future and offer the market the best technologies in the field of packaging machinery. With an export share of over 80%, the technological diversity from Packaging Valley is represented all over the world. International market leaders from the food, beverage, confectionery, pharmaceutical and cosmetics sectors are represented among the wide range of customers.

With "Circular Thinking!", ILLIG bundles many years of technical know-how into the development of sustainable systems. The company supports packaging manufacturers in the design of recyclable applications with "Pactivity® 360", a holistic approach to package development.

"Circular Thinking!" solutions support the circular economy and the related goals of reduce, reuse, separate, recycle and renew. Optimized packaging can reduce the use of raw materials and make recycling possible in the first place. This "design for environment" principle can be seen on the market today in the form of ILLIG's I-PACK®, a novel combination of plastic and paper, which reduces plastic use by 50%.

■ ILLIG Maschinenbau GmbH & Co. KG  
[www.illig.com](http://www.illig.com)

## New Long Fiber-Reinforced Thermoplastic is Made of Regenerated Cellulose for Lighter Weight and Higher Strength

■ Polyplastics Group has announced the introduction of PLASTRON® LFT resin which is made of specially formulated regenerated cellulose fibers. The eco-friendly PLASTRON® LFT provides weight reduction plus mechanical strength, enabling manufacturers to reduce their carbon footprint and meet today's sustainability demands.

Eco-friendly resins that incorporate natural fibers, starch, wood powder, and other plant-based and natural mineral filling materials are being considered for use in a broader range of applications. Cellulose is a promising material to help reduce CO<sub>2</sub> emissions but its insufficient strength is a limiting factor. Polyplastics has addressed this problem by using regenerated cellulose in the development of LFT

resins with an excellent balance of physical properties. Regenerated cellulose is natural cellulose spun into continuous fibers through wet spinning.

Since cellulose is highly insoluble in solvents, a large portion of regenerated cellulose fibers are manufactured through long and cumbersome processes. Simplifying these processes would likely lead to a further reduction in CO<sub>2</sub>. Polyplastics has developed regenerated long-fiber cellulose materials via a solvent method – a simple manufacturing process that emits very little CO<sub>2</sub>. Since this method involves a closed process that recovers virtually 100% of the solvent, it generates hardly any waste and produces materials that are even more eco-friendly. The company has earned multiple patents for this technology in Japan and internationally.

A comparison of long-fiber cellulose-reinforced PP resin versus long-fiber glass-reinforced PP resin at the same flexural modulus shows that cellulose-reinforced resin has lower density than glass-filled resin. While long-fiber cellulose-reinforced PP resin has a flexural modulus roughly 3% higher than that of 30% glass-reinforced PP resin, it exhibits higher values for Charpy impact strength, tensile strength, and flexural strength, thus indicating potential for upgraded strength.

(Source: Polyplastics Co., Ltd.)



\*PLASTRON® is a registered trademark owned by Polyplastics Co., Ltd. in Japan and other countries.

■ Polyplastics Co., Ltd.  
[www.polyplastics-global.com/en/approach/10.html](http://www.polyplastics-global.com/en/approach/10.html)



## First-Ever Female Duo Leads PLASTICS Marketing Efforts for NPE2024

■ The year was 2015, and the Plastics Industry Association was coming off one of the most successful trade shows in its history – the 2015 edition of its triennial NPE: The Plastics Show. NPE2015, held in Orlando, Florida in May, drew over 65,000 visitors, an almost 20% increase over its 2012 attendance. In December of that year, when the association met to begin discussions and planning for NPE2018, two women were added to the Sales & Marketing Committee.

While that fact did not get much attention at the time, it is making news today. That's because those two women, Annina Donaldson and Tammy Straw, are now not only the Chair and Vice Chair of the NPE2024 Sales & Marketing Committee – they are also the first-ever female duo to lead any NPE committee in the show's 75-year history.

In a recent interview, Donaldson, of Maxi-Blast Inc. of South Bend, Indiana, and Straw, the Marketing & Business Development Manager for ENTEK Manufacturing of Lebanon, Oregon, talked about their roles and their goals; goals which include building enthusiasm and ultimately, attendance for NPE2024, which will be the first NPE show in 6 years. NPE2021 was cancelled due to concerns about the spread of COVID 19. Both Donaldson and Straw have substantial plastics industry experience.

Donaldson was named Vice President of Florida Operations for Maxi-Blast, Inc. in January 2006, when her father, company founder Robert Donaldson, decided to pursue retirement. Now President of Florida Operations for Maxi-Blast, she works with her brother, other family members and employees in St. Petersburg, Florida where she focuses on managing the company and its Engineered Thermoplastics line of blast media for plastics and rubber cleaning processes.

"I grew up in the plastics industry," Donaldson said. "After graduate school and testing out other jobs, my father asked me to interview for a full-time job working alongside him and eventually taking over. I officially joined the company in 2006."

Straw started at ENTEK in 1999 with no idea that she would be beginning a long and successful career in the plastics industry.

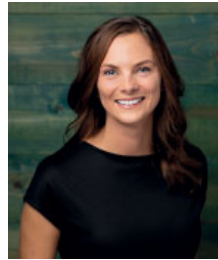

Annina Donaldson



Tammy Straw

"I was looking for a short-term job at the time, which has turned into a great career of 22 years and counting in plastics," she said. Straw heads up marketing and business development for ENTEK Manufacturing, a leading manufacturer of twin-screw extruders, aftermarket spare parts and turnkey extrusion manufacturing plants.

### Goals for NPE2024

As Chair and Vice Chair of the NPE2024 Sales & Marketing Committee, Donaldson and Straw are charged with leading the efforts to generate excitement and ultimately, attendance for the event. They oversee a committee that has a total of 13 members from a variety of large and small companies representing processors, equipment manufacturers and materials suppliers. The committee manages a large and diverse set of marketing projects, from advertising, public relations and social media campaigns to outreach campaigns designed to attract both show exhibitors and attendees.

Coming off the first-ever NPE show cancellation in 2021 provides a unique set of challenges for the NPE2024 committees. Donaldson, who was Vice Chair of the NPE2021 Sales & Marketing Committee, is optimistic that the next show will be a big success. "Our industry wants and needs to get back to exhibiting and attending at NPE and other in-person shows," she said. "NPE has always been an important event on the global plastics industry's calendar, and we are working hard to make May 6-10, 2024 in Orlando the best NPE yet."

► <https://npe.org/>  
 ► [www.next-step.com](http://www.next-step.com)

## New Line in Italy for Specialty, Technical Rubber Customers

■ Orion Engineered Carbons, a specialty chemical company, began commercial sales in Italy from the first new reactor for carbon black production to be commissioned in the European Union in over 40 years.

The new 25-kiloton line at the facility in Ravenna, in the northern region of Emilia-Romagna, produces both specialty and technical rubber carbon blacks, primarily for the European market.



"The new line offers customers seeking long-term solutions a unique strategic opportunity to align with a dependable plant that has been operating for more than 60 years in Europe," Orion CEO Corning Painter said.

Additional investments at the plant include a new co-generation facility to convert waste heat into electricity, generating up to 120 MWh of electricity per year. Seventy percent of the electricity is supplied to the national grid, serving about 30,000 households. Orion is a net exporter of electricity in Europe and worldwide.

► Orion Engineered Carbons  
 ► [orioncarbons.com](http://orioncarbons.com)

## New 800 Series Hybrid Extrusion Tooling Announced

■ Guill announces the introduction of a new version of its popular 800 series, known as 800 Series Hybrid. In some extrusion applications that utilize crossheads and inlines, layers of the exact same material are applied multiple times, using a single die. This method is used to reduce the propensity for errors caused by gels breaking through a thin wall, weld lines, inconsistent wall thickness, plus material and process variations. Additional errors include difficult-to-process materials and demanding applications where there is zero fault tolerance.

Seeking to design the next generation multi-layer die to overcome these challenges, the engineers at Guill looked for a way to incorporate this technology into an updated version of the 800 Series. This led to the creation of the 800 Series Hybrid. The inherent benefits of the 800 Series are retained, including compact design, low residence time and a common deflector bore that eliminates tolerance stack up. The challenge was to create a hybrid design that incorporates the benefits of layer overlapping, while reducing unnecessary complexity and making the technology more cost-affordable for customers. This was achieved by overlapping layers in each semi-deflector, using a single cone. The highly efficient design of the 800 Series Hybrid reduces cost and size, as opposed to other methods of overlapping layers.

Essential benefits of the 800 Series Hybrid include eliminating weld lines in materials through patented overlapping technol-

ogy, producing a more consistent finished product; reduced sensitivity to changes in viscosity; reduced sensitivity to changes in line speed; myriad material and multi-layer application possibilities; works in all tubing and jacketing applications with a wide range of materials; low residence time; compact design and a low tolerance stack-up error factor, all resulting in improved concentricity.

The 800 Series Hybrid extrusion tool greatly reduces stagnation, because overlapping layers are more inherently balanced than single layers and also because each semi-deflector is "tuned to flush." Conventional deflectors must simultaneously achieve a balance between flushing, balancing and eliminating the weld line. There is less difference between the slowest moving material and the fastest moving material in the deflector channels, thus making the viscosity more consistent in the deflector.

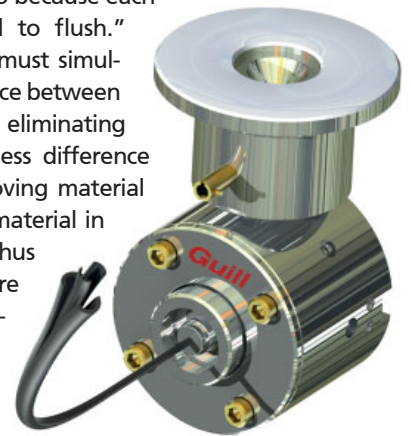

► Guill Tool & Engineering  
[www.guill.com](http://www.guill.com)

## New High-Output Pulverizer Expands Capacity for PVC Extruder

■ The installation of a newly launched Pallmann PKM800 pulverizing system has enabled a leading manufacturer of PVC extrusions to expand capacity. The new pulverizer from Pallmann Industries, a leading global supplier of size reduction equipment for the plastics industry, delivers greater throughput, increased productivity, reduced material cost, and greater cleanliness for products made of PVC.

In response to the booming building and construction market, the PVC extruder needed to boost capacity to meet growing demand. The high-performance PKM800 pulverizer converts PVC scrap and delivers 2000 lb/hr of recycled PVC at 20 mesh (840 micron) particle size. These recycled powders are mixed with virgin PVC material and are re-entered into the profile extrusion process.



The PKM800 pulverizer outperforms the previous competitive model by 2 to 1 in terms of production, according to Jeff Taylor, vice president of sales for Pallmann Industries. "We're thrilled we could supply a key customer with a cost-effective solution with minimal energy requirements and maintenance, while at the same time providing a cleaner work environment," said Taylor.

The PKM800 is safer and cleaner than competitive models thanks to a pulse jet enclosed bag housing that contains the dust. Unlike typical hanging filter bag plenums, the PKM800 blows air and discharges the dust downward into a container. The pulverizer also delivers uniform particle size distribution for production of more intricate and detailed profiles. High-quality powders can be produced and blemishes and pits are reduced in finished parts.

The PKM800 pulverizer features "segment" cutting technology which provides different serrations for different applications, unlike grinding rings which have limited serrations due to narrow inlet tooth distances. Segments offer a real scissor-cut action, affording better utilization of cutting energy, less heating, reduced fines, and adaptability to many materials. Pallmann pulverizers are made of strong weldments instead of standard castings and thus provide exceptional durability with many pulverizing systems boasting over 30 years of service.

► Pallmann Industries  
[www.pallmannindustries.com](http://www.pallmannindustries.com)

## PLASTPOL 2022

■ Already 500 exhibitors have registered for this year's 26th PLASTPOL. This year's event promises to be really important for the whole business sector – not only the market players in Poland.

For a quarter of a century, the PLASTPOL has been Central and Eastern Europe's focal meeting point for business insiders, the dialogue platform for domestic and global companies active in the plastics processing sector. Last year's Targi Kielce's show hosted exhibitors from many countries, including Italy, Austria, Czech Republic, Portugal and Qatar. Every year abounds with companies' presentations of cutting-edge

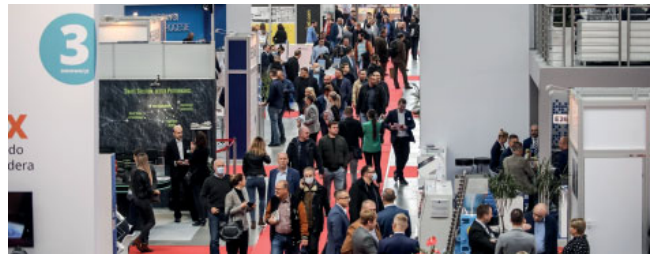

machinery and components, such as injection moulding machines, extruders for plastics, granules and many more.

► [www.targikielce.pl/en/plastpol](http://www.targikielce.pl/en/plastpol)

## New Research Report

■ A new report from Finland's Technical Research Center (VTT), "Recycling Food Packaging", highlights those technology solutions expected to become commercially available in the next five years and says partnerships are essential to deliver the necessary technological innovations in food packaging recycling.

VTT's team examined current and near-future recycling systems for plastic and fiber packaging and found that alliances between brand owners, recycling and sorting technology developers, and waste management companies are fundamental to the development of recycling solutions. Such partnerships are essential for future investment in new recycling technology as they provide, on one hand, accessibility to used material, and on the other hand, a potential user for the recycle. Commissioned by Huhtamaki the global sustainable packaging solutions provider, the report aims to identify and increase understanding of the key drivers required to deliver a functioning circular economy, in which importantly packaging is not only recyclable, but recycled.

"The study predicts a significant increase in industrial chemical recycling capacity in the United States, Europe and East Asia in the next 3 to 4 years. Chemically recycled polymers can be included in food packaging after full depolymerization, whilst in practice today, recycled polymers certified as food contact material are mainly limited to rPET, used mostly in bottles", says Mona Arnold, principal scientist at VTT.

Huhtamaki has an ambitious 2030 sustainability agenda, including a commitment to design 100% of its products to be recyclable, compostable or reusable. The company also aims to have more than 80% of raw materials it uses to be either renewable or recycled. To deliver on these, Huhtamaki needs to ensure that the packaging materials, which provide access to safe, affordable foods and help prevent food waste, are recycled after use in ways that maximize their value to both the planet and people, and therefore help deliver a low carbon circular economy.

The report is available for download at [bit.ly/37NoQ2O](https://bit.ly/37NoQ2O).

► **Huhtamaki**  
[www.huhtamaki.com](http://www.huhtamaki.com)

## Cooperation

■ BASF has signed a strategic cooperation agreement with Zhejiang REEF Technology Co., Ltd. to develop state-of-the-art recycle formulations for applications used in the automotive, packaging and consumer industries.

Under the agreement, BASF will provide its recently launched IrgaCycle™ additive solutions along with technical consultancy and support for recycled polymer formulations conducted at BASF's test facilities.

"Our goal is to help deliver higher quality, safer and more effective products while supporting the plastic circular economy and helping reduce the use of virgin plastic material," says Hermann Althoff, Senior Vice President, Performance Chemicals Asia Pacific. "In this way, we support our customers and partners to achieve their sustainability targets and create sustainable innovations together."

IrgaCycle™ additive solutions help to increase the percentage of mechanically recycled content in several end-use applica-

tions such as packaging, automotive & mobility, and building and construction. These solutions address specific quality issues associated with recycled resins, such as limited processability, poor long-term thermal stability and insufficient protection from outdoor weathering.

The IrgaCycle range is offered as part of the VALERAS™ portfolio. In addition to enabling plastics circularity with IrgaCycle, VALERAS solutions bring significant sustainability value to plastic applications by improving durability, reducing waste, saving energy, reducing emissions, and promoting biodiversity.

Zhejiang REEF Technology Co., Ltd. is a subsidiary of Veolia Huafei Polymer Technology (Zhejiang) Co., Ltd., a joint venture company of the French Veolia Group in China. It focuses on the R&D and production of high-end engineering plastic modified materials. REEF's core products include recycled polypropylene, high density polyethylene, ABS, and polyamide.

► **BASF Plastic Additives**  
[www.performancechemicals.basf.com](http://www.performancechemicals.basf.com)

## Nonwovens and Converting Solutions at Techtextil North America

■ Davis-Standard will market the company's nonwovens and converting solutions technology at booth #2604 during Techtextil North America on May 17- 19, 2022, in Atlanta, Georgia. Davis-Standard offers a range of performance technology for high-volume fabric coating applications and engineered textile composite applications. This includes extruders, controls, feedscrews, unwinds and winders, laminators, extrusion coaters, and web handling equipment. Davis-Standard will also promote the company's new DS Activ-Check™ cloud-based platform as well as R&D opportunities.

In the area of fabric coating, Davis-Standard will highlight its high-output CHP extruder. This extruder offers flexibility and added functionality via feedscrew and other extruder station related changes for different high volume market applications. High volume applications include lumber wrap, underlayment, house wrap, membranes, industrial goods packaging, and industrial food packaging. Processors can extrude LDPE, LLDPE, and PP blends in a variety of structures with in-line speeds up to 1500 feet per minute (450 mpm) and web widths up to 160 inches (4 meters). The CHP accommodates existing carriage or platform structures and can easily fit into tight spaces for retrofits, coextrusion additions, and as a replacement extruder to increase output and line speed. Rates are 80 to 100 percent higher than conventional extruders with improved quick-change capabilities and reduced purge time. Davis-Standard's in-line extrusion coating and laminating machinery supports consistent and reliable adhesion for high-value engineered textile composite applications. Applications include chemical-resistant garments, footwear, protective outerwear, and multiple products for the aviation, marine, and membrane industries. Davis-Standard's coaters and laminators can support widths up to 126 inches (3.2 meters), line speeds up to 330 feet per minute (100 mpm), and roll diameters up to 40 inches. This includes technology for PET and PA woven substrates with TPU, TPO, PA, and Hytrel blends. In addition, coaters are capable of coating one or both sides of the web for product adaptability. Applying the primer in-line has been advantageous in helping converters avoid a secondary process while also providing in-house quality control and intellectual property protection.

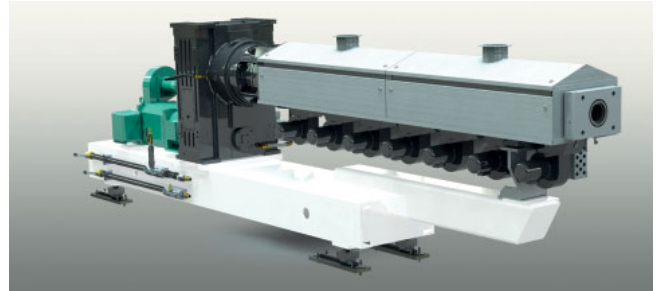

*The new CHP extruder is a space-saving, high-performance option for a range of extrusion coating applications*

Davis-Standard has demonstrated expertise in designing machinery for the circular economy. This includes mono-material structures, biodegradable resins, increasing recycled content, adding functionality with twin-screw technology, edge trim recycling, and energy-saving design features. With more than 50 standard and custom liquid coating products, Davis-Standard is experienced in attaining the right viscosity, emulsion, pH, and adhesive characteristics for customer applications. This includes tapes and labels, silicone-coating products, paint protection films (PPF), and specialty coating markets. The company can address low to high-speed applications, narrow and wide applications, simple lines with a dedicated coater, and complex coating lines with multiple cartridge coaters.

One of Davis-Standard's most exciting developments is the launch of its DS Activ-Check™ system. Davis-Standard's Industry 4.0 platform for continuous monitoring, preventative maintenance and mobile alerts. DS Activ-Check™ uses analytical tools based on long-term cloud data storage, along with process and equipment technology algorithms, to help management and production teams identify and improve product quality and line productivity. Customers can run trials using DS Activ-Check™ at Davis-Standard's R&D facility in Pawcatuck, Conn.

■ Davis-Standard, LLC  
[www.davis-standard.com](http://www.davis-standard.com)

## RPET/PET Capacity to Beaver Site Added to Further Grow Sustainable Healthcare and Food Packaging Market in North America

■ Klöckner Pentaplast (kp), a global leader in recycled content products and high-barrier protective packaging, has chosen its production facility in Beaver, West Virginia for its multi-million dollar production expansion, adding post-con-

sumer recycled content (PCR) PET capacity in North America.

This expansion will further grow kp's sustainable innovation offering in consumer health, pharmaceutical, and food

packaging markets through the addition of an extrusion line and two thermoformers, delivering a total of 15,000 metric tonnes of new rPET/PET capacity. kp currently leads the industry with over 20% of its volumes made from PCR material.

Scott Tracey, kp's Chief Executive Officer states, "The expansion responds to continued demand for sustainable options from our food packaging, pharmaceutical, consumer and label film customers. The extrusion line will support production of important sustainable product lines such as kpNext™ recyclable pharmaceutical blister films, and Smartcycle® recyclable label and consumer packaging films. The thermoformers will produce award winning kp Elite® mono-mate-

rial protein trays which are made using up to 100% recycled PET and are easily recycled creating a circular economy."

The addition is part of kp's continued North America expansion plans. The state has committed to local grants and incentives for the placement. The installation will add 60 jobs to the West Virginia facility with commercialization beginning at the end of 2022 for the first thermoform line. The extrusion addition will be completed in mid-2023. The completion of the second thermoform line and new production hall, which will be capable of additional capacity expansions in the future, is scheduled for the end of Q4 2023.

► Klöckner Pentaplast  
www.kpfilms.com

## Sustainably Produced Compounds

■ SER North America is the second US plant built in Anderson, Indiana, by the Italian Sirmax Group, a sustainable producer of polypropylene compounds, engineering plastics, post-consumer compounds and bio-compounds for a wide range of applications. SER North America, the Group's thirteenth plant, is entirely dedicated to the production of recycled polypropylene from post-industrial waste.

The new plant, which stands next to Sirmax North America (built in 2015), brings the plastic selection and processing models applied to post-consumer plastic in Europe to the US market. Its mission is to carefully select, shred, and regenerate post-industrial waste, and its flagship product is GREEN ISOPLLEN™, a polymer based on 100% regenerated polypropylene.

Incoming waste material is controlled at the source through stringent supplier selection and later processed to obtain high-quality output materials. SER North America's recycled polypropylene is intended both for industrial applications and to be processed by Sirmax North America as a secondary raw material for hybrid compounds marketed under the GREEN ISOFIL and GREEN ISOGLASS brands. These materials contain mineral fillers or are reinforced with glass fiber and are intended for the production of durable goods for the household appliance and automotive sectors. Though their performance is equivalent to high-grade compounds, they contain varying percentages of green material (depending on client specifications), which ensure they have a lower environmental impact.

"SER North America marks a new stage in Sirmax's sustainable growth," states Lorenzo Ferro, US country manager at Sirmax Group. "These new green products give us the opportunity to enter sectors where we do not yet have a presence, such as industrial packaging or garden furniture. Our production processes and the fact we have full control of supply sources also means that we are ready to bring post-consumer mechanical recycling technology to the United States by 2024. The vertical integration we have undertaken with SER allows us to differentiate ourselves in the market and meet Sirmax client demands for more sustainable materials in the automotive and household appliance sectors – all

without compromising on traceability and the high quality standards required for premium materials, which are already being supplied today."

Post-consumer mechanical recycling technology means Sirmax products contribute to the reduction of CO<sub>2</sub> emissions. This is substantiated by a life cycle assessment (LCA) study commissioned to Spinlife, a company of the University of Padua (Italy), which showed that replacing virgin polypropylene with recycled waste material can often halve carbon dioxide emissions.

Sirmax has been working towards sustainability for years, and since last September, it has been working alongside UMass Lowell and MIT – two Massachusetts universities – on a research project funded by the ReMade Institute (part of the DOE, Department of Energy) entitled "Chemical Conversion and Process Control for Increased use of Polyethylene and Polypropylene Secondary Feedstocks". UMass Lowell, the top US university in the field of injection molding, is studying a model for recycling polyethylene and polypropylene industrial waste for correct reuse in the packaging industry. With an investment of \$100,000 per year, Sirmax Group is the only non-US company partnering with the project. Other participants include giants such as Procter&Gamble. In light of the USA's increased focus on green policies, the purpose of the project is to provide the knowledge and technology needed to accelerate the implementation of good recycling practices and promote a culture of urban waste sorting.

"The pandemic has determined a change of pace," said Sirmax Group president and CEO Massimo Pavin, "as evidenced by the 43 million dollars invested at the federal level to initiate as many as 24 projects engaging in the research of new technologies to reduce energy consumption and decrease emissions. Among these is the UMass project in Lowell, selected by the Remade Institute. In addition to its economic commitment, Sirmax will contribute by providing knowledge and by making its laboratories available for recycling tests."

► Ser North America – Sirmax Group  
www.sirmax.com

## Personalia

■ Giovanni Spitale has been named Chief Executive Officer of Davis-Standard, a portfolio company of Gamut Capital Management. Giovanni Spitale replaces Jim Murphy who has been elected as Vice Chairman of the Board of Directors. In addition, Davis-Standard has elected several individuals as members of its Board of Directors, including Brian Marston, Bill Barker and John McGrath, each of whom have significant experience within Davis-Standard's markets.

"I am extremely excited to join the Davis-Standard organization," said Spitale. "Having spent considerable time in the polymer processing and broader capital equipment industries, I have long admired Davis-Standard's leading position in the market, its unmatched engineering capability and the Company's reputation as a strong partner to its customers through both original equipment and after-market support. I look forward to working with the Davis-Standard organization to continue to grow the business globally and support our world-class base of customers with differentiated product offerings and services."

"I want to thank the entire Davis-Standard organization for the many years of strong performance that we have collectively executed upon under my tenure as CEO," said Murphy. "I am thrilled to continue to serve the Company as Vice Chairman of the Board of Directors and look forward to collaborating with Giovanni alongside the broader Board of Directors in this next and very exciting phase of Davis-Standard's long history."

Alongside Spitale and Murphy, the Davis-Standard Board of Directors includes Dan Guthrie, Chief Operating Officer of Davis-Standard, representatives from controlling shareholder Gamut Capital Management, as well as Brian Marston, Bill Barker and John McGrath. Marston is currently President & CEO of Uniloy and was previously President of the Blow Molding and Extrusion businesses of Milacron. Barker was previously the President and CEO of Mold-Masters. McGrath was previously the CEO of Pactiv Evergreen.

► Davis-Standard, LLC  
www.davis-standard.com

## TCO Certification Received

■ FRX Polymers has announced that the Company's Nofia® branded polymeric phosphorus-based flame retardants, Nofia® Homopolymers and Copolymers, have been added to the TCO Certified Accepted Substance List. TCO is the most recognized and world-leading sustainability certification for additives in the electronics and information technology industries. Only flame retardants on the widely used TCO Certified Accepted Substance List may be used for TCO Certified Products.

Marc Lebel, CEO of FRX Polymers, stated that, "This news from TCO confirms that Nofia flame retardants are ideally suited for use in electronics equipment to replace halogenated flame retardants that will no longer be allowed." Lebel continued, "Once again, it is confirmed that OEMs,

retailers, and the general public do not need to compromise on sustainability in order to be protected from the catastrophic risks of fire."

The European Court of Justice ruled on March 16, 2022, that a ban on halogenated flame retardants in enclosures and stands of TVs and monitors, is in conformity with European law. FRX has developed a line of patent protected products under its Nofia® brand that address the very real and significant problem around the use of certain harmful chemicals that are currently used as flame retardants in several industrial and consumer applications. FRX has been built on over \$US120 million of investment and is positioned to be a leader in the transition to environmentally friendly solutions within the \$US30 billion flame retardant plastics industry.

► FRX Polymers  
www.frxpolymers.com

## US-Based Sulfone Polymers Business Expanded

■ Solvay announced an ambitious expansion plan for its U.S.-based sulfone business, which focuses on polymer solutions for various critical life science applications, as part of its ongoing commitment to build capacity in this field to support a growing global customer base.

The full scope of the multi-year expansion plans will ultimately touch all of Solvay's sulfone polymers including Udel® polysulfones (PSU), Veradel® polyether sulfones (PESU) and Radel® polyphenyl sulfones (PPSU). The first major investment steps will include a capacity increase for Udel® PSU of

over 25% by 2024 at the company's production site in Marietta, Ohio, with much of this increase expected online by early 2023. Likewise, to strengthen Solvay's leading position in the market, production capacity for dichlorodiphenyl sulfone (DCDPS) – an important common building block used in all sulfone polymers – will also be expanded by more than 25% by 2024, resulting in capacity increases at the company's Augusta, Georgia site by end of 2022.

"This new multi-year program marks an important step in our strategy for future growth and affirms our number one

position in the U.S. sulfone polymers market," says Carmelo Lo Faro, president of Solvay's Materials segment. "Essentially, the expansions will address the growth potential of our sulfone products in high-performance life-saving and life-sustaining areas, such as healthcare, water purification and pharma processing."

Key application market segments to benefit from these investments include hemodialysis, medical instruments and pharmaceuticals – in both development and production, and water purification, where Solvay expects strong double-digit growth in terms of global demand. Moreover, high-performance sulfone polymers also play a growing role in residential and commercial heating and plumbing systems.

Solvay has announced a major expansion plan to boost its production capacity for sulfone polymers in support of a growing global customer base in life-saving and life-sustaining application markets. First steps in this initiative will add more than 25% of capacity for both Udel® polysulfones (PSU) and basic dichlorodiphenyl sulfone (DCDPS) at the company's production sites in the United States by 2024.

\*Note: Udel®, Veradel® and Radel® are registered trademarks of Solvay.

 Solvay  
www.solvay.com

## Automated Six-Axis Case Packer for Lid and Container Packaging Introduced

■ Muller Technology, a leading global supplier of molds and automation solutions for thin-wall packaging, has announced the launch of an automated six-axis case packer for high-volume production of lid and container packaging. The new automation product, which incorporates an industrial six-axis robot, helps to meet the volume-driven demands of U.S. processors while also delivering greater versatility, flexibility, and productivity.

The six-axis case packer delivers greater productivity than Muller's recently launched collaborative robot (cobot) case packer, according to Taras Konowal, Muller's Director of Sales and Marketing for North America. "The unit is one of our most productive systems for high-volume packaging lines," said Konowal. It offers higher cavitation for the manufacture of blow molded bottles

and thermoformed packaging. The unit offers highly efficient cycle times, handling up to 64 cavities every six sec for lids and 5-sec cycles for containers.

The case packer can be purchased separately or integrated into an automation.

The new six-axis case packer offers portability, quick part changeover for different size configurations, and a favorable return on investment. It comes with external guarding and is equipped with all the latest safety features. The product platform will be manufactured in Switzerland and Colorado. Muller has already sold several units for lids and containers in the U.S. and Canada.

 Muller Technology Colorado (formerly CBW Automation)  
www.muller-technology.com

## Expansion

■ SI Group announced that it has increased production capacity for ETHANOX™ 4716 and NAUGARD™ PS48 hindered phenolic ester antioxidants at its Jinshan, China facility. The new capacity is now operational.

The capacity expansion will help address the growing demand for antioxidants in the lubricants and plastics industries in Asia-Pacific and further strengthens SI Group's position as a key partner to its customers. Joey Gullion, Chief Commercial Officer, commented: "Our investment demonstrates SI Group's commitment to supporting our customers' growth in both the lubricants and plastics industries and is aligned with our brand promise to deliver the solutions they need with increased security of supply."

SI Group has a long history of manufacturing antioxidants for use in industrial lubricants, automotive fluids, and engine oils. ETHANOX™ 4716 is an easy-to-handle liquid antioxidant, with low volatility designed for use in high-temperature applications.

The company also has a broad portfolio of chemistries and innovative solutions for the polyol and polyurethane industries. NAUGARD™ PS48 stabilizer is a liquid phenolic antioxidant that provides excellent protection against degradation across many polymer applications.

This expansion follows an earlier announcement by SI Group to invest more than \$50 million across three manufacturing sites to install globally competitive main antioxidant capacity in North America.

 SI Group  
www.siigroup.com

## 2022 Sustainability Innovation Award Winners

■ The Plastics Industry Association (PLASTICS) has announced the winners of their 2022 Relfocus Sustainability Innovation Awards. Presented annually, the awards recognize companies that are driving environmental advances in product design, sustainable materials and end-of-life recovery of plastics.

The panel of judges for the 2022 awards included Kyla Fisher of Three Peaks Consulting, Ron Vance of the U.S. Environmental Protection Administration, and Lilli Sherman of Plastics Technology Magazine.

"We're grateful to our panel of expert judges for lending us their time and talent," said Tony Radoszewski, President and CEO of PLASTICS. "This is one of my favorite PLASTICS programs, because it gives companies an opportunity to prove that our industry is walking the walk when it comes to sustainability and protecting the environment."

The award for Sustainability Innovation in Design goes to Klöckner Pentaplast, for kpNext™ R1, the first pharmaceutical blister film designed to be recycled in the RIC 1 recycling stream. Where pharmaceutical blister films are typically produced from materials that are not readily recyclable, kpNext™ R1 is produced from a special PET formulation that allows it to be fully recycled in the same curbside recycling stream as plastic water bottles.



*Klöckner Pentaplast's easily recycled kpNext™ R1, pharmaceutical blister film*

In the Sustainability in Materials category, the 2022 winner is Starlinger visotec for rPET100, a heat-resistant and fully recyclable sheet material for thermoformed packaging that can be made from 100% recycled content and then recycled again while maintaining high quality in strength and appearance. Containing only natural-based mineral fillers, there are no stabilizers or polymer additives to prevent recycling in the existing food packaging loop.

The 2022 Sustainability in End-of-Life Award winner is JP Industrial for its proprietary AERO Screening Technology that converts waste PVC into a high-grade PVC powder that can be used in a variety of quality applications. The process also captures and reuses material traditionally lost in the scrap recycling process. This material has been used in a variety of applications and products, particularly in the building sector.

The fourth category in the Sustainability Innovation Awards is the People's Choice Award which, for 2022, is claimed by Novolooop, Inc. They impressed the public with Oistre™, the first thermoplastic urethane (TPU) made using advanced chemical recycling.

In addition to the main-category awards, PLASTICS also presented an award for overall Leadership in Sustainability Innovation. Ford Motor Company takes that title with three unique concepts – one involving closed-loop recycling, one featuring parts made from 100% recycled ocean plastic, and another showing the advantages of using nanocellulose to lighten the weight of vehicles while decreasing dependence on fossil fuels in the manufacturing process.

"Innovation and sustainability have become inextricably linked in the plastics industry," said Patrick Krieger, Vice President for Sustainability at PLASTICS, "We're seeing so many companies using plastics to improve the sustainability of so many other industries like food and the automotive industries."

The association will be celebrating the award winners at its Relfocus Sustainability & Recycling Summit, May 23-26 at Duke Energy Convention Center in Cincinnati, Ohio.

*Schematic for JP Industrial's AERO Screening Technology*

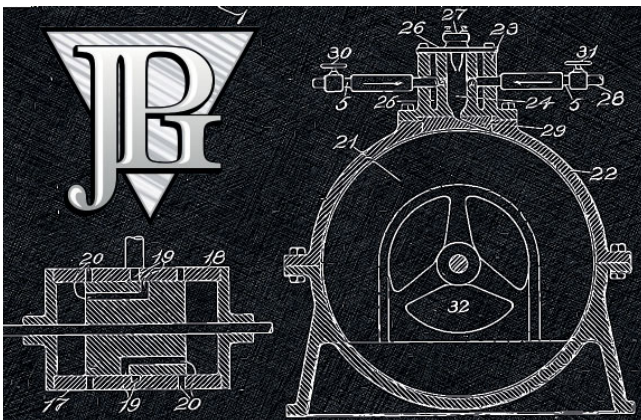

*Starlinger visotec's PCR-based, heat-resistant, easily recyclable rPET100*





## Broad Range of Sustainable Thermoplastic Elastomers (TPEs)

United Soft Plastics has announced the development of a series of sustainable thermoplastic elastomer solutions which meet the eco-conscious needs of brand owners and consumers. The TPEs – currently under different stages of commercial development – are produced from renewable, post-consumer, post-industrial, and bio-based sources.

“With the market clearly focused on a circular economy, we are committed to the development of unique and innovative products that reduce carbon emissions and deliver sustainability advantages,” said Rudi Herbst, President and CEO of United Soft Plastics. Market drivers include the emergence of state and federal legislation on single-use plastics and the firm commitment from various stakeholders including brand owners to meet aggressive sustainability goals during the next five years.

The first commercially available grades, based on styrene-ethylene-butylene-styrene (SEBS), are made from recycled post-consumer and post-industrial sources up to 100%. They provide typical soft touch, anti-slip properties along with adhesion and haptics.

Three other series of sustainable TPE solutions are currently under commercial development. These cost-effective

SEBS grades include renewable products, consisting of up to 70% of wood flour, rice hull, and/or hemp. They offer a limited performance threshold, which excludes use in highly engineered TPEs but they come with ample supply.

Other sustainable TPEs in the commercial development pipeline are biopolymers which utilize non-fossil-based materials with up to 100% content. These TPEs show the greatest promise in terms of market impact and carbon emission reduction, according to Herbst.

Rounding out the sustainable TPE portfolio are bio-hybrid TPEs which can combine renewable, post-consumer, post-industrial, and bio-based content up to 100%. USP’s product development efforts are centered at its manufacturing facilities in Lawrenceville, Ga., and Houston, Texas. The company is also conducting sampling and manufacturing trials with end-use customers in the consumer products and healthcare industries.

United Soft Plastics Inc. (USP)  
www.unitedsoftplastics.com

# SMART EXTRUSION

The only website collecting information about smart technologies of extrusion

34 600 + average monthly visits

Geographic distribution of Smart\_Extrusion readers, %

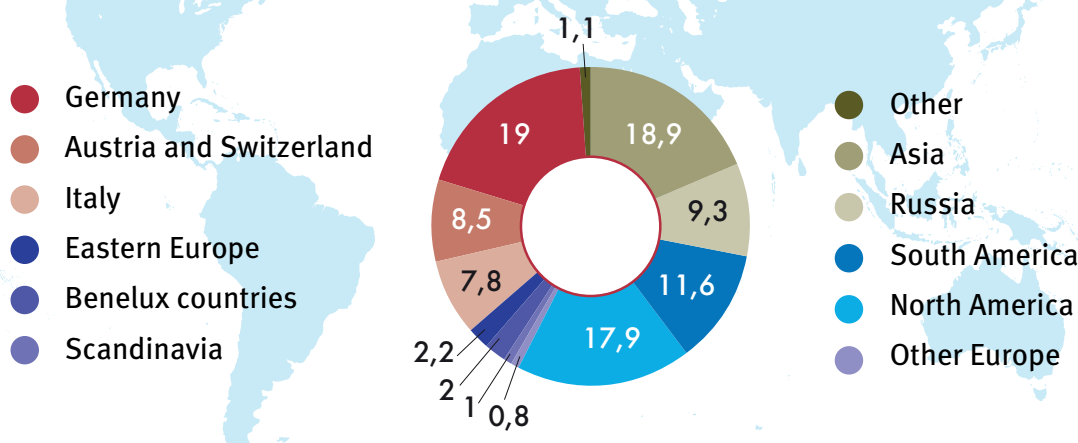

www.smart-extrusion.com

# Getting the Most from Your Extrusion Tooling

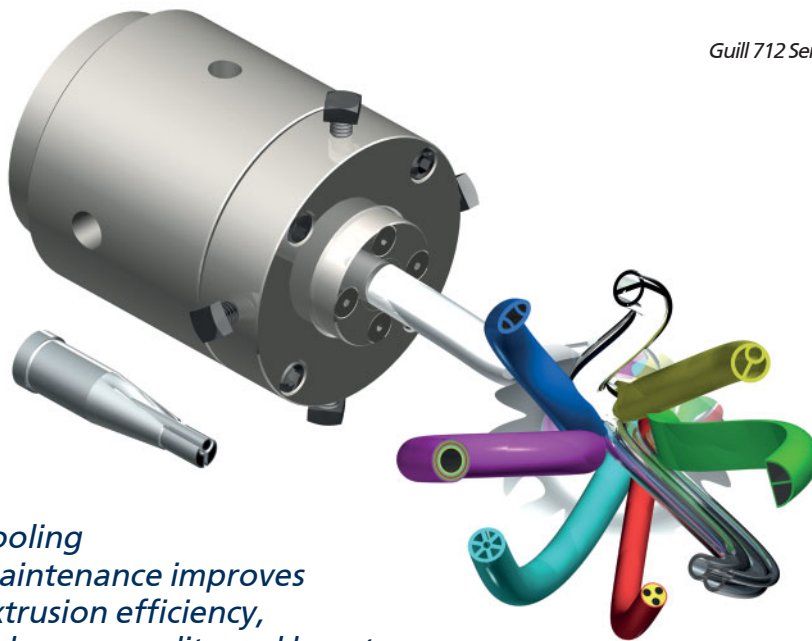

*Guill 712 Series*

*Tooling maintenance improves extrusion efficiency, enhances quality and boosts overall productivity for your medical tubing applications*

By utilizing state-of-the-art production equipment and processes, machining tolerances are held extremely close on today's multi-lumen and multi-layer medical tubing. It is important to note that any misalignment of the tools may be exaggerated in the final product output. Clean parts, especially with sealing and locating surfaces, are key to product performance and successful end products. These surfaces receive the most care and attention during manufacturing and are the control surfaces that ensure uniformity throughout the tubing. Remember, precision-machined alignments are affected by even a speck of dirt measuring only a few thousandths of an inch. A human hair is about 0.003" (0.08 mm), and since there are many such surfaces

in a quality tool, cleanliness is critical.

Checking of the tools for any deformities is also important. Burrs, scratches and scrapes are usually a result of careless handling and/or

storage of equipment. Double and triple-layer extrusion heads pose an even greater challenge for maintenance. The number of sealing and centering surfaces multiplies and can magnify the results of dirty tools. During changeovers, the head may be disassembled in order to change compounds and/or tips and dies. Foreign matter is usually introduced at this point and residual materials must be thoroughly removed. Physical tool damage often occurs during this phase, due to mishandling and poor storage techniques. These are highly precise parts, but can also be heavy and bulky to remove by hand. Use of a dedicated work cart exclusively reserved and equipped for extruder head maintenance is recommended. This cart along with a supply of spare components and hardware is easily justified, especially when examining the potential cost savings that result from well-maintained tools. The following should be considered: 1.) Maintain a clean, organized work area with soft and clean renewable work surfaces; 2.) Use a vise with soft jaws, such as copper; 3.) Use special equipment, such as tip removal tools, etc.; 4.)

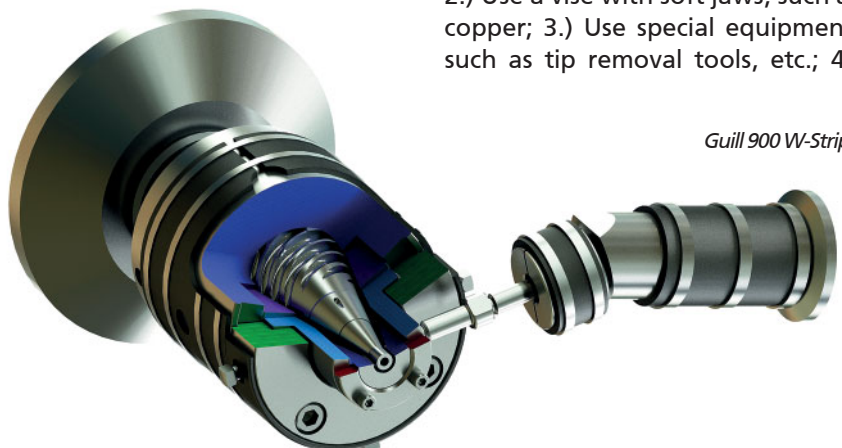

*Guill 900 W-Stripe*

Guill Kelpac

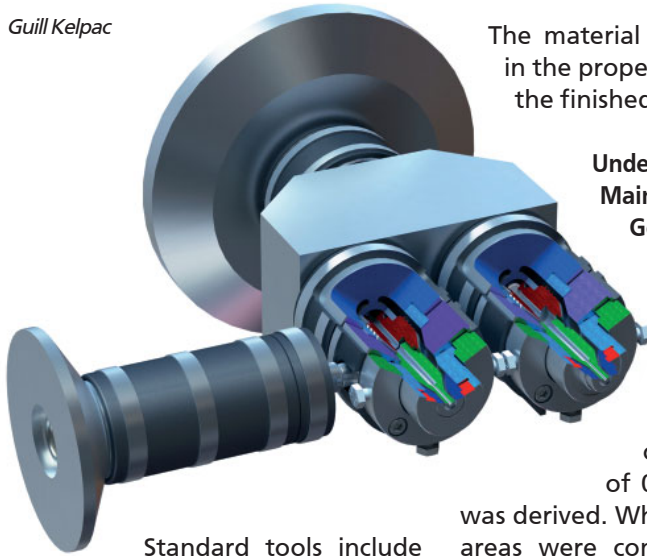

The material is then distributed in the proper location as part of the finished product.

#### Understanding Maintenance Procedures: Get Organized Before You Start

Example 1: In this example, with an improperly centered tool, a calculated out-of-tolerance area of 0.059 in<sup>2</sup> (38 mm<sup>2</sup>)

was derived. When the two surface areas were compared, the calculated material waste was 11.8% of the finished product. The formula is % wall = min. wall thickness, max. wall thickness X 100. Example 2: Alternatively, if the % wall can be increased from 80% to 95%, a savings of about 12% of total cost can result. Savings will vary depending on the designs, of course.

Get help for heavy parts and awkward situations. Surfaces and edges are hard and therefore somewhat brittle, so dropping a part or striking parts together can result in damage. Store your tools properly in a dry, clean area – a dedicated spot for each tool is best. These areas should have soft surfaces and each instrument should be covered after cleaning. Also, tools should be segregated so that they do not come into contact with each other. And tools and all instruments should be cleaned thoroughly before storage. For disassembly of tools, it is imperative to use purpose-built tooling to facilitate disassembly. These should be available from your supplier. If they are not, consult with a reputable tooling house for replacements. The cost of these tools is easily offset by potential damages, frequently caused by improper equipment such as hammers and drifts. Follow the guidelines outlined in your operator's manual. Individual tools may have specific recommendations, so contact your supplier if anything is unclear. Your supplier understands that optimum performance relies on proper care and maintenance. Here are some useful tips: 1.) Clean your equipment while it is still hot

Standard tools include wrenches, soft-faced hammers, etc.; 5.) Maintain a supply of soft, clean rags; 6.) Use cleaning solutions in spray bottle; 7.) Use spare parts as suggested by your tooling supplier, properly organized and stored; 8.) Keep handy your equipment's repair/maintenance manual; 9.) Have a small surface plate to provide a true flat surface;

10.) Use a set of appropriate gauge and tip pins for initial tool location adjustment; 11.) Make sure you have all the proper lifting aids available, including overhead hoists, hydraulic lifts, etc. In most situations, the head and tooling will still be at elevated temperatures, therefore lined gloves are needed when handling. Today, tubing manufacturers compete with companies all over the world. To be a successful and profitable company, quality and efficiency are essential. This is especially true in extrusion, where material costs are usually much higher than labor costs. Like a racing car stuck in the pit, many extruders sit idle because of poor or damaged tooling, plus excess maintenance time. Overhead costs add up and losing money is the result. Some start up quickly and make scrap, whereas others start up and run a product oversized to hold minimum tolerance. They waste 10% to 20% of the material, which can run from 50% to 90% of the product cost. The tooling supplier goes to great lengths so that tips and dies are machined to a determined specification, ensuring perfect concentricity and alignment.

as the residue is easier to remove. It helps to remove and clean one piece of tooling at a time in order to maintain elevated temperatures. 2.) When cleaning a dual compound crosshead, (plastic and rubber) clean the plastic tooling first; the rubber second. 3.) Never use steel tools such as scrapers or screwdrivers because these can scratch and mar the tooling. 4.) Do not use open flames because this generates excessive heat especially in thin sections, which can affect hardness, concentricity and tolerances of components. Recommended cleaning tools and materials include: a.) Brass pliers to grip material and aid in pulling; b.) Brass scrapers available in different widths for cleaning flat exposed surfaces; c.) Brass bristle tube brushes that are available in diameters from 1/16" to 1" in 1/16" increments (ideal for cleaning holes and recesses); d.) Brass rods – different diameter rods are good for pushing material out of flow holes; e.) Copper gauze for cleaning and polishing exposed round or conical surfaces; f.) Copper knives for removing residue from recesses and other hard-to-reach areas. Also, polishing compound restores polished surfaces; g.) Compressed air, which is more effective for releasing plastic, but also aids in rubber removal. Be careful not to force debris into recesses with compressed air; h.) Cleaning solutions may be useful, so remember to use fresh, clean rags (used rags often have metal chips embedded in them, which may scratch polished surfaces); i.) Cleaning oven – for plastic only. Follow manufacturer's recommendations. If no temperatures are specified do not exceed 850 degrees F (454 degrees C). Don't quench tooling to cool, as this could affect tooling hardness, concentricity and tolerances. j.) Purging compounds – several are offered to purge the extruder screw/barrel of residual polymer and rubber compounds.

#### Removing Excess Material for Optimum Machining Efficiency

Clean parts are critical to extrusion tooling performance and quality manufacturing. This is especially

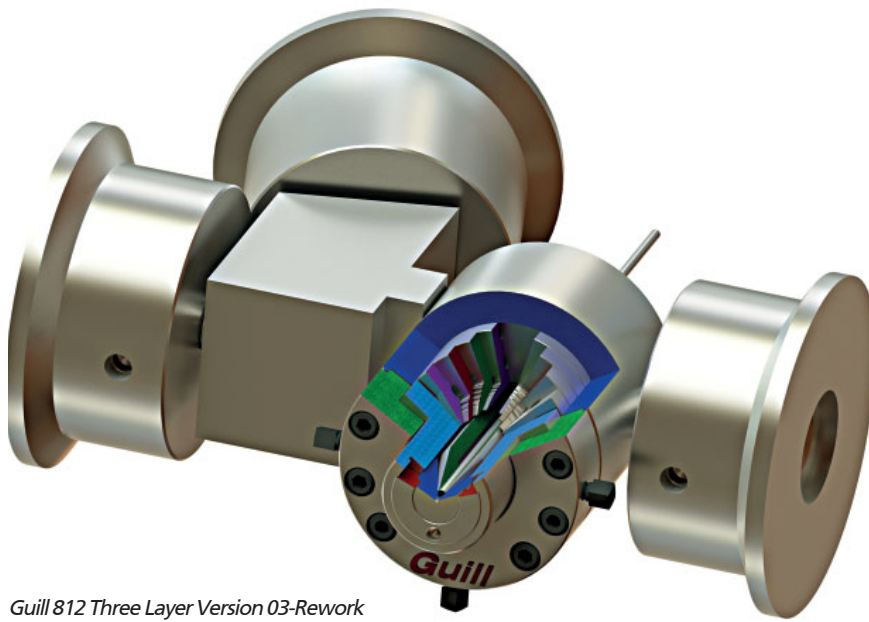

Guill 812 Three Layer Version 03-Rework

true for the sealing and locating surfaces – that control uniformity of the production process. For general maintenance of the tools, before storage or tooling changeover, a thorough cleaning and removal of the excess material assures the precision machining alignments required to produce end products to the precise tolerances. Equipment should be cleaned while it is still hot, since residual polymer and rubber will be easier to remove. Be sure to follow all MSDS recommendations when heating the tooling. Thermal gloves are used to protect the hands from the heated tooling surfaces. A brass scraper, as well as a brass or copper wool cleaning cloth are recommended because they are soft enough not to scratch the surface.

#### Make Tool Cleaning Easier

The quickest way to remove the die is to employ the pressure of the extruder to push it out. Clean the body by using an air compressor and brass pliers so that the material cools down which increases the melt strength, making it into one lump versus an elastic, gummy-like substance that is harder to remove. Cleaning the body feed port using compressed air and brass pliers to simultaneously cool and remove the excess residue from the feed ports. This procedure is followed by brushing with a round brass brush that

polishes the surface. The flow area of the 2" (51 mm) flange adapter should be cleaned by carefully using a brass brush.

Examine all surfaces for any irregularities such as burrs and scratches since these must be repaired before the head is reassembled. Most manufacturers recommend using a hand polishing stone to remove the offending burr. Follow stoning with a light application of 600-grit emery cloth if necessary, but avoid rounding edges that are intended to be sharp. Flat sealing surfaces can also be cleaned using a stone, followed by a 600-grit emery cloth. Place the cloth on a clean, flat surface, preferably a surface plate, then apply friction in a circular hand motion until the area is clean and even. The parts in question should all be hardened steel alloys and will not be adversely affected using these methods. Inconel, monel and Hastalloy® are typically not heat-treated, requiring special care and handling to avoid any damage.

#### Don't Overlook Repairs

Tooling maintenance helps ensure a quality extruded product – one that meets dimensional specifications, maintains the specified minimum tolerance and is economically produced. Dirty, neglected and improperly adjusted tools contribute to excessive compound applications, which in turn complicate

maintenance of minimum thickness tolerance. Excess material results in unnecessary costs and these directly affect the profitability of your company and the relationships with your customers.

#### The Important Final Step – Reassembly

Working from your dedicated tool cart, follow the manufacturer's instructions for reassembly. Give each component a final wipe down with a clean rag before installing. Even the smallest amount of grit, dirt and residual material must always be removed. Use mechanical or manual assistance for heavy and awkward components to avoid unnecessary mishaps. Reapply anti seize compound to all fasteners if required. Tighten fasteners to manufacturer's recommended specifications as well as in the recommended sequence. This fastening sequence should be specified in the manual and is generally in a star pattern. Tighten gradually until the proper torque is achieved to prevent distortion of the tooling. One of a die manufacturer's main goals is to form a concentric cone as quickly and accurately as possible in the primary section of the die – when the extrudate first emerges from the die's distribution capillaries. A properly designed and manufactured die has even distribution close to the extrudate entrance point, but this effort is negated once the die is adjusted, shifting the extrudate off to one side. An eccentric cone is formed in the primary area, and a concentric cone exists at only one point in the process, rather than a smooth, continuous flow path with decreasing volume. A properly manufactured and aligned extruded head, along with well-maintained tooling should require little or no adjustment. Another adverse affect of unnecessary die adjustment is the stress introduced to the extrudate caused by unbalanced flow. The net effect is the final product retains memory of this imbalance and unpredictable die swell occurs.

# SMART EXTRUSION

The only website collecting information about smart technologies of extrusion

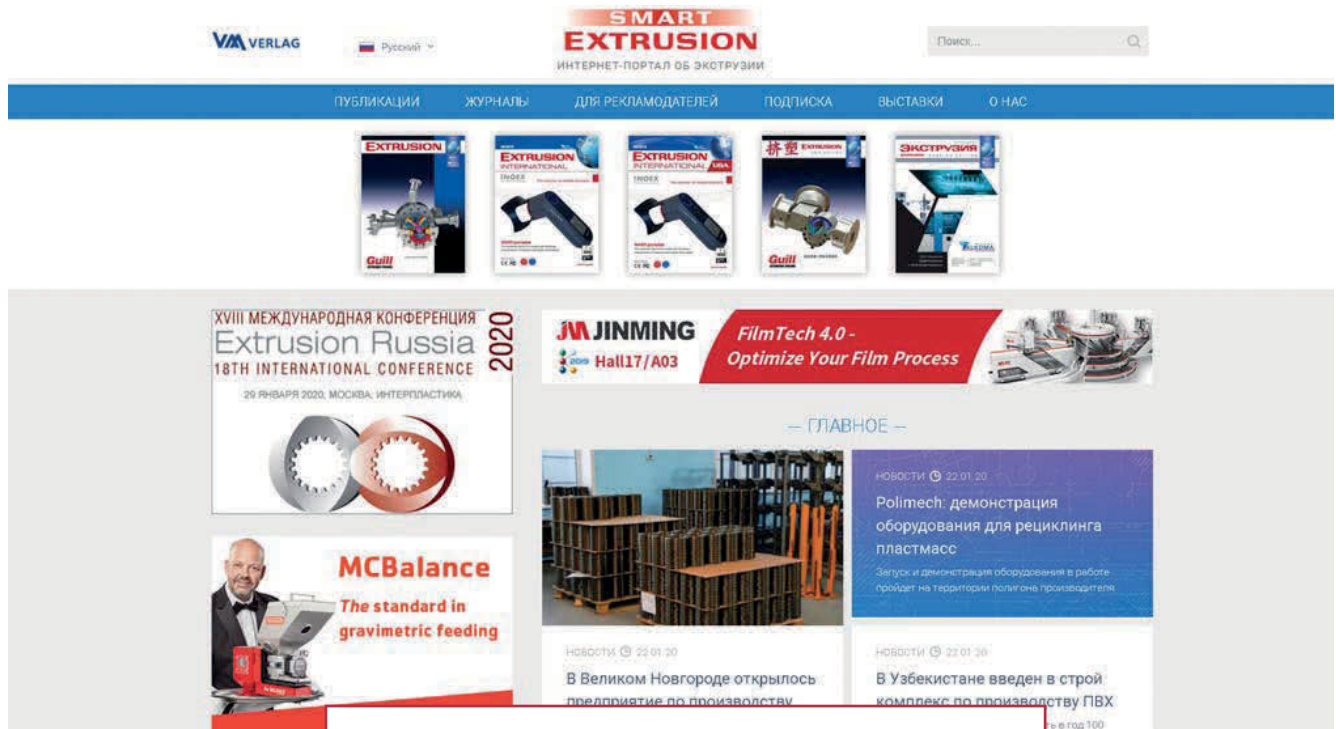

## A SPECIALIZED WEB PORTAL

- ▶ News about relevant products and events
- ▶ Detailed reviews of various smart technologies
- ▶ Case studies from processors
- ▶ English, German, Russian and Chinese
- ▶ Video clips demonstrating smart equipment in live action
- ▶ Latest magazines available for reading and downloading
- ▶ Weekly e-mail newsletters

**34 600 + average monthly visits**

Geographic distribution of Smart\_Extrusion readers, %

- Germany
- Austria and Switzerland
- Italy
- Eastern Europe
- Benelux countries
- Scandinavia

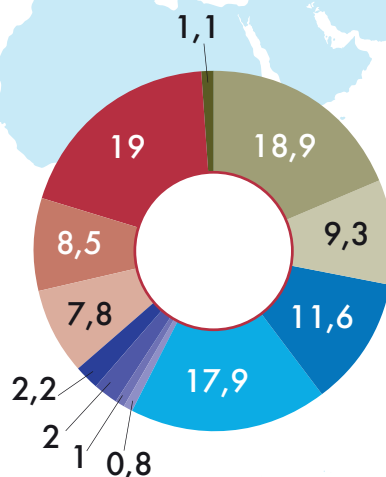

- Other
- Asia
- Russia
- South America
- North America
- Other Europe

[www.smart-extrusion.com](http://www.smart-extrusion.com)

*The two coextrusion solutions supplied by battenfeld-cincinnati in 2019 proved so perfectly satisfactory to the modern Polish system manufacturer of door and window profiles from the very beginning that they immediately placed repeat orders for several more. With the space-saving piggyback models consisting of main extruders and co-extruders, Decco SA based in Suwalki, north-eastern Poland, extends its production equipment to a total of 20 lines. The Austrian extruder specialist battenfeld-cincinnati is currently installing the last models from this year's major order*



*Coextrusion with twinEX 78-34 as the main extruder, combined with a conEX NG 65 as co-extruder*

## Polish Profile Manufacturer Expands with Space-Saving Extrusion Solution

“We are so pleased with the support and the machine solutions from battenfeld-cincinnati that we have been working continuously with extruders from Vienna right from our startup in 2004 and have kept on buying equipment from them ever since”, says Piotr Domaszewski, Managing Director of the Polish profile manufacturer. “The high-performance level of the extruders and their mature process technology support the production of high-grade, durable profiles for some 350 customers in 30 different countries.” Again and again, Decco is extending its product portfolio with additional modern, innovative profile systems to meet its customers’ specific circumstances and needs in terms of both design and performance. Here, sustainability and recycling are vital aspects. This is precisely why the Polish plastics processor has now decided to acquire coextrusion solutions which enable the production of multi-colored designs and the integration of recycled material in the middle layer. To this end, Decco uses not only its own production scraps, which are collected and shredded, but also bought-in recycled material in the form of PVC regrind.

Especially in situations of limited space on the production floor, the piggyback solution designed by battenfeld-cincinnati provides a space-saving alternative. In all coextrusion solutions recently delivered to Decco, a twinEX 78-34 with an output of up to 290 kg/h functions as the main extruder, combined with a conEX NG 65 as co-extruder. The conical twin screw extruder with up to 250 kg/h output is mounted on top of the parallel extruder, so that floor space is required only for the latter. In addition to saving space, the piggyback configuration offers further

cost advantages through a common control cabinet and easy operation, together with high energy efficiency. The integration of tooling is simple and variable thanks to the flexible frame structure of the co-extruder.

“The space-saving solution was certainly a buying incentive for us. But at least just as important are the energy efficiency and performance of the two extruders, which guarantee economical manufacturing of high-quality profiles”, Piotr Domaszewski comments. So the twinEX parallel twin screw extruder with 34 D processing length produces excellent results especially in PVC processing with high output, thanks to its long processing unit and optimized screw geometry. The Intracool screw cooling system and the Air Power Cooling system inside the barrel provide accurate temperature control and thus high melt and product quality. The latter is also due to the conEX conical twin screw extruder of the new NG generation. Its intelligent process technology concept with an extended preheating zone and optimized screw design ensures high output rates with low shear input. In addition to low machine wear, the well-balanced ratio of mechanical and thermal energy input into the melt enhances the possibilities for processing a great variety of different materials with a single screw configuration.

**battenfeld-cincinnati Austria**  
Laxenburger Str. 246, 1230 Wien, Austria  
[www.battenfeld-cincinnati.com](http://www.battenfeld-cincinnati.com)

**Decco SA**  
[www.decco.eu](http://www.decco.eu)

# Record Output Rates for Heavy-Duty Bag Applications

*Reifenhäuser Blown Film presents a new high-performance cooling system on the market for its "EVO FFS" blown film line. It was specially developed for heavy-duty bag applications and achieves record output rates of more than 600 kg/h. Thanks to high-precision flow-optimized components, the new Ultra Cool 2.0 FFS delivers higher throughput while maintaining optimum film properties*

*The Reifenhäuser Ultra Cool 2.0 FFS cooling system achieves output rates of over 600 kg/h thanks to high-precision, flow-optimized components (Photo: Reifenhäuser)*

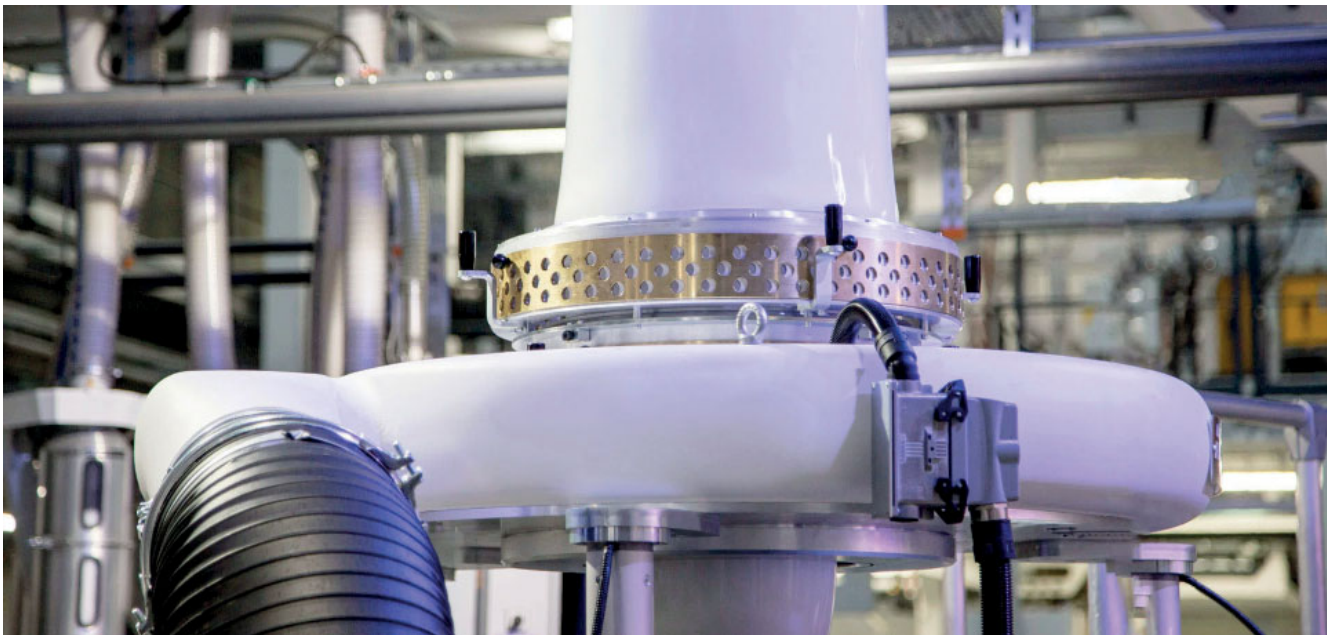

The production of form-fill-seal (FFS) bags for heavy goods is a fiercely competitive market where output rate determines commercial success. At 600 kg/h, Reifenhäuser exceeds customary top values by about 50 to 100 kg, so setting a new benchmark. EVO Ultra Cool 2.0 FFS is suitable for all common formulations and applications (consumer goods, industry, agriculture, etc.), offering at the same time operator friendliness and high line availability. When it comes to mechanical film properties and thickness tolerances, they have achieved the best results in all product tests. This greatly simplifies processes to convert the film on printing and filling machines. Long

service life, easier machine startup and reliable quality also make for high competitiveness and operating comfort. In order to participate in the growing market for sustainable products, the line safely processes recycle and recyclable raw materials.

Eugen Friedel, Sales Director at Reifenhäuser Blown Film, explains: "With our record output exceeding 600 kg/h, we provide our customers with an attractive return on investment and the potential prospect of long-term success on the market. EVO Ultra Cool 2.0 FFS achieves unrivaled performance values without compromising on quality or process reliability."

For its EVO FFS lines, Reifenhäuser offers not only the premium version "EVO ULTRA COOL 2.0 FFS" but also the standard version "EVO COOL FFS". This allows customers to find the perfect solution for every requirement – but in every situation, its performance is above average. All EVO FFS lines are equipped with proven Reifenhäuser EVO extruders and die heads for optimized melt quality at very low melt temperatures.

Reifenhäuser Blown Film GmbH  
Cornelius-Heyl-Str. 49,  
67547 Worms, Germany  
Hertzstr. 12, 53844 Troisdorf, Germany  
<https://reifenhäuser.com/en/lines-components/extrusion-lines/blown-film-lines/>

# High Productivity in Medical Tube Extrusion

*Safe processes and utmost reliability: the medical industry sets strict criteria for the production of medical devices. Medical tubes, in particular, require the highest quality in terms of dimensional accuracy, surface type and complete absence of contamination. The new high-speed extrusion line for PVC medical tubes by Bausano – a leading international player in the design and production of customised extrusion lines for plastics processing – meets the most stringent requirements, such as ISO 14644-1 Class 8 Cleanroom, thanks to the strict design criteria adopted, which also ensure high performance in terms of quantity and energy*

In detail, the high-speed line is capable, even in the most compact configuration, of producing up to 120m of tube per minute. Bausano, indeed, customises each plant based on the Customer's needs, also with regard to the occupied ground volume, through innovative solutions aimed at reducing the size with the same production capacity.

This unprecedented solution is based on a twin-screw extruder from the Nextmover MD 75/24 series, on which a specially designed stainless-steel head is installed. The

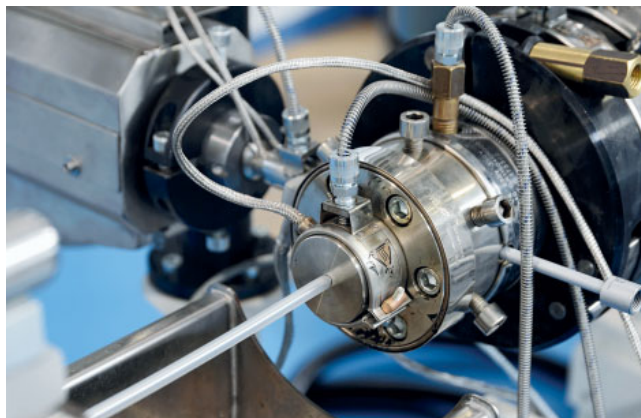

cooling and calibration benches are designed with a idler system to reduce the overall dimensions of the line. In particular, ad-hoc idler systems allow for a threefold increase in the time the tube remains under water, thus ensuring greater efficiency and extrusion speed, with an unrivalled final tube quality.

In this respect, compliance with tolerances, which are particularly tight in the medical sector, is guaranteed by a sophisticated detection system that accurately measures the following parameters: diameter, ovality and wall thickness by laser and ultrasound, cross-section, shape and capacity of the tube, making it possible to rapidly reject non-compliant extrusions.

Another distinctive feature is the Haul-Off Unit, which is equipped with a Control Panel that, when fitted with the detection system, displays speed, measurement data and tolerances on the tube and its alarm systems. Furthermore, brushless motors, on request, help ensure even greater pulling accuracy for complete control of tube tension. Two types of accessories complete the line: the quick cutting system or the automatic winders, whose speed is precisely controlled throughout the winding process.

"The construction of an extrusion line for medical products is always a very challenging project, especially when installing in limited spaces and it is necessary to down-size the plant compared to standard sizes," states Giovanni Bausano, Head of the Technical Department, adding "Thanks to decades of experience, Bausano is able to respond with cutting-edge technological solutions to the most complex technical specifications, in full compliance with strict international standards" and concludes "In this sense, the new high-speed line is an example of excellence, especially in terms of component customisation, including the Industry 4.0 software, which can be configured in the language of the end customer".

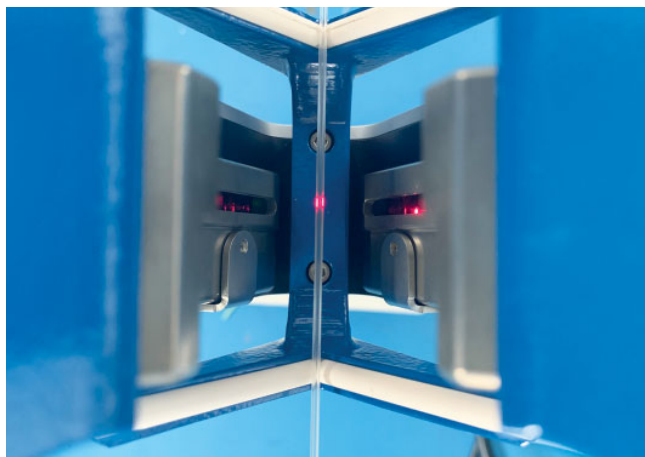
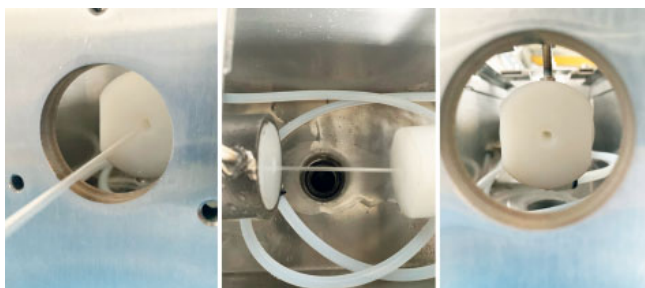





*Thai Polyethylene Co., Ltd. (SCG Chemicals Group Subsidiary, Thailand group company) has taken its resin development to the next level with the installation of a Davis-Standard extrusion coating and laminating line for flexible and aseptic packaging applications. In operation since mid-2021, the new line has enabled the company to demonstrate existing and proven SCG resins for the aseptic packaging and to test new novel SCG resins used for paper and aseptic packaging for liquid packaging, flexible packaging, woven coating and tarpaulin applications*

## Resin Development Taken to the Next Level with Installation of Extrusion Coating and Laminating Line for Flexible and Aseptic Packaging Applications

SCG has already achieved excellent results during extrusion and adhesive lamination trials, including autoclave LDPE resins for high-speed coating and consistent stability during PE and PP film runs with SCG resins. “We chose Davis-Standard because of their expertise in extrusion coating and ability to customize the line to accommodate our specific requirements,” said Niwat Athiwattananont, Technology & Product Development Director, Polyolefins and Vinyl Business of SCG Chemicals, defined the machine speci-

*Niwat Athiwattananont Technology & Product Development Director, Polyolefins and Vinyl Business of SCG Chemicals*



fications and performance thereafter achieved Davis-Standard’s German subsidiary, ER-WE-PA GmbH.

“We were able to combine dry lamination capabilities into one machine for added versatility while maintaining the high-speed coating performance needed for demonstrating resins used in aseptic applications. We can now expedite our R&D efforts and production development by proving resin performance prior to customer trials. This is enabling us to produce attractive options using new structures with reliable accuracy”, Niwat added.

SCG Chemicals, the parent company of Thai Polyethylene, is one of Thailand’s largest integrated petrochemical companies. The company offers products ranging from upstream production of olefins to downstream production of polyethylene and polyvinyl chloride. The installation of the Davis-Standard lab line at their facility in Rayong, Thailand, aligns with the company’s commitment to developing new technology that creates high value-added products (HVA) and service solutions for customers worldwide.

Niwat noted that Covid restrictions and measures made commissioning a challenge. But through a lot of hard work, communication and feedback, Davis-Standard collaborated with them to get it done. “Our teams did an excellent job of working through various Covid-related issues and changes during the process. Davis-Standard’s on-site service teams were professional and experts in their field.”

Davis-Standard offers one of the industry’s largest and most versatile extrusion coating and laminating platforms, including customization based on customer requirements. ER-WE-PA, specializes in technology for aseptic packaging film and worked with Thai Polyethylene on this project.

“The innovation being delivered on this new line is significant for Thai Polyethylene’s customer base,” said Daniel Schiller, area sales and project manager for Davis-Standard.

**Davis-Standard, LLC**  
1 Extrusion Drive, Pawcatuck, CT, USA  
[www.davis-standard.com/](http://www.davis-standard.com/)  
[/converting\\_system/extrusion-coating/](http://www.davis-standard.com/converting_system/extrusion-coating/)

*The Benelux carpet and artificial turf industry has taken a big step toward a greener future with the recent release of an industry road map. In the document the industry sets out ways to significantly reduce energy usage and to aim at 100% recyclability of their products. Meaf Machines has now set up its in-house extruder test and demonstration line specifically to help manufacturers to try out new greener carpet backing materials before committing to a large scale conversion of their production lines*

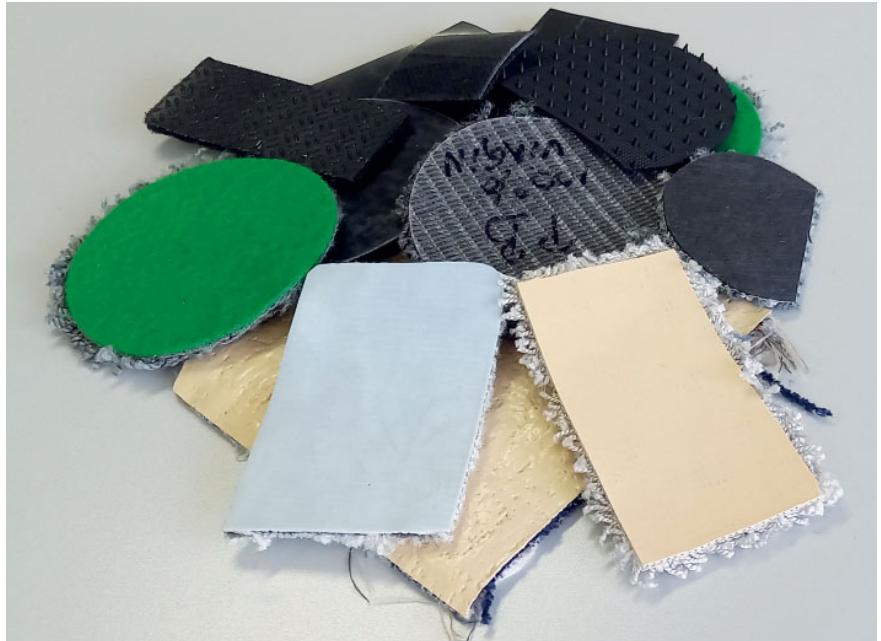

*Meaf Machines has now set up its in-house extruder test and demonstration line specifically to help manufacturers to try out new greener carpet backing materials before committing to a large scale conversion of their production lines (Source: Meaf)*

## In-House Extruder Test Line Added

"The carpet and artificial turf industry is fully aware it needs to reduce its ecological footprint, both in the production as well as at the end of life cycle," says extrusion expert Rony d'Hollander. "Due to the demands placed on carpet backing, such as dimensional stability, moisture and wear resistance, but also ease of laying and cleaning, companies face quite a challenge to go from the traditional, hard to recycle, carpet backing to more sustainable solutions. At present the main materials used are bitumen and latex based products. The latter is a wet process that requires a lot of processing water and natural gas for drying tunnels, and neither can be easily recycled. A possible way out of the conundrum of the industry is to switch to thermoplastic elastomers (TPEs) for carpet backing."

Building on 75 years of machine building expertise, Meaf's extruders are some of the best in class when it comes to flexibility, energy efficiency and installation footprint. "Not only our customers benefit from the modular design of our machines. It also allows us to easily rotate between a set-up for packaging or carpet backing on our test and demonstration line," says Roald de Bruijne, Sales Manager at MEAF. "Our screw and barrel technology can process almost any thermo-

plastic, even when larger quantities of fillers like CaCO<sub>3</sub> or additives are used in order for the material properties to meet the industry's specifications."

Working closely with people from the carpet and artificial turf industry, Meaf modified its test and demonstration line to include new cooling rollers, while the extruder can now be set to produce both primary and secondary backing. "And the beauty is that this technology can also be applied to their existing machines, making it easier for customers to make the switch to sustainable production on their current machinery. When companies are looking for a new type of raw material, material mixture or a new machine supplier, it is always helpful to be able to run a test before deciding the best way forward," adds Roald. "It is like taking a test drive when you are looking to buy a new car. With Meaf's in-house test and demonstration line, we are happy to provide this capability to our customers as well."

Meaf Machines b.v.  
Burenpolder, Industrieweg 10, 4401 LB Yerseke, The Netherlands  
[www.meaf.com](http://www.meaf.com)

# Efficient Quality Control at the End of the CV Line

## *Ningbo Orient uses SIKORA's X-RAY 8700 NXT to ensure accurate cold measuring values in CV lines*

*For a continuous and reliable quality control at the production of medium, high and extra-high voltage cables as well submarine cables in CV lines, SIKORA's X RAY 8000 product family has set standards with more than 1,500 devices sold worldwide. The systems convince by precise and reliable measurements of concentricity, wall thickness, diameter and ovality as well as by controlling cables with up to three layers*

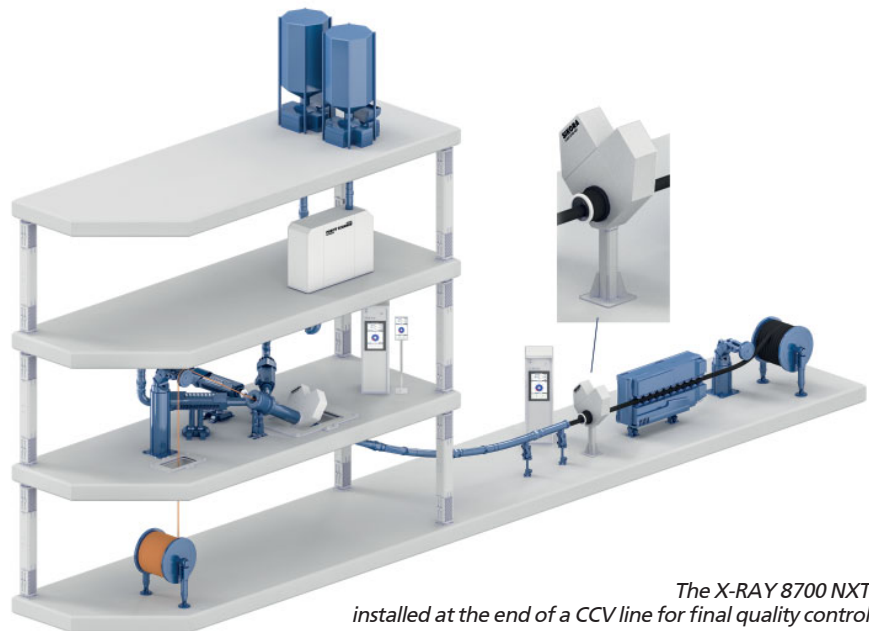

The X-RAY 8700 NXT installed at the end of a CCV line for final quality control

Many submarine cable manufacturers, such as the Chinese company Ningbo Orient, rely on X-ray devices from SIKORA for quality control in CV lines. In addition, producers of power cables benefit from the fi-

nal quality control as it ensures the highest quality of the cables delivered to their customers. While the X-RAY 8000 ADVANCED/NXT provides information for a fast centering of the crosshead and an

automatic control, the X-RAY 8700 NXT measures the final product dimensions (diameter, wall thickness, concentricity) at the end of the production line. It is applicable for cables with solid and stranded as well as Milliken conductors with single, double or triple layer insulation. The X-RAY 8700 NXT is also suitable for quality control of insulation material based on polypropylene (High Performance Thermoplastic Elastomer – HPTE). The combination of the X-RAY 8000 ADVANCED at the beginning with the X-RAY 8700 NXT at the end of the line offers a precise determination of the shrinkage values for all three insulation layers. This assures an optimum process control for a perfect final cable.

*Ningbo Orient uses the X-RAY 8700 NXT from SIKORA in its submarine cable production line for final quality control*



SIKORA AG  
Bruchweide 2, 28307 Bremen, Germany  
[www.sikora.net](http://www.sikora.net)

# Working Together Over Generations

*The Spanish recycling company Anviplas has been involved in plastics recycling for more than 30 years, during which time it has built up extensive know-how that now benefits customers throughout Europe, in Africa and in Asia. Their cooperation with EREMA is almost as long. Since 1991, Anviplas has relied on the technology and service provided by the Austrian recycling machine manufacturer*



*Aleix Vintró, CEO Anviplas, and Joan Vintró at the Navacles plant. An EREMA INTAREMA® 1716 TVEplus® from EREMA is in operation there*

“EREMA machines have delivered excellent results at our company over all these years. Featuring industry-leading technology, these machines are also easy to use, very reliable, and they have always met our expectations. Even on particularly challenging projects,” says Anviplas CEO Aleix Vintró, who took over the business from his father Joan, who founded the company together with Aleix’ grandfather and uncle. He highlights the recycling of barrier film as an example, which consists of three different layers of material.

Employing 64 people, Anviplas recycles post-industrial and post-consumer plastic waste, especially HD and LDPE as well as PP, to make recycled pellets in all colour variations. The production capacity is 1,800 tonnes per month. An EREMA type INTAREMA® 1716 TVEplus® recycling machine with screen changer is in operation at the site in Navacles (Barcelona) for processing the PP material stream. This patented extruder system was developed for handling difficult-to-process materials, such as heavily printed films as well as very moist waste. This machine is characterised by its optimised 3-stage degassing system; firstly by preheating and predrying the material in the preconditioning unit, secondly because the screw design allows reverse degassing, and thirdly in the degassing zone of the extruder. “With TVEplus® technology, this is located after the melt filtration, so that only completely melted, filtered and homogenised material can pass through the degassing zone,” explains Jan Stöger, Sales Organisation Manager at EREMA.

Anviplas customers manufacture a huge bandwidth of products made using their recycled pellets. They range from various film products, such as stretch, shrink, mulch and silage films, to irrigation, corrugated and high-pressure pipes, as well as containers such as tubs, bottles, barrels and crates. All these applications require recycled pellets that meet the highest quality specifications. “That is precisely our strength,” says Aleix Vintró. “We produce the highest possible quality recycle, because we want to continue to offer our customers products that optimally meet their needs and open up business opportunities that are cost effective and environmentally sound.” That is why Anviplas is currently working intensively on improving the recycling process for complex multilayer materials. Once again, EREMA is a reliable partner.

In February 2022 the Repeats Group, a pan-European platform for LDPE recycling, and Anviplas announced, that Repeats has made an investment in the Spanish recycling company. For Repeats this investment in Anviplas represents an important step in building a pan-European plastics recycling platform. Under Repeats’ leadership, the Company plans to nearly double its production capacity to meet the growing demand for recycled LDPE in Europe. Aleix Vintró will continue to lead the Spanish operations and expansion plans going forward.

► EREMA Engineering Recycling Maschinen und Anlagen GmbH  
Unterfeldstr. 3, 4052 Ansfelden, Austria  
[www.erema.com](http://www.erema.com)

**300+**  
participants

Azimut hotel  
43/1, Lermontovsky prospect  
Saint-Petersburg  
Russia

May  
**17-18,**  
2022



**IPTF**



**10**

anniversary  
International Polymer  
Technology Forum

**W**orking in polymer  
company?

**THIS FORUM IS FOR YOU!**

⚙️ We look forward to meeting you at  
Fontanka River Near the Egyptian Bridge

- ▶ Extrusion
- ▶ Injection molding
- ▶ Laboratory
- ▶ Recycling
- ▶ Polymers and additives
- ▶ Films
- ▶ Profiles
- ▶ Pipes and tubes
- ▶ Smart warehousing
- ▶ Automation and peripherals



omprehensive review of all the issues,  
vital for plastics processors

Contact

Alla Kravets

+49 2233 949 87 93

a.kravets@vm-verlag.com

Organized by

**VM** VERLAG GmbH

**EXTRUSION**

**ПЛАСТМАС**  
МЕЖДУНАРОДНОЕ ОБЩЕСТВО ПРОЦЕССОРОВ



Learn more at

[iptf.extrusion-info.com](http://iptf.extrusion-info.com)



# MENA PET Recycling Giant Signs Contract for New Recycling System

*Andreas Pechhacker, General Manager Starlinger recycling technology, Mostafa Khairat, CEO BariQ, and Tasos Bereketidis, Sales Director Emerging Markets at TOMRA Sorting Recycling, signed the contracts for the plant expansion (©BariQ)*



*Based in Giza, Egypt, the biggest PET bottle-to-bottle recycler in MENA region is expanding and upgrading its existing plant with another Starlinger PET recycling system and an additional solid-state-polycondensation (SSP) reactor*

The new recycling system, a recoSTAR PET 215 HC iV+ including a viscoSTAR 350 SSP reactor, reaches an output of 2700 kg/h and will enable BariQ to increase its total production capacity to 35,000 metric tonnes of food-grade rPET pellets per year. The viscoSTAR 350 SSP reactor – the biggest size of the latest reactor generation – provides extended processing capacity and residence time while it keeps the footprint of the new recycling line compact like the first Starlinger PET recycling line BariQ installed in 2012.

BariQ will also upgrade its existing Starlinger recoSTAR PET 165 iV+ recycling line with a new melt filter for fine filtration and an additional SSP reactor. This setup not only increases

the line's output, it also allows the production of rPET types beyond the regular bottle-to-bottle grades, guaranteeing best decontamination results and 24/7 production of rPET with highest quality specifications. BariQ's investment also includes the latest sorting equipment from TOMRA Recycling to ensure optimum quality of the input material. The new facility will complement a recycling plant that has been fully operational since 2010 and features 4 of TOMRA's sensor-based sorting systems that process more than 3 tons of PET bottles per hour. To date, the company produces an annual amount of 15,000 tons of food-grade rPET that is compliant with the standards set by EFSA, FDA, Health Canada and REACH.

The contracts for the new equipment were signed during a ceremony held on February 13, 2022, at the BariQ plant. Members of the management of INTRO, the parent company that acquired BariQ in 2021, and BariQ explained details of the company's sustainability strategy and drivers for the plant expansion in presentations during the event. The expansion is planned to be finalized in 2023.

According to BariQ, the high variability of the input material and the rising quality requirements of the customers are the biggest challenges the company has been facing since it started operations in 2012. BariQ sources its post-consumer bottles mainly from local collection and GCC countries. As bottle quality and decontamination vary greatly, the recycling equipment must be able to handle such demanding conditions in order to achieve top rPET quality and meet customer requirements.

"Starlinger has been there for BariQ from the start. We counted on the on-site and remote support from Starlinger, and they even exceeded our expectations. During the past decade, Starlinger has supported us with their reliable equipment and technology, meeting the highest quality specifications and rising quality requirements of the customers, and handling the entire variability of raw materials. As for the new line, the technical discussions with Starlinger started two years ago, ensuring that the line is equipped with the latest technology and meets all standards to achieve top quality in rPET resin production. Believing in the decontamination efficiency of Starlinger technology and their excellent customer support, BariQ again choose Starlinger for the expansion project", said Ahmed ElKasaby, Chief Operations Officer at BariQ.

"When BariQ took up operation in 2012, they were our first customer for PET recycling in Africa", explained Andreas Pechhacker, General Manager Starlinger recycling



TOMRA New generation AUTOSORT

technology. "The planning for the plant had started already two years before – our bottle-to-bottle recycling experts worked closely with BariQ to customize the machine design during this time, taking into account the local bottle stream and requirements for food contact rPET. During the past decade we have built up a very close partnership. BariQ was able to turn their

vision into reality – their ambition to set standards was rewarded with several certificates and the acquisition of customers all over the globe. Starlinger is proud to support BariQ on their way to become the biggest PET bottle-to-bottle recycling company in the MEA region."

Founded in 2011, BariQ is the first food-grade rPET producer in Egypt and the biggest in the MENA region. The company started production of food-grade rPET with a Starlinger PET recycling line in 2012 and holds a positive EFSA opinion and an FDA Letter of Non-Objection (LNO). It is also the first non-European recycling company to be registered with ECOEMBES Spain. In November 2021 BariQ was acquired by INTRO Resource Recovery, a member of INTRO Group, to strengthen its waste management portfolio. With the upcoming facility expansion, BariQ aims to recycle 3.5 million PET bottles per year, producing 35,000 tonnes of food-grade rPET for new bottles and saving 80,000 tonnes of CO<sub>2</sub>. BariQ supplies the food-grade rPET to major converters and brand-owners in Europe and worldwide.

Polymer flakes



▶ Starlinger recycling technology  
[www.recycling.starlinger.com](http://www.recycling.starlinger.com)

TOMRA Sorting GmbH  
[www.tomra.com/recycling](http://www.tomra.com/recycling)

BariQ  
[www.bariq-eg.com](http://www.bariq-eg.com)

*SuperBon employee next to WEIMA WSM cutting mill*



# Super Recycling in Romania

*Countless companies are facing major financial tasks in the wake of the Covid-19 crisis. This also applies to SuperBon, a recycling company in north-western Romania – albeit an optimistic one. Sales there have increased by almost 100% compared to 2020. And an end to this trend is not yet in sight. The consistently high demand from the injection molding industry is the main factor driving this sustainable trend and the industry's appetite for recyclates currently seems to know no limits. The rapidly rising oil prices are doing the rest. The production of new plastics is as expensive as it has been for a long time. Since 2015, SuperBon has been using WEIMA shredders and granulators as their reliable partner for its size reduction. Production has now been expanded again*

Since the company was founded in 2006, SuperBon has two sites where it specializes in the collection and recycling of waste which primarily includes plastics, but

*Yellow regranulate from SuperBon*



also cardboard, paper, wood, metal, electronic waste (WEEE) and textiles. In Oradea, a city close to the border with Hungary, high-quality regranulate made from engineering plastics such as PS, ABS or PC is manufactured on a production area of 1,300 m<sup>2</sup>. This precious raw material is then sold in Romania, but also in large parts of Europe. Due to the high demand, SuperBon has even been exporting its products to China for some time now.

## **SuperBon on expansion course – with EU funding**

In the majority of recycling processes, the shredding, i.e. granulation of waste material plays a central role in its processing and the subsequent quality of the regranulate. This is the reason why in 2015 SuperBon decided to use rugged WEIMA granulation technology from Germany. Today, the Romanian recycling company is the proud owner of three machines, one pre-shredder (WLK 1000) and two secondary shredders (WSM 450/600 cutting mill, WNZ 200/600 granulator). The project was financed using funding from the European Union. When



applying for EU funds, WEIMA was on hand to provide expert advice as a partner. SuperBon Commercial Manager, Ançuã Magda, comments: "In the near future, we will try and use more funding to invest in high-quality equipment. We want to become even more productive."

To achieve the ambitious output targets on a day-to-day basis, the universal WEIMA WLK 1000 single-shaft shredder with a working width of 1,000 mm and a rotor diameter of 370 mm is the ideal machine. With the help of a powerful and low-maintenance electromechanical drive, plastics, as well as wood waste, paper and light alloys, can be shredded to a uniform grain size.

**Meeting demands for high output and service**

The recently commissioned WEIMA WSM 450/600 cutting mill has a drive output of 45 kW. It granulates pipes and plastics from the automotive industry, PET bottles, containers, films and fibers as well as granulated plastics to a grain size of 3 to 12 mm. The machine, just like the WNZ granulator, is characterized by low energy and maintenance costs. The noise level is reduced to a minimum due to the machines' design. This is not the only reason why Magda draws a positive conclusion:

"We used to mainly purchase second-hand equipment from other manufacturers. The output we can now achieve with WEIMA shredders significantly reduces our production costs. The quality of the machines is what convinced us. As well as the service. The ordering of wear parts is a particularly customer-friendly procedure."



WEIMA WSM cutting mill with air extraction and big bags for regranulate collection

WEIMA Maschinenbau GmbH  
 Bustadt 6-10, 74360 Ilsfeld, Germany  
[www.weima.com](http://www.weima.com)

# SMART EXTRUSION

The only website collecting information about smart technologies of extrusion

**34 600 + average monthly visits**

Geographic distribution of Smart\_Extrusion readers, %

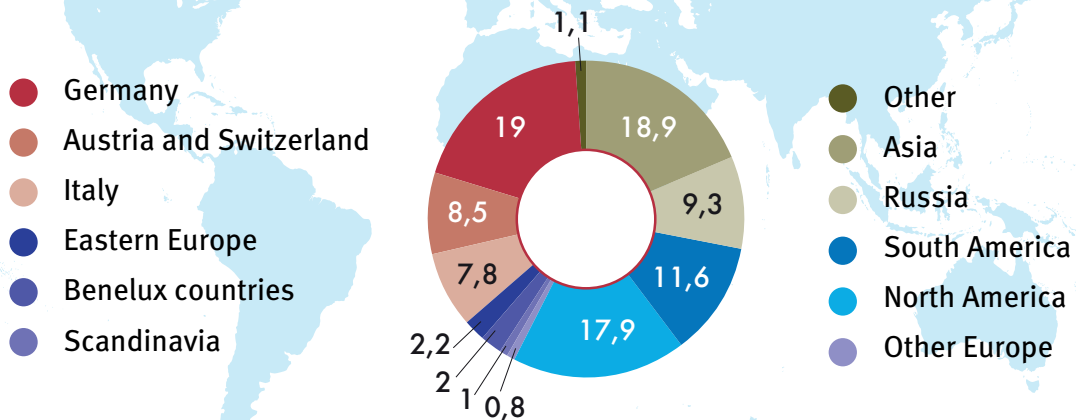

# Hygienic Shields Become High-Quality Recycling Resources

*Krall provides disposers and collecting points with a comfortable possibility to return used hygienic shields for infection protection (also known as sneeze guards), as well as corresponding production residues to a sustainable, environmentally friendly reuse saving both resources and costs (© iStock.com/miodrag ignjatovic)*



*A great number of hygienic shields, commonly known as sneeze guards, is being used in industrial and trade facilities, as well as in the catering trade and restaurant business. Now the disposal of these highly transparent plates, which may consist of very different plastic material, is becoming an issue. Krall Kunststoff-Recycling has foresightedly prepared for a sustainable recycling. With a powerful infrastructure and state-of-the-art technology, today the company is able to accept random quantities and turn them into single origin regrinds that are highly demanded in the plastic industry. For waste disposal companies and collecting points, this is an environmentally friendly and financially attractive alternative to the thermal utilisation of these mixed plastic scraps*

## Reuse instead of Incineration

Executive director Markus Krall explains: "The sneeze guard – omnipresent due to the pandemic – presently is still a rather dormant resource for plastic recycling. We expect an increasing amount of them to incur at the recycling centres and at the classical disposal companies acting as local collection points for rubbish and industrial waste. The different, but visually very similar plastic types cannot be distinguished there, so that the plates mostly are unsorted and then have to be disposed of as residual waste with costs. By contrast, there is our offer to accept these collected goods and to return them into the raw materials cycle. We accept all common box systems up to large containers, and beyond that even offer the possibility to unload walking-floor trucks."

As the mechanical recycling is only possible with identical plastics, Krall

then performs the task firstly to sort the materials separately according to fractions and only then to grind them. "With this step, the regrind becomes attractive for reuse, as only then it can be used for the production of high-quality plastic products again, be it injection of moulded parts or extrusion of plates and profiles", says Krall.

## With Future-oriented Technology to Sorting Purity

The heterogeneity of the collected goods is due to the discrepancy between the sudden high demand for corresponding plates and the limited supply of raw materials respectively available at short term. Krall continues: "As we traditionally also dispose of the production residues of producers and processors, we know quite exactly what to expect. This will mainly be – up to about 70 % – polymethyl methacry-

late (PMMA), followed by about 10 % polycarbonate (PC) as well as small amounts of PET-A and PET-G, styrene-based thermoplastics like PS, SAN, or ASA, and PVC, too.

To guarantee that the finished regrind will be actually single-origin despite these unfavourable conditions, Krall made a future-oriented investment. The company is just starting up a new system especially configured for its demands to safely distinguish and separate even very similar plastic materials. This enables the recycler to offer regrinds with nearly virgin material processing quality. This exceeds by far the common sorting by colours, which the company keeps on doing as a standard feature and also offers as a service.

► Krall Kunststoff-Recycling GmbH  
Glanzstoffstr. 21,  
63820 Elsenfeld am Main, Germany  
<https://kunststoff-recycling.de>

# Pump & Filtration Systems, Pelletizing & Pulverizing Systems, Recycling Systems and Digital Solutions at Greenplast 2022

*At Greenplast in Milan, Italy, from May 3-6, 2022, MAAG Group shows integrated solutions for the processing of polymers in the recycling process in hall 14, booth 31, in particular the ERF high-performance melt filters from ETTLINGER*

MAAG ETTLINGERs ERF 350 is a high performance melt filter for the filtration of heavily contaminated polymer feedstock. The filter is self-cleaning with a rotating, perforated drum, through which there is a continuous flow of melt from the outside to the inside. A scraper removes the contaminants that are held back on the surface and feeds them to the discharge system. This enables the filter to be used fully automatically and without any disruptions over long periods without having to replace the screen. The advantages: Reliable melt filtration, ultra-low melt losses and good mixing and homogenizing of the melts.

PEARLO® 350 EAC with liquid-heated die plate for high capacities:

The underwater pelletizing system PEARLO® 350 EAC is especially designed for high throughputs of like 18.000 kg/h of Virgin Polymer production. The unique cutting blade design and optimum water and material flow conditions within the cutting chamber provide not only ideal and homogeneous cooling effects but also outstanding pellet quality. Another innovative design feature of the PEARLO is the cutting blade advance system, which permits axial movement of the cutter shaft resulting in a precise blade advance as well as a regrinding of



*MAAG Ettlinger's ERF 350 high performance melt filter*

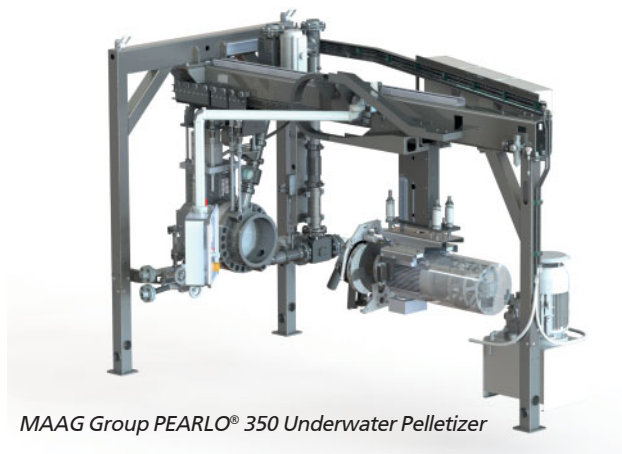

*MAAG Group PEARLO® 350 Underwater Pelletizer*

the blades during production. This allows higher equipment availability, elongated production runs and thus saves costs.

Innovation in strand pelletizing: The PRIMO Plus Flex provides

- Shortest unguided length in combination with an enlarged rotor diameter lead to more torque on one hand and to superior pellet quality on the other
- Throughputs up to 5,000 kg/h
- Profitable production due to very high machine availability with wear resistant cutting tools

For applications such as pelletizing of base polymers, recycling products, processing of highly filled compounds or ETPs at different pellet lengths from micro to LGF, the PRIMO Plus is our first choice for a reliable dry cut strand pelletizing process.

All MAAG Group extrex® gear pumps in x6 class design are completely re-engineered and have redesigned components, from the shafts through to the bearings and seals, and optimized the interaction of the components. Specially developed gear teeth with low compression allow very high pressures to be achieved with low shear rates. The result is a further increase in achievable product quality, volumetric efficiency, as well as production consistency and safety.

Claudio Bonafede, General Manager: "Another innovation in the market is the MAAG Brain. We are happy to present this stand-alone monitoring system, which is a step forward in the world of Industry 4.0 and Internet of Things (IoT). The system has been developed to monitor pumps and ensure their maximum efficiency during the operation."

# Sustainable Composite Decking



*Plastic waste before shredding*

*For decades, plastic and paper waste has been sent overseas to be recycled. Domestic recycling is often more efficient, environmentally friendly, and cost-effective. Repurposing plastic waste where it's created can provide a new income stream for businesses while eliminating the need to ship waste materials across the ocean. Fiberon has embraced this process, proving that being attentive to the environment does not always have to be a financial burden*

Recycling in the United States goes beyond placing plastic beverage bottles in a curbside collection bin. Post-consumer recycling is crucial in providing sorted waste streams for reclaim, but that's not where the process ends. Companies that seek to manufacture new products from recycled contents can source reusable materials from collection centers where these materials are sorted by type – if there is enough recycled material available. Manufacturing scrap – waste created during manufacturing – can supplement post-consumer material streams. In-plant size reduction machinery makes it possible for companies to reclaim manufacturing scrap by sorting it, shredding it, and reintegrating it into new products. This is the circular economy in action.



*Fiberon regranulate from PE plastic waste*

**Post-industrial waste as a resource**  
 Significant amounts of post-industrial waste end up in landfills for a

variety of reasons. Companies often are unaware that recycling and re-integrating their waste materials is possible. For this reason, these valuable materials are frequently discarded instead of being repurposed or recycled.

Thinking circularly, rather than in a linear way, allows companies to re-imagine what can be produced from these “single-use” scrap materials that would typically go to a landfill. Forward-thinking companies have an opportunity to take the scrap that would traditionally be hauled away and make it into something new, thus creating a new revenue stream.

Having the tools to create that second life for that scrap makes it easier to create a product that gives and gives, rather than taking from the environment. It's about thinking creatively and putting the infrastructure in place to reclaim this scrap.

Madison Burt, CEO of WEIMA America, Inc.: “As a country, we’ve had to shift our focus and bring recycling initiatives and infrastructure into our daily practices, and that includes into our manufacturing processes.”

**Recycling initiatives at Fiberon**

Fiberon, based out of New London, North Carolina, manufactures top-of-the-line composite decking. They do this by sourcing secondary polypropylene scrap – which is strong and easy to use and reuse – from various companies and combining it

*WEIMA S7.30 lift-up shredder with hydraulic drive from Hägglunds*



*Five WEIMA single-shaft shredders shred plastic waste of all kinds*





*Fiberon's decking boards are available in many colours and designs*

with a proprietary (recycled or post-industrial) wood fiber blend. The decking created is beautiful and will last for decades.

Mike Huskey, VP of Operations for Fiberon Decking: "Fiberon uses recycled materials to make its products. We mix together recycled wood and recycled polymers and create a product that will last a lifetime. Our manufacturing processes require large amounts of water, but

by utilizing a closed loop system we are able to recycle the vast majority of water used in our system on a daily basis. It's not only about cost, but it's also about being a good steward of the environment."

#### **Environmental and economic benefits**

The composite decking that Fiberon produces from recycled materials provides a substantial environmental benefit to the company while

creating a new income stream. Fiberon is a tangible example of what it means to recycle production scrap on the spot. They chose WEIMA as a recycling partner to provide size reduction equipment within their New London plant. This machinery breaks down the reclaimed material streams they have sourced to be used in various ways. WEIMA shredders are at the beginning of Fiberon's process – the shredder takes the material and prepares it for conversion into something useful.

Audrey Brewer, North American Marketing Manager, WEIMA America, Inc.: "Being environmentally responsible is something that most corporations really strive for, and I think there's a misconception that recycling initiatives within a corporation have to be an up-front expense, and that's just not the case. You can make incredible ROI from the scrap that would have otherwise been thrown away, and Fiberon is proof of that."

*Fiberon WPC composite decking boards*



WEIMA Maschinenbau GmbH  
Bustadt 6-10, 74360 Ilsfeld, Germany  
[www.weima.com](http://www.weima.com)

*Plastic pipes for protecting cables in the ground are available in a wide variety of diameters and wall thicknesses. One thing is the same in all cases: the cables inside the pipe are to be protected from environmental influences and damage. To ensure this, appropriate standards must be met that clearly specify the properties of the conduit. Among other things, these standards specify the diameter/wall thickness ratio, which fixes the amount of material per running meter of pipe. To save costs, recyclates or B-goods are often used, whose property profile and processing characteristics are highly dependent on the batch*

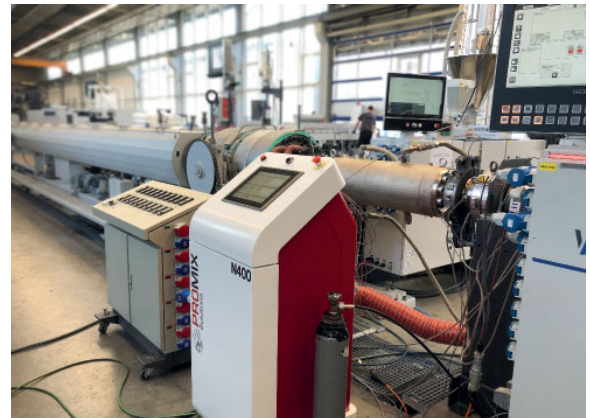

Weber pipe extrusion line equipped with Promix physical foaming system

## CO<sub>2</sub> Reduction and Cost Savings Through Physically Foamed Cable Protection Tubes

### Saving costs by using environmentally friendly gases

Another approach to reducing costs and plastic consumption is to physically foam the pipes. Here, environmentally friendly gases such as carbon dioxide or nitrogen are injected into the plastic and mixed with it in the extruder. In the subsequent pipe extrusion process, these gases form a fine-pored foam that leads to weight reduction and thus to savings in plastic.

### Joint venture – working together for the best result

In a joint project of the companies Hans Weber Maschinenfabrik and Promix Solutions, the feasibility, practicality and savings potential have now been determined. For this purpose, WEBER provided a grooved barrel extruder type NE7.40 for the foamed middle layer and a grooved barrel extruder type NE5.40 for the inner and outer layers. A WEBER PKM250 3-layer pipe head was used as the die. In addition, the downstream equipment available in the technical center of Hans Weber GmbH: Cooling section, haul-off and saw were used. Promix Solutions provided an N400 gas dosing station with adapted injector for precise metering of the nitrogen and a P1 180 melt cooler for homogenization and

temperature reduction of the melt. In the initial trials, Borealis' HDPE HE3490 LS was used for a DN110 x 6.3 cable protection tube and foamed with nitrogen.

After production of a non-foamed reference sample, the metered gas quantity was gradually increased, resulting in a weight reduction of up to 26 % for virgin material and approx. 15 % for recycled material – based on the entire pipe. The pipe produced in this way was subsequently tested in accordance with DIN 16876 and GA KSR 2010 (Switzerland) and was able to meet all requirements. Particular attention was paid to the ring stiffness and the drop test according to DIN EN 744. Based on these positive results, the test was repeated with a foamed inner layer made of recycled HDPE. This also showed good feasibility with a stable process.

### More sustainability through physically foamed cable conduits

In view of the current supply situation for polymers and the ever increasing material prices, microcellular foaming of plastic pipes is a perfect way to save material and reduce the CO<sub>2</sub> footprint for the pipes. In contrast to foaming with exothermic chemical blowing agents, no SVHC (substances of very high concern) listed additives are used and an accumulation of additives via regrind recycling is also avoided. Of course, this technology can also be used for other pipe systems.

In the coming months, the joint tests of WEBER and Promix will be continued to foam further pipe variants, throughputs, and other polymers with this technology. Furthermore, they are working together on a solution for physically foamed PVC extrudates.

*Foamed cable protection tube is using 15 to 26 % less raw material compared to conventional products. This saves costs and adds to more sustainability*



# Focus on the Medical Market Expanded

*US Extruders announced two new exciting updates at the MD&M show in Anaheim, CA, April 12-14. With a continued focus on improving medical extruder technology to better meet the needs of the medical device market, the company presented the latest update to their MED-EX Modern Medical Extruder line at the show. As the technology leader in medical extruders, the latest improvements are ideal for contract manufacturers that are operating in a high-mix, low-volume business as well as scaled, high-volume production*

One major key feature is the direct drive technology for precise speed control and quiet operation. There is no gearbox or belt drive, which eliminates gear oil and airborne dust particles from belts, which is especially important when extruding in a controlled manufacturing environment. To meet the increasingly stringent quality requirements within the MedTech extrusion, US Extruders has developed virtual pressure measurement. Virtual pressure measurement eliminates transducer and rupture disc ports in the barrel and reduces stagnation points where material can degrade. Degraded material that ends up in medical tubing causes a weak point in the final device. This is especially important for applications that demand superior quality beyond dimensional requirements where

maintaining mechanical properties is paramount. Examples include balloon tubing, heat shrink tubing and polymer stent tubing.

US Extruders has developed a custom "universal" barrier/mixing screw specifically designed for Nylon 12, PEBA and TPU reflow compounds that are commonly used for multi-durometer catheter jacketing applications. This screw design, combined with either pressure control or a melt pump, allows for optimal melt temperature uniformity and pressure stability better than 1%.

The company also announced the appointment of Steve Maxson as their new Innovation and Business Development Manager with a focus on developing extrusion solutions needed to support next generation medical technologies. Steve's re-



*The MED-EX Modern Medical Extruder offer improvements that are ideal for medical contract manufacturers that are operating in a high-mix, low-volume business as well as scaled, high-volume production*

sponsibilities will encompass implementing sales, marketing and product development programs.

Maxson joins the company bringing more than 20 years' experience in medical extrusion, catheter manufacturing, and sales and marketing. He most recently served as the VP of Sales and Marketing at Custom Profile, a developer and manufacturer of specialty thermoplastic profile extrusions and sub-assemblies.

"We are all thrilled to have Steve on our team. He brings a wealth of experience and knowledge to our team and we are looking forward to him driving our medical extrusion sales and marketing efforts to new heights," said Dan Schilke, CEO.



*Steve Maxson, Innovation and Business Development Manager*

US Extruders, Inc.  
87 Tom Harvey Road, Westerly,  
RI 02891, USA  
[www.us-extruders.com](http://www.us-extruders.com)



# EXTRUSION

EXPERT MAGAZINE ON PLASTICS EXTRUSION

The only technical magazine worldwide exclusively for the sectors:

- Material Preparation
- Compounding
- Extrusion
- Recycling
- Calendering
- Thermoforming
- Welding
- Finishing of Plastics and Elastomers



**Extrusion** (German)

**Extrusion International** (English)

**Extrusion International USA** (English)

**Extrusion Russia Edition** (Russian)

**Extrusion Asia Edition** (Mandarin/English)

The only plastics trade magazine for Asia, published from Germany

8 issues a year

6 issues a year

6 issues a year

4 issues a year

2 issues a year

**SMART  
EXTRUSION**

All editions available for free:

[www.smart-extrusion.com](http://www.smart-extrusion.com)

**VVA** Verlag GmbH Cologne/Germany



# SMART EXTRUSION

**THE SPECIALIZED WEBPORTAL  
ON EXTRUSION  
FOR EVERY MODERN NEED**



**VM** Verlag GmbH  
Cologne, Germany



[www.smart-extrusion.com](http://www.smart-extrusion.com)