

# 挤塑

# EXTRUSION

ASIA EDITION

G 31239



2/2022

**VM** VERLAG  
Cologne/Germany

# Guill

WORLD LEADER IN EXTRUSION TOOLING

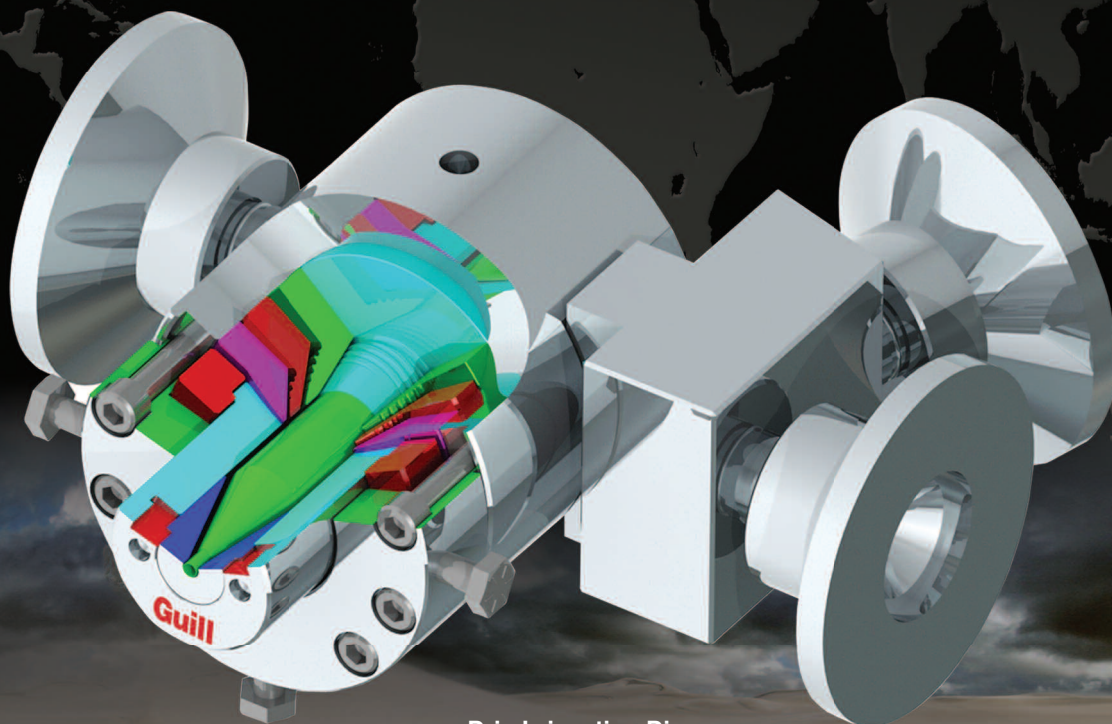

Drip Irrigation Die

[www.guill.com](http://www.guill.com)

# SMART EXTRUSION

The only website collecting information about smart technologies of extrusion

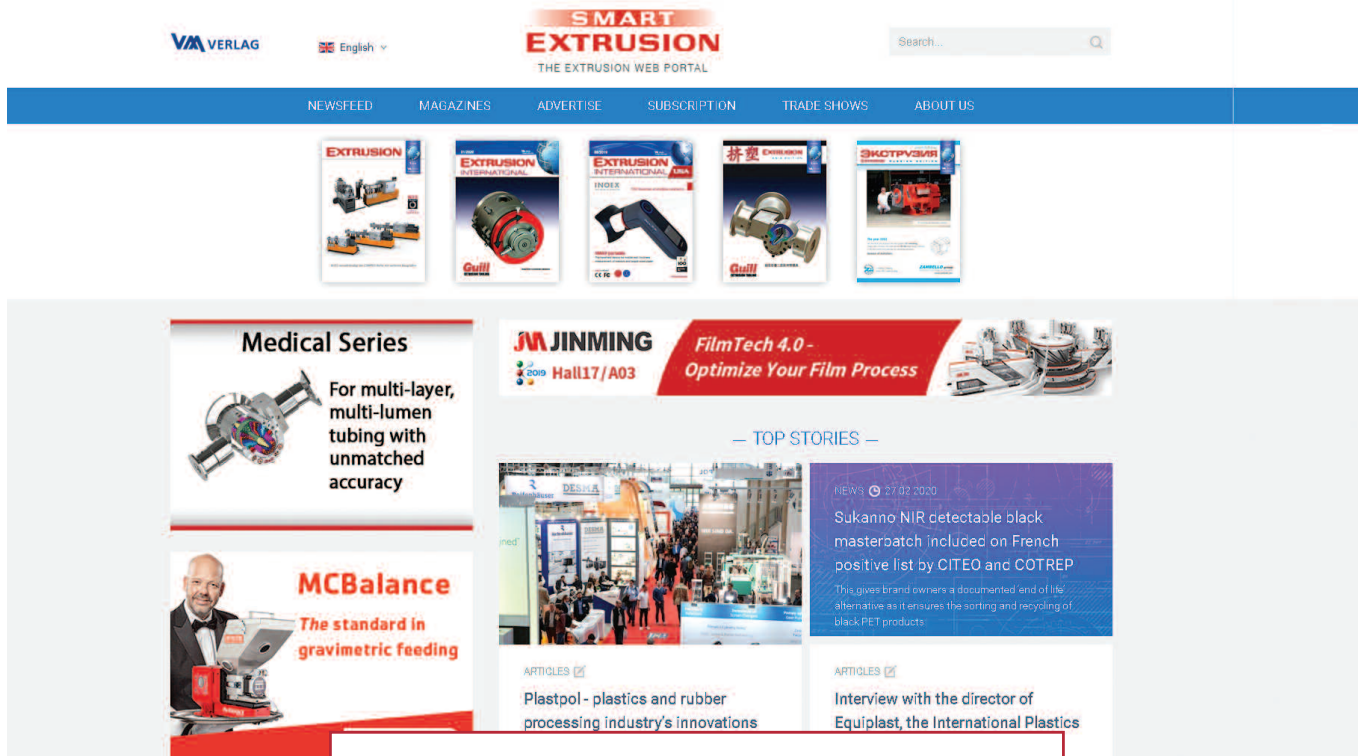

## A SPECIALIZED WEB PORTAL

- ▶ News about relevant products and events
- ▶ Detailed reviews of various smart technologies
- ▶ Case studies from processors
- ▶ English, German, Russian and Chinese
- ▶ Video clips demonstrating smart equipment in live action
- ▶ Latest magazines available for reading and downloading
- ▶ Weekly e-mail newsletters

**34 600 + average monthly visits**

Geographic distribution of Smart\_Extrusion readers, %

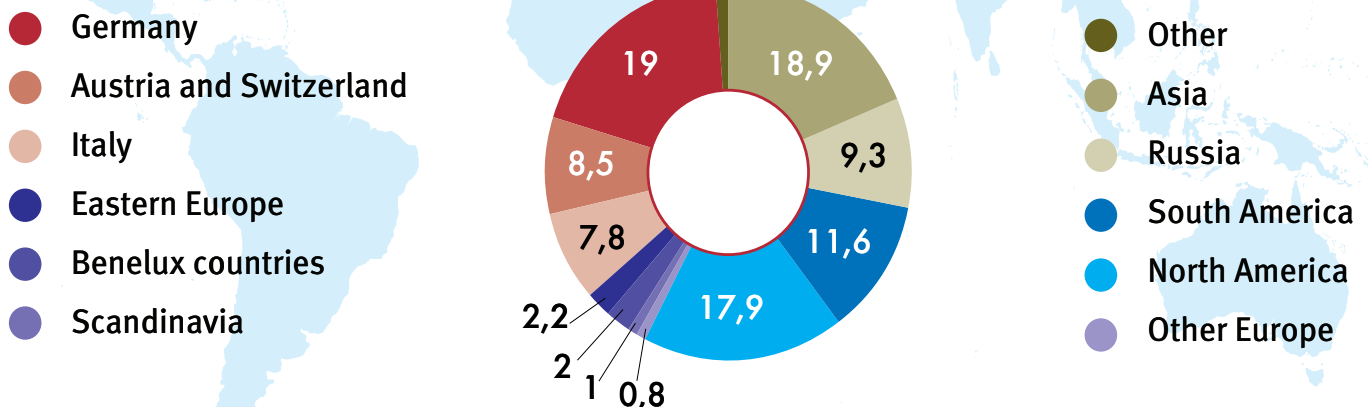

[www.smart-extrusion.com](http://www.smart-extrusion.com)

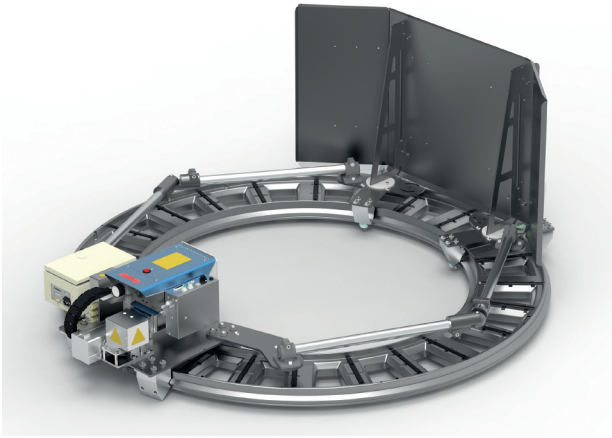

**36** 自1972年以来，新老员工一直开发和制造吹膜用测量和控制设备。以客户为导向的思维，结合最高的制造精度，使瑞士公司走向了世界之巅。  
*Since its inception in 1972, the KCS team has steadily climbed its way to being the world leader in the blown film industry.*

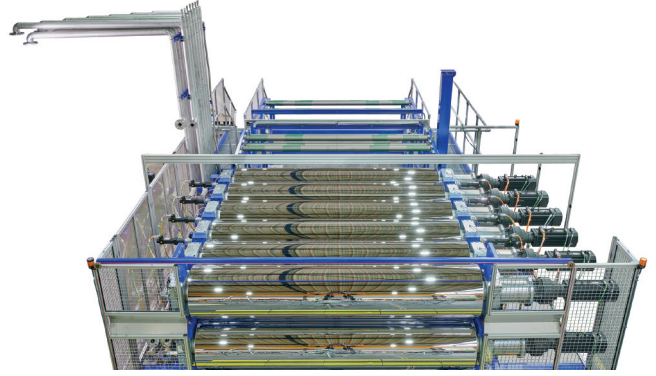

德国CLASSEN康麦森公司提供用于健康生活的可持续CERAMIN材料塑料地板，在一条配置Multi-Touch 压光辊的挤出生产整线上投产，该生产线来自德国巴顿菲尔辛辛那提公司。  
*The sustainable plastic floor boards made of CERAMIN by CLASSEN for healthy living are recently being produced on a complete extrusion line with a Multi-Touch roll stack from battenfeld-cincinnati Germany GmbH.*



**32** 在PET造粒的过程中，节能过程以及一定程度的结晶是非常重要的。当客户向ECON提出这一要求时，ECON作为技术领先者和值得信赖的开发伙伴，开始设计一款特别适合这些要求的水下造粒机。其结果是ECON PET-版，它已经针对PET进行了优化。  
*When it comes to pelletizing of PET, an energy saving process as well as a certain degree of crystallization is very important. When a customer approached ECON with this request, the technological leader and trusted development partner started to design an underwater pelletizer especially adapted to these requirements.*



K 2022：全球塑料和橡胶行业共同积极推动气候保护、循环经济和数字化进程  
*K 2022: Global Plastics and Rubber Industry Jointly Active for Climate Protection, Circular Economy and Digitalization*

莱芬豪舍流延片材涂布公司 ( Reifenhäuser Cast Sheet Coating ) ——莱芬豪舍集团专门从事流延膜、片材挤出和挤出涂层生产线的业务部门——开发了一种特别高效的生产工艺，可将PET回收物直接加工成食品级安全片材，而无需上游干燥工艺。  
*Reifenhäuser Cast Sheet Coating has developed a particularly efficient production process that allows PET recyclate to be processed directly into food-safe sheet without an upstream drying process.*

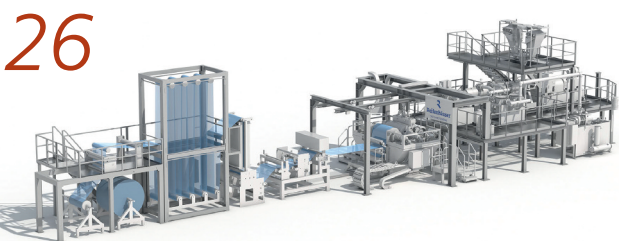

最近在新南威尔士州阿尔伯里市建成投产的澳大利亚循环塑料PET回收工厂配备了一条来自史太林格的recoSTAR PET 215 HC iV+ PET瓶到瓶回收线，该生产线每小时产能约为2.5吨rPET。  
*The recently opened Circular Plastics Australia PET recycling facility in Albury-Wodonga, New South Wales, is equipped with a recoSTAR PET 215 HC iV+ PET bottle-to-bottle recycling line from Starlinger that produces 2.5 tons of rPET per hour.*



# EXTRUSION

EXPERT MAGAZINE ON PLASTICS EXTRUSION

The only technical magazine worldwide exclusively for the sectors:

- Material Preparation
- Compounding
- Extrusion
- Recycling
- Calendering
- Thermoforming
- Welding
- Finishing of Plastics and Elastomers



**Extrusion** (German)

**Extrusion International** (English)

**Extrusion International USA** (English)

**Extrusion Russia Edition** (Russian)

**Extrusion Asia Edition** (Mandarin/English)

The only plastics trade magazine for Asia, published from Germany

8 issues a year

6 issues a year

6 issues a year

4 issues a year

2 issues a year

**SMART  
EXTRUSION**

All editions available for free:  
[www.smart-extrusion.com](http://www.smart-extrusion.com)

**VVA** Verlag GmbH Cologne/Germany



- 标题 / Front page:  
Guill Tool & Extrusion Co., Inc.  
www.guill.com
- 05 内容 / Content
- 06 企业短讯 / Branche Intern
- 20 挤出工具：  
充分利用您的挤出模具  
*Extrusion Tooling:  
Getting the Most from Your Extrusion  
Tooling*
- 24 片材挤压 - 案例研究：  
Multi-Touch压光辊生产塑料地板覆盖物  
有利于足部健康  
*Sheet Extrusion – Case Study:  
Multi-Touch Roll Stack is Good for our  
Feet*
- 26 挤出涂覆：  
EFSA合规工艺从PET回收物生产食品  
级安全片材  
*Extrusion Coating:  
EFSA-Compliant Process Produces Food-  
Safe Sheet from PET Recyclate*
- 28 测量技术——案例研究：  
确保海底电缆的最高质量  
*Measuring Technology – Case Study:  
Highest Quality of Submarine Cables  
Ensured*
- 30 塑料管：  
通过物理发泡电缆保护管减少二氧化碳  
并节约成本  
*Plastic Pipes: CO<sub>2</sub> Reduction  
and Cost Savings Through Physically  
Foamed Cable Protection Tubes*
- 32 准备工作：  
rPET/PET造粒的节能方案  
*Pelletizing: Energy-Saving Solution for  
Pelletizing of rPET/PET*
- 34 回收利用：  
来自奥地利的回收技术用于澳大利亚最  
大的PET回收厂  
*Recycling Technology from Austria for  
Australia's Largest PET Recycling Plant*
- 36 测量和控制技术, 公司周年庆：  
具有50年历史的KÜNDIG控制系统 - 一  
个成功的故事  
*Measuring and Control Technology:  
A Success Story –  
50 Years of KÜNDIG CONTROL SYSTEMS*
- 39  全球塑料和橡胶行业共同积极推动气候  
保护、循环经济和数字化进程  
*Global Plastics and Rubber Industry  
Jointly Active for Climate Protection,  
Circular Economy and Digitalization*
- 41 Sikora
- 44 battenfeld-cincinnati
- 47 Brückner Maschinenbau
- 48 Brückner Servtec
- 50 Kiefel
- 52 Reifenhäuser
- 54 KraussMaffei
- 55 Meaf
- 56 Palsgaard
- 58 Erema
- 58 Borealis
- 60 Addex
- 61 Starlinger
- 62 Lanxess
- 63 BASF
- 64 Domo
- 66 本期杂志中的公司目录 / 敬请垂询  
Firms in this issue / Imprint



### K 2022

19. - 26. 10. 2022

Düsseldorf / Germany

Dusseldorf / 德国

➡ [www.k-online.de](http://www.k-online.de)

### Plast Eurasia

23. - 26. 11. 2022

Istanbul / Turkey

伊斯坦布尔 / 土耳其

➡ [www.plasteurasia.com](http://www.plasteurasia.com)

### VietnamPlas

23. - 26. 11. 2022

Ho Chi Minh City / Vietnam

胡志明市 / 越南

➡ [www.chanchao.com.tw/Vietnamplas/](http://www.chanchao.com.tw/Vietnamplas/)

### INDIA ESSEN WELDING & CUTTING

23. - 25. 11. 2022

Bombay / India

Bombay / 印度

➡ [www.india-essen-welding-cutting.com](http://www.india-essen-welding-cutting.com)

### Chinaplas 2023

17. - 20. 04. 2023

Shenzhen / PR China

深圳 / 中国

➡ [www.chinaplasonline.com](http://www.chinaplasonline.com)

### interpack 2023

04. - 10. 05. 2023

Düsseldorf / Germany

Dusseldorf / 德国

➡ [www.interpack.de](http://www.interpack.de)

### PLAST 2023

05. - 08. 09. 2023

Milan / Italy

米兰 / 意大利

➡ [www.plastonline.org](http://www.plastonline.org)

### Interplas

26. - 28. 09. 2023

Birmingham / UK

伯明翰 / 联合王国

➡ [interplasuk.com](http://interplasuk.com)

## 展厅人流攒动：这是国际包装机械、包装及糖果机械展览会2023



■ 2023年5月4日至10日，杜塞尔多夫将再次成为商业平台和未来技术研讨会。国际包装机械、包装及糖果机械展览会（interpack）的展位已全部预订完毕。

18个展厅、目标展区、新的专业展览和论坛展示了行业的创新能力。来自世界各地约2700家参展商将展示整个价值链的领先技术和包装趋势。六年以来，除在疫情期间被迫停展，市场上有了许多新的发展。

尽管距离展会还有一年时间，但国际包装机械、包装及糖果机械展览会已经被预订一空，将占据整个展区。感兴趣的公司仍然可以注册等待名单，因此也有机会参展。

国际包装机械、包装及糖果机械展览会展示了连通性、安全性和可持续性等大趋势对不断发展的包装行业未来的影响。“资源稀缺和供应链中断等条件给该行业带来了巨大挑战，同时，需求增加、新技术和对可持续性的日益认识等因素为我们提供了大踏步前进的巨大机会，”国际包装机械、包装及糖果机械展览会项目总监托马斯·多斯（Thomas Dohse）说道，“国际包装机械、包装及糖果机械展览会是行业在全球层面创造未来的地方”。

国际包装机械、包装及糖果机械展览会为进步和有远见的概念提供刺激，并继续相应地扩展相应的计划。目前，有计划举办几场专业表演和论坛。例如，特别主题日确保访客收到目标信息。国际包装机械、包装及糖果机械展览会就利用这一点展示了对包装行业当

前挑战的答复。明年的活动将特别关注于循环经济、节约资源、数字技术和产品安全等主题。

在展会期间之外，国际包装机械、包装及糖果机械展览会的数字通信平台Tightly Packed也随时掌握着其脉搏，并继续提供有关新发展、最佳实践和趋势的信息。

### The Halls are Packed: This is interpack 2023

■ From May 4 to 10 2023, Düsseldorf will once again become a business platform and future technology workshop. interpack has already been fully booked out. 18 halls, targeted exhibition areas, new speciality shows and forums demonstrate the industry's innovative prowess. Around 2,700 exhibitors from around the world will present leading technology and packaging trends from the entire value chain. Six years and a forced absence during the pandemic mean that there is a multitude of novel developments on the market.

Although there is still a year before the event, interpack has already been fully booked out and will occupy the entire exhibition area. Interested companies can still register for the waiting list and thus have the chance to exhibit too.

interpack demonstrates the influence that megatrends like connectivity, security and

sustainability have on the future of the continuously evolving packaging industry. "Conditions like scarcity of resources and disrupted supply chains pose great challenges to the industry, while simultaneously factors such as increasing demand, new technology and a growing awareness of sustainability offer us big chances to take huge strides forward," says Thomas Dohse, Project Director for interpack. "interpack is the place where the industry creates the future at a global level".

interpack delivers stimuli for progressive and visionary concepts, and continues to expand the accompanying programme accordingly. At the moment, there are plans for several speciality shows and forums. For example, specially themed days ensure that visitors receive targeted information. interpack uses this to demonstrate answers to current challenges within the packaging industry. Next year's event will specifically focus on the topics of circular economy, saving resources,

digital technology and product safety. Outside exhibition times, too, interpack's digital communication platform Tightly Packed keeps its finger on the pulse and continues to offer information on new developments, best practices and trends.

➔ **Messe Düsseldorf GmbH**  
[www.interpack.de](http://www.interpack.de)

# Precision Wall Thickness Measurement

**Zumbach**  
 SWISS PRIME MEASURING SINCE 1957

## RAYEX S

- Easy and quick set up for new products
- Fast eccentricity and diameter measurement
- Added longevity due to high-quality xray source



19. - 26. 10. 2022  
 Düsseldorf, Germany  
 Stand: 10E 27

Family owned since 1957, Zumbach is a global leader in the industry. Driven by innovation and experience. We are here for you and ready to build the future together.

[www.zumbach.com](http://www.zumbach.com) • [sales@zumbach.ch](mailto:sales@zumbach.ch)

## 稳定再生塑料

■ 3T Industries 私人有限公司,是马来西亚领先的回收公司,专业处理工业后和消费后回收物,巴斯夫目前正与3T公司一起,在帮助马来西亚的菠萝种植园提高产量并节省资源。公司首次应用巴斯夫的 IrgaCycle™ UV033 DD 技术来增强用作菠萝保护层的 100% 回收高密度聚乙烯 (HDPE) 板材。

虽然菠萝需要温暖潮湿的气候,但它们很容易受到太阳辐射和高温(高于 32°C)的损害,高温会极大降低菠萝的可销售产量,并严重损害种植者的收入。经高温损害过的菠萝会产生包括晒伤或脱色症状,表现为表皮黄白色,且表皮下组织受损后会变成浅灰色或棕色。这种受损的组织很容易受到疾病和侵染的影响。HDPE 保护剂可保护水果免受阳光直射,同时水果仍可进行光合作用。

“专门针对农业领域的塑料添加剂很大程度上是按需求定制的,可满足客户对增强作物保护解决方案的关键需求。”高性能化学品亚太区高级副总裁 Hermann Althoff 说。“我们为所有关于提高回收料质量的问题提供全面的客户支持,使它们在新的应用中成为适合的材料。”

以前,3T Industries 使用抗氧化剂和光稳定剂的组合来达到种植者规定的性能要求——HDPE 保护剂需要持续四个季节的预期使用寿命。

IrgaCycle 提供一包解决方案,可立即供回收商使用,无需进一步预混合。与传统的抗氧化剂系统相比,它在较低浓度下也更有效,并减少了所需添加剂的总量。这样可以轻松准确地进行配量,提高产品质量,并升级回收物以用于长期应用。

“我们利用我司在回收技术和消费后树脂方面的专业知识,为消费者和社区提供更好的解决方案,”3T Industries 执行董事 PH Tan 说。“通过 Irga Cycle,我们能够使用回收原料来设计一种新产品,该产品具有大量可回收成分,并使农业塑料变得更加可持续成为可能。”

巴斯夫不仅为 3T Industries 提供合适的添加剂解决方案,还为在加工和户外风化过程中稳定回收聚合物提供技术建议。这一点很重要,因为回收材料的有效和可持续应用取决于工艺条件和改性剂的优化等。

2021 年推出的 IrgaCycle,由一系列塑料添加剂配方组成,可将再生塑料与原始材料结合,重新用于生产高价值塑料。该添加剂解决方案解决了与再生

树脂相关的特定质量问题,例如有限的可加工性、较差的长期热稳定性以及对户外风化的保护不足。

IrgaCycle 系列作为 VALERAS™ 产品组合的一部分提供。除了通过 IrgaCycle 实现塑料循环之外,VALERAS 解决方案还通过提高耐用性、节约能源以及减少废物和排放,为塑料应用带来可观的可持续性价值。

### Stabilizing Recycled Plastics

■ BASF and 3T Industries Sdn Bhd, a leading recycling company in Malaysia dealing with post-industrial and post-consumer recyclates, are helping pineapple plantations in Malaysia to increase their yields and save resources. For the first time, 3T Industries has applied BASF's IrgaCycle™ UV033 DD to enhance 100% recycled high density polyethylene (HDPE) sheets used as protectors for pineapples.

While pineapples require a warm and humid climate, they are susceptible to damage from solar radiation and high temperatures (> 32°C) which can significantly reduce marketable yield and cut deep into a grower's profit. Symptoms include sunburn or bleaching which are visible as yellow-white skin that turns pale grey or brown upon damage to the tissue underneath. This damaged tissue is susceptible to disease and infestation. The HDPE protector shields the fruit from direct sunlight while still allowing photosynthesis to occur.

“Plastic additives specifically for the agricultural sector are highly customized to fulfil critical customer needs for enhanced crop protection solutions,” says Hermann Althoff, Senior Vice President, Performance Chemicals Asia Pacific. “We offer full customer support in all questions of quality improvement of recyclates to make them viable materials in new applications.”

Previously, 3T Industries used a combination of antioxidants and light stabilizers to achieve the performance requirements stipulated by the grower – the HDPE protectors needed to last through the intended service lifetime of four seasons.

IrgaCycle offers a one-pack solution that is immediately available for the recycler

without the need for further premixing. It is also more efficient at lower concentrations compared to traditional antioxidant systems and reduces the overall quantity of additives required. This results in easy and accurate dosing, improved product quality, as well as upgraded recyclate for use in long-term applications.

“We use our expertise in recycling technology and post-consumer resins to provide better solutions to consumers and communities,” says PH Tan, Managing Director of 3T Industries. “With IrgaCycle, we were able to use recycled feedstock to design a new product that features a high amount of recyclate content and makes more sustainable agricultural plastics possible.”

BASF not only provided 3T Industries with the suitable additive solution, but also the technical recommendations to stabilize the recycled polymers during processing and outdoor weathering. This is important as an effective and sustainable application of recycled materials depends on, amongst others, the optimization of process conditions and modifying agents.

Launched in 2021, IrgaCycle consists of a series of plastic additive formulations, which enable recycled plastics to be re-used for the production of high-value plastics in combination with virgin materials. The additive solution addresses specific quality issues associated with recycled resins, such as limited processability, poor long-term thermal stability and insufficient protection from outdoor weathering.

The IrgaCycle range is offered as part of the VALERAS™ portfolio. In addition to enabling plastics circularity with IrgaCycle, VALERAS solutions bring significant sustainability value to plastic applications by improving durability, saving energy, as well as reducing waste and emissions.

### ► BASF Plastic Additives

[www.plasticadditives.basf.com](http://www.plasticadditives.basf.com)

[www.performancechemicals.basf.com](http://www.performancechemicals.basf.com)



## 感谢与中国BOPP薄膜巨头的合作，提供分切复卷机并展望新增生产线

福建福尔普新材料有限公司是中国BOPP薄膜产品生产和销售的三大龙头企业之一。这家中国工业巨头打算到2025年在中国西南部和东南部新建两个生产基地，这样总共有6个生产基地，30条BOPP生产线。这一庞大的工业发展计划将有助于提高集团的生产潜力，该集团打算成为世界上最大的BOPP薄膜生产商。

2021年签署的协议是提供16台格贝尔IMS MONOSLIT 9000 BOPP分切复卷机，这为伟大的友谊奠定了坚实的基础，IMS技术支持了中国制造商的雄心勃勃的工业计划。另一项协议预计将于2022年敲定，为另外6条BOPP生产线提供额外的主分切复卷机，福尔普先进材料公司已经在2022年初订购了这些设备。

与中国集团的业务关系基于专业、可靠性、合作和创新的共同价值观:IMS TECHNOLOGIES技术是智能制造计划的一部分，旨在生产能够提高福尔普先进材料在国际市场上竞争力的创新技术产品。

格贝尔分切和卷绕系统有限公司董事总经理兼薄膜销售总监Tobias Lankswirt补充道:“这样一个项目在我们的历史上是独一无二的，我们非常自豪和感谢福尔普对格贝尔IMS的信任。通过这个项目，我们再次表明，在主分切和复卷方面，特别是在高速BOPP转换领域，我们是世界市场的领导者。我们期待与福尔普进行长期而富有成效的合作。”

### Supply of Slitter Rewinders and Outlook for Additional Lines Thanks to Relationship with Chinese BOPP Film Giant

Fujian Forop Advanced Materials is one of the top three leading companies



in the Chinese market for the production and sale of BOPP film products. The Chinese industrial giant means to start-up two new production sites in southwest and southeast China by 2025, leading to a total of six production sites with 30 BOPP production lines. This huge industrial development will serve to boost the production potential of the group, which intends to become the largest producer of BOPP film in the world.

The agreements signed in 2021 for the supply of 16 GOEBEL IMS MONOSLIT 9000 BOPP slitter rewinders create the solid basis for a great partnership, in which IMS TECHNOLOGIES supports the Chinese manufacturer in its ambitious industrial plan. A further agreement is expected to be finalized in 2022 that will bring additional primary slitter rewinders for another 6 BOPP production lines, already ordered by Forop Advanced Materials at the beginning of 2022.

The business relationship with the Chinese group is based on the shared values

of profession, reliability, cooperation and innovation: IMS TECHNOLOGIES technology is part of a smart manufacturing plan aimed at the production of innovative technical products able to increase the Forop Advanced Materials competitiveness on international markets.

Tobias Lankswirt, Managing Director of GOEBEL Schneid- und Wickelsysteme GmbH and Sales Director Film adds: “Such a project is unique in our history, we are very proud and thankful that FOROP put its trust in GOEBEL IMS. With this project we show once more that we are the world market leader if it comes to primary slitting and rewinding, especially in the field of high-speed BOPP converting. We are looking forward to a long and fruitful cooperation with FOROP.”

- ➔ IMS TECHNOLOGIES Spa [www.imstechnologies.com](http://www.imstechnologies.com)
- ➔ Fujian Forop Advanced Materials Co. Ltd. <https://fjfurong.en.alibaba.com/>



DISCOVER OUR WIDEST RANGE OF INNOVATION  
**OUR NEW 8-SERIES WITH 20 NEW MODELS**



## 投资扩大全球影响力、生产能力和本地客户支持

■ UniteChem 集团宣布，它已经开始了雄心勃勃的扩张之旅，对其全球生产能力和本地客户支持进行了重大投资。凭借超过 20 年的市场经验，UniteChem 集团决心通过对客户提供优质服务、长期合作和优化的产品解决方案，创造集团价值、实现行业目标，并获得最终成功。

“在过去的 20 年里，我们一直致力于将创新光稳定剂和其他性能添加剂方面的专业知识传播到中国以外，以满足全球不断增长的客户需求。”UniteChem 集团首席执行官 Junyi Lin 表示。“我们目前的投资遍及各个层面，我们增加了生产、研发、本地销售和物流能力，以更贴近上下游客户；恪守我们的价值观“信任、合作和卓越”，我们将继续保持供应安全。”

UniteChem 的重要优势之一是其坚实的后向集成，可提供广泛的生产灵活性、高可靠性和最大的质量控制。随着现有宿迁（江苏）厂房的扩建，集团目前的 8 万吨中间体产能将增加至 30 万吨以上。此外，我们计划于 2022 至 2024 的 3 年间，在南充（四川）、盛金和盛瑞（均在江苏）3 地投产 3 座新工厂。这些重大投资还将使集团能够在其生产中整合更多中间体，并支持新添加剂解决方案的可用性。

我们成品产能将增加 50,000 吨，即增加一倍以上，以满足客户对现有产品和新产品不断增长的需求。例如，我们拥有采用新型环保工艺生产的紫外线吸收剂、成核剂和其他稳定剂。在扩建中的宿迁工厂，我们还采用了一种新的、更可持续的技术，在专有的催化加氢还原工艺中合成苯并三唑类紫外线吸收剂。

此外，按照联合国可持续发展目标，UniteChem 集团兑现可持续承诺，目前正在其生产基地投资专门回收、再利用和减排举措。现今的能力包括使用再生热氧化 (RTO) 技术处理 280,000 m<sup>3</sup>/小时的废气、每天处理 1,800 m<sup>3</sup> 的废水和每年处理 8,800 吨的固体化学废物。

UniteChem 集团于 1997 年开始生产行业标准的光稳定剂，例如 LS-944。此后一直在不断扩大其聚合物添加剂组合。最近商业化的 HALS（受阻胺光稳定剂）产品包括 LS-2020，可用于聚烯烃和其他聚合物材料的纤维和纤网；以及 LS-119，主要用于农业、温室和工程聚合物在汽车中的应用。

即将商业化的将是 LS-4050（2023 年），一种用于厚壁物品的低分子量

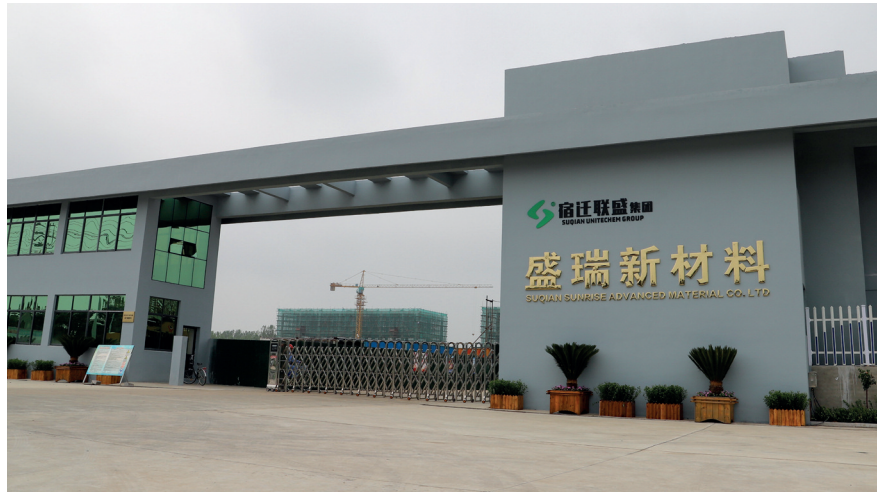

UniteChem 集团宣布，它已经开始了雄心勃勃的扩张之旅，并在各个层面进行了重大投资。这一增长战略的基石是显著增加现有和新性能添加剂的生产能力，以及特别关注欧洲市场的进一步支持和物流能力（照片：UniteChem）

*UniteChem Group has announced that it has departed on an ambitious expansion journey with major investments across all levels. Cornerstones of this strategy for growth are significant additions in production capacity for existing and new performance additives as well as further support and logistics capabilities with a particular focus on Europe (Photos: UniteChem)*

HALS，以及几种无卤素双酚 A 双（磷酸二苯酯）BDP 和焦磷酸哌嗪 (PAPP) 阻燃剂，用于要求严格的组件，例如多光纤推入式 (MPO) 连接器，还可用于汽车零件和光纤的两种高温聚酰胺 (PA) 稳定剂。

继在比利时安特卫普建立主要仓库，并在杜塞尔多夫开设销售办事处后，UniteChem 集团扩大欧洲业务的下一步将是使其员工人数翻倍，并使其技术支持更贴近当地客户。欧洲销售团队将招募更多经验丰富、具有很强行业背景、且精通不同种语言的市场专家，以确保更快的市场反应和与建立与客户的持久伙伴关系。

UniteChem 集团还正在其他欧盟国家寻找更多潜在的物流站点，例如意大利。旨在提高产品样品的可用性，并加快创新应你用的上市时间。除了建立本地仓库网络外，供应安全还得到了来自中国几个不同主要港口的运输支持，其中包括 UniteChem 的一个主要仓库所在地——广州，以及上海、青岛、天津和连云港。

致力于为客户投资未来解决方案，UniteChem 集团定期将其总收入的 5% 用于研发，集团拥有 5 个独立实验室——包括最近开设的现代化上海研发中心。为确保重大投资特别是产能和投资

组合扩张的资金，UniteChem 集团目前正在上海证券交易所申请首次公开募股 (IPO)，集团预计将于 2022 年 12 月左右正式上市。

### *Investment in the Expansion of Global Presence, Production Capacities and Local Customer Support*

■ UniteChem Group has announced that it has departed on an ambitious expansion journey with major investments in global production capacity and local customer support. Building on more than 20 years of experience in the market, the Group is determined to create value, deliver success and meet industry targets through highly responsive, long-term collaboration with customers and optimized product solutions.

“Over the past two decades, we have been taking our expertise in innovative light stabilizers and other performance additives beyond China to meet the demands of a growing customer base worldwide,” says Junyi Lin, CEO of UniteChem Group. “Our current investments

extend across all levels, adding production, R&D, local sales and logistic capacities to get closer to upstream and downstream customers and maintain security of supply in line with our key values of Trust, Partnership and Excellence.”

One of the important strengths of UniteChem is its solid backward integration, providing extensive production flexibility, high reliability and maximum quality control. The Group’s current 80,000 tons capacity for intermediates is being ramped up to more than 300,000 tons with an expansion of its existing Suqian (Jiansu) facilities. In addition, three new plants are scheduled to come on-stream in 2022/2024 at Nanchong (Sichuan), Shengjin and Shengrui (both Jiangsu). These significant investments will also allow UniteChem to integrate further intermediates in its production and support the availability of new additive solutions. Capacity in finished products will be more than doubled by an increase of 50,000 tons to meet growing customer demands for both existing and new products, such as UV absorbers – produced in a novel environmentally friendly process – as well as nucleating agents and other stabilizers. At its expanding Suqian site, UniteChem is also adopting a new and more sustainable technology for synthesizing benzotriazole UV absorbers in a proprietary catalytic hydrogenation reduction process.

Moreover, as part of its commitment to sustainability in line with the Sustainable Development Goals of the United Nations, the Group is investing in dedicated recycling, reuse and reduction initiatives at its production sites. Installed capabilities today include 280,000 m<sup>3</sup>/hr of waste gas treatment using regenerative thermal oxidization (RTO) technology, 1,800 m<sup>3</sup>/day of waste water treatment, and 8,800 tons/year of solid chemical waste treatment.

UniteChem Group began producing industry-standard light stabilizers such as LS-944 in 1997 and has been continuously expanding its polymer additives portfolio ever since. Recently commercialized HALS (hindered amine light stabilizer) products have included LS-2020 for fibers and webs of polyolefin and other polymer materials, and LS-119 mainly for agricultural, greenhouse and engineering polymer applications in automotive etc. Soon to be commercialized will be LS-4050 (in 2023), a low-molecular weight HALS for thick-wall items, as well as se-

veral halogen-free bisphenol A bis(diphenyl phosphate) BDP and piperazine pyrophosphate (PAPP) flame retardants for demanding components such as multi-fiber push on (MPO) connectors, and two high-heat polyamide (PA) stabilizers for automotive parts and fibers.

After establishing a major warehouse in Antwerp, Belgium, and opening a Sales office in Düsseldorf, the next steps in expanding the European footprint of UniteChem will be to double its workforce and bring its technical support even closer to local customers. Experienced market specialists with strong industry focus and covering additional languages will be added to the European Sales Team, ensuring faster response and lasting partnerships.

The Group is also looking at potential further logistic sites in other EU countries, e.g. Italy, to improve the availability of product samples and accelerate the time-to-market of innovative new applications. Apart from building a network of local warehouses, security of supply is backed

by shipments from several different key ports in China, including Guangzhou, where UniteChem operates a major warehouse, as well as Shanghai, Qingdao, Tianjin and Lianyungang.

As part of its commitment to invest in future solutions for its customers, UniteChem Group regularly allocates five percent of its total revenue to R&D, operating five independent laboratories – including its recently opened modern Shanghai R&D Center. In order to secure the funding of major investments especially in capacity and portfolio expansion, the Group is currently filing for initial public offering (IPO) at the Shanghai Main Stock Exchange and expects to become officially listed around December 2022.

➔ **UniteChem Group**  
[www.unitechem.eu](http://www.unitechem.eu)  
**K 2022: Hall 8a, Stand E33**  
**K 2022: 8a展厅, E33展台**



**ERGE Elektrowärmetechnik - Franz Messer GmbH**  
 91220 Schnaittach - Hersbrucker Straße 29-31  
 Tel. +49/9153/921-0 Fax +49/9153/921-117  
[www.erge-elektrowaermetechnik.de](http://www.erge-elektrowaermetechnik.de)  
 mail: [verkauf@erge-elektrowaermetechnik.de](mailto:verkauf@erge-elektrowaermetechnik.de)

HEIZEN
HEATING



TROCKNEN
DRYING

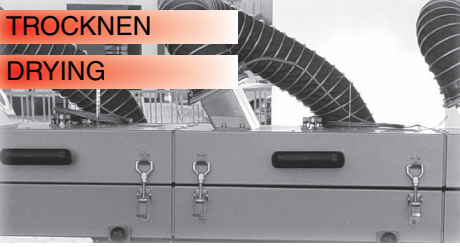

REGELN
CONTROLLING

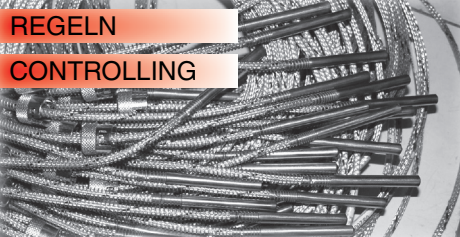



ELEKTROWÄRMETECHNIK FRANZ MESSER GMBH

## 创造纪录的一年

■ 在受到旅行限制和封锁影响的一年里，这家领先的表面处理技术设备制造商打破了此前的所有销售记录。

自 2020 年 4 月开始第一次封闭以来的这段时间，对世界贸易和公司业务开展的方式产生了重大影响，然而 Vetaphone（丹麦威钛锋公司）非常高兴地报告说，订单全面大幅度增长，年终总订单量回升。这不仅超出预期，而且超过了公司悠久历史中的以前所有年份。

销售和营销副总裁 Kevin McKell 代表公司发言时解释说：“我们迅速评估了情况，并调整了我们的销售和营销方法，以适应新的贸易条件。由于旅行成为了不可能或受到严重限制，我们不得不寻找与客户面对面接触的替代方式，而我们采取的行动显然效果很好！”

随着贸易展览会的取消，Vetaphone 做出了大胆的决定，不再参加未来的所有大型或小型展会活动。相反，该公司于 5 月份正式开设了新的陈列室和演示设施，该设施可以运转，并完整地配备了电晕和等离子技术，通过视频链接提供面对面交谈和在线预约。与 2020 年开设的相邻测试实验室设施相结合，Vetaphone 就拥有了自己的永久贸易展台，如有必要，可每周 7 天每天 24 小时全天候开放。

营销总监 Jeannette Woodman 解释说：“我们的客户对新展厅反应非常好，而且我们可以实际演示设备——这是我们在介绍 Drupa 或 Labelexpo 产品时永远无法做到的——而且它真的开始在获得订单方面带来红利。我们知道，我们的许多客户不太可能在丹麦拜访我们——现在我们可以将我们的技术带给他们，无论他们在世界的哪个地方。”

新的贸易条件也对公司如何宣传自己和推广其活动产生了影响。他补充道：“我们很快将我们的重点从‘粗枝大叶’的方法转移到更加专注于世界不同部门和地区的方法。通过改进我们对最新计算机和电子通信技术的使用，我们能够以特定个体需求的信息影响目标市场——而费用只是参加大型国际博览会的一小部分！”

对于 Vetaphone 而言，新的贸易条件开启了新的商机，2021 年除了成为创下销售记录的年份外，该公司在表面处理技术领域的业绩跃居全球第一。正如 Kevin McKell 所说：“我们取得了第一位，在我们的 70 年历史中，获得第一是一项非凡的业绩。2022 年加油！”



在丹麦新设立的陈列室是现场在线不间断演示表面处理技术的展示厅

*The newly opened Showroom in Denmark is a permanent display of working surface treatment technology for in-person or online presentations and demos*

### Record Year Reported

■ In a year blighted by travel restrictions and lockdowns, the leading manufacturer of surface treatment technology beats all previous sales records.

The period since the first lockdown began in April 2020 has had a major impact on world trade and the way companies do business, so Vetaphone is more than happy to report a huge boost in orders across the board that saw it return a year-end total that will not only surpass expectations but exceed all previous years in the company's long history.

Speaking for the company, VP Sales & Marketing Kevin McKell explained: "We were quick to assess the situation and adapt our sales and marketing approach to suit the new trading conditions. With travel either impossible or severely limited we had to find alternative ways for face-to-face contact with customers, and the actions we took have clearly worked well!"

With trade fairs being cancelled on a rolling basis, Vetaphone took the bold decision to withdraw from exhibiting at all future events, whether large or small. Instead, the company officially opened its new Showroom and Demo facility in May that is fully equipped with working corona and plasma technology and offers both in-person and online appointments via a video link. Allied to the adjacent Test Lab facility that it opened in 2020, Vetaphone now has a permanent trade fair stand of its own that is available 24/7, if necessary.

"We've had great customer response to the new showroom and the fact that we can actually demonstrate the equipment – something we could never do at Drupa or Labelexpo – and it's really started to pay dividends in terms of orders secured. We know that many of our customers are unlikely to ever visit us in Denmark – now we can take our technology to them wherever they are in the world," he added.

The new trading conditions also had an impact on how the company promoted itself and publicised its activity. Marketing Director Jeannette Woodman explained: "We quickly switched our focus from a 'broad-brush' approach to one that is far more zoned in on the different sectors and parts of the world. By refining our use of the latest in computer and electronic communications we have been able to impact target markets with information that is specific to individual requirements – and at a fraction of the cost of attending a major international expo!"

For Vetaphone, the new trading conditions have opened new business opportunities, and in addition to reporting a record sales year, 2021 has seen the company move to the No 1 spot worldwide in surface treatment technology. As Kevin McKell put it: "We were the first, so to be at No 1 in our 70th year is a fantastic achievement. Bring on 2022!"

► Vetaphone A/S  
www.vetaphone.com

## BASF SE 最终批准了建设湛江一体化基地

■ 建设计划中的一体化基地位于中国南部广东省湛江。该项目正在按日程进行。现在的重点是建设一体化联合体的核心，其中包括一个蒸汽裂解装置和几个用于生产下游工厂石化产品和中间体的装置，到 2030 年，巴斯夫将投资高达100 亿欧元建设新一体化地点。

2020年，巴斯夫开始建设计划中的一体化中国湛江基地，继德国路德维希港和比利时安特卫普之后，第一批工厂成为巴斯夫第三大一体化基地。基地将分几个阶段建成，预计将到 2030 年全面投入运营。第一个生产工程塑料的工厂塑料目前正在启动。生产热塑性塑料聚氨酯 ( TPU ) 的工厂即将于2023 年投入使用。

### *Final Approval for the Construction of the Zhanjiang Verbund Site Given*

■ BASF SE gave final approval for the construction of the planned Verbund site in Zhanjiang in the southern Chinese province of Guangdong. The project is on schedule. The focus will now be on building the core of the Verbund, which includes a steam cracker and several downstream plants for the production of petrochemicals and intermediates, among others. BASF will invest up to Euro 10 billion by 2030 to build the new Verbund site.

In 2020, BASF started construction of the first plants at the planned integrated Verbund site in Zhanjiang, China, which will be BASF's third-largest Verbund site worldwide after Ludwigshafen, Germany, and Antwerp, Belgium. The site will be built in several phases and is expected to be fully operational by 2030.

The first plant for the production of engineering plastics is currently starting up and a plant for the production of thermoplastic polyurethanes (TPU) will come on stream in 2023.

➔ **BASF SE**  
www.basf.com

# Your Profile    Our Business    50 Years





Hall 10

Booth C51

**50<sup>th</sup>**  
ANNIVERSARY  
1972 - 2022

**KÜNDIG CONTROL SYSTEMS**  
The Gauge Manufacturer for Film Extrusion 

## 高纯度交联聚乙烯电缆绝缘胶的生产

■ 布斯 (Buss) 公司已与雷普索尔 (Repsol) 公司签署一项合同, 为可交联聚乙烯XLPE电缆绝缘胶建造一座2.7万吨/年的生产厂, 雷普索尔是一间全球多能源公司, 为不同类型的电缆提供广泛的解决方案。

新的专利LSHC™ (“短、超洁净线性元件”) 工艺由布斯公司与P&M线缆咨询有限责任公司 (P&M Cable Consulting LLC) (是一间总部位于瑞士的电缆绝缘胶领域的咨询公司) 密切合作开发了该工艺。该工艺提供了各种高压 (HV) 和超高压 (EHV) 的接入与众所周知的浸泡技术相比, 具有优异的产品质量和工艺效率。交流 (AC) 电缆或直流 (DC) 电缆应用的XLPE等级很容易通过这种创新和灵活的工艺生产。

LSHC™ 技术依靠直接注入过氧化氢和使用布斯最先进的COMPEO™ 混合捏合机系列对新开发的添加剂混合物进行温和混合, 同时允许显著降低资本支出和洁净室要求。进一步的优点是紧凑的设备设计, 无需高层均热塔, 并改善了生产材料的清洁度和物理电气性能。

布斯公司很荣幸能与雷普索尔公司合作, 实现这一第一个同类工业生产工厂, 并将热切地继续为计划于2024年年中计划启动项目, 进行出色的合作。LSHC™ 技术在有竞争力的授权模式基础上, 全球范围内的布斯客户可以使用该技术。今年年底左右, 将在瑞士普拉特恩的巴斯学校 (BUSS Campus) 建立相应的高压和超高压材料生产试验工厂。

### Production of High-Purity XLPE Cable Compounds

■ Buss has been awarded a contract for the realization of a 27kta production plant for crosslinkable polyethylene XLPE cable compounds by Repsol, a global multi-energy company offering a wide range of solutions for different types of cables.

The new, patented LSHC™ process („Linear Short Hyper Clean“) has been developed by Buss AG in close cooperation with P&M Cable Consulting LLC, a Swiss based consulting firm in the field of cable compounds. It offers access to, among others, various High Voltage (HV) and Extra High Voltage (EHV) insulation materials, exhibiting superior product quality and process efficiency compared to the



雷普索尔 (Repsol) 公司将采用首创的节能工艺, 基于布斯 (BUSS) 公司的LSHC™ 工艺 (短、超洁净线性元件) 生产高纯度交联聚乙烯电缆绝缘胶 (©巴斯/百叶窗 (Buss/Shutterstock) )

*Repsol will use a first-of-its-kind energy-efficient process to produce high-purity XLPE cable compounds, based on BUSS' LSHC process (Linear Short Hyper Clean) (© Buss/Shutterstock)*

well-known soaking technology. XLPE grades for both, alternating (AC) or direct current (DC) cable applications are readily produced with this innovative and flexible process.

The LSHC™ technology relies on direct peroxide injection and gentle compounding of a newly developed additive cocktail by using BUSS state-of-the-art COMPEO™ co-kneader series, allowing at the same time for significantly reduced capital expenses and clean room requirements. Further advantages are the compact plant design without high-rise soaking tower and improved cleanliness and physical-electrical properties of the produced materials.

Buss AG is proud to work with Repsol on the realization of this first-of-its-kind industrial production plant and will eagerly continue the excellent collaboration towards the scheduled start-up in mid-2024. The LSHC™ technology is available to BUSS customers world-wide on the basis of a competitive licensing model. A corresponding pilot plant for production of HV and EHV materials will be available around the end of this year at the BUSS Campus in Pratteln, Switzerland.

➔ **BUSS AG**  
www.BUSScorp.com

## 加入联合国全球契约

■ 自2022年3月13日起, Starlinger 已是联合国全球契约的签署企业之一, 该契约是联合国与超过 15,000 多个官方成员组织为可持续未来而共同努力的全球性契约。通过此次加入, Starlinger 声明尊重人权、劳工标准、环保和反腐败等核心主题, 并自愿设立法律规定以外的规定措施。“作为一家全球性企业, 我们对社会和环境负有重大责任”, Starlinger 的管理合伙人 Angelika Huemer 强调道。“通过参与联合国全球契约以及我们最近指定的企业社会责任 (CSR) 指导方针, 我们希望我们的业务合作伙伴和我们的员工, 将联合国全球契约的十项原则全面融入到我们的业务实践中。”

作为全球最大的企业可持续发展倡议, 联合国全球契约提倡企业不仅要承认而且还要承担其社会责任。Starlinger 可持续发展官 Clarissa Graf 将此次全球性活动视为发展未来可持续性的一次契机。“通过加入联合国全球契约的契机, 敦促公司全面深入研究企业社会责任主题并查明现状, 以便能够设定长远目标”, Graf 如是说。“此外, 还将通过强制性年度报告定期对措施和目标实现情况进行评估 - 只有这样才能保证我们步入正轨。我很高兴 Starlinger 接收此次挑战!”

**Joining UN Global Compact**

■ On 13 March 2022, Starlinger became one of the signatory companies of the UN Global Compact, a global pact between the United Nations and over 15,000 official members who are committed to working together for a sustainable future. By joining the UN Global Compact, Starlinger has pledged to uphold core issues such as human rights, labour standards, environmental protection and anti-corruption, and to voluntarily take measures that go beyond the legal requirements. "As a company that is active on the world stage, we have a significant responsibility towards society and the environment," emphasises Angelika Huemer, Managing Partner at Starlinger. "With our participation in the UN Global Compact, and the Corporate Social Responsibility (CSR) policy that we established recently, we want to demonstrate to our business partners and our workforce that we are commit-

ted to fully integrating the ten principles of the UN Global Compact into our business practices."

As the world's largest initiative for corporate sustainability, the UN Global Compact is a tool that enables companies not only to recognise their social responsibility, but also to shoulder it. Clarissa Graf, Sustainability Officer at Starlinger, sees this global movement as an opportunity to shape a more sustainable future. "Companies that join the UN Global Compact are called upon to comprehensively address the issue of CSR and to ascertain the status quo, thus enabling them to set ambitious goals," says Graf. "Given the fact that annual reporting is mandatory, regular evaluation of the measures and the achievement of objectives also takes place. This is the only way to ensure that we are heading in the right direction. I am delighted that Starlinger is rising to this challenge!"



Angelika Huemer, Managing Partner Starlinger & Co Ges.m.b.H.

- ➔ Starlinger & Co Ges.m.b.H. [www.starlinger.com](http://www.starlinger.com)
- ➔ UN Global Compact [www.unglobalcompact.org](http://www.unglobalcompact.org)

# MEDIAKIT 2023

# EXTRUSION

EXPERT MEDIA ON PLASTICS EXTRUSION

[www.smart-extrusion.com](http://www.smart-extrusion.com)
**VM** Verlag GmbH Cologne/Germany
print | online | digital

## 出新型500系列橡胶/硅胶挤压十字头

■ Guill Tool推出了具有MAGS胶空间调节系统的新型500系列十字头。500系列专为弹性体化合物的流动特性和独特的加工挑战而设计。Guill推出的这种新型十字头设计的关键特性之一是机械辅助胶空间(MAGS)调节系统。新的胶空间调节方法使操作员可以使用普通套筒扳手从单点进行轻松调节。调节胶空间时无需多个螺母和螺栓,这可以缩短调节时间。核心管上的视觉指示灯让操作员能够查看胶空间移动了多远,使调节更加准确且可重复。

Guill推出的新型500系列无需硬件并采用专利凸轮锁设计,无需浪费时间拆卸和重新固定紧固件,便于拆卸和重新组装。只需将凸轮螺母转半圈即可松开并自动从十字头头部取出导流板,这进一步节省了时间。此外,导流板上没有底切,在取出导流板时无需挂起任何材料,从而可以更快、更轻松地进行清洁和转换。

新型500系列还采用了最新的中央平台同心度调节系统,可显著降低工具压力,可以在不松动端面螺栓的情况下更轻松、更精确地进行同心度调节。用于调节螺栓的易取插件还允许轻松地更换锁定或损坏的调节螺栓,从而进一步减少维修费用并减少宕机时间。

这种新型橡胶/硅胶十字头的另一个创新特点是铸铝液体冷却套管,让用户可以在发生线路阻塞时切换冷却套管,与传统集成冷却系统相比,进一步减少了宕机时间。

Guill 500系列十字头,具有机械辅助胶空间(MAGS)调节系统.....专为弹性体化合物的流动特性而设计

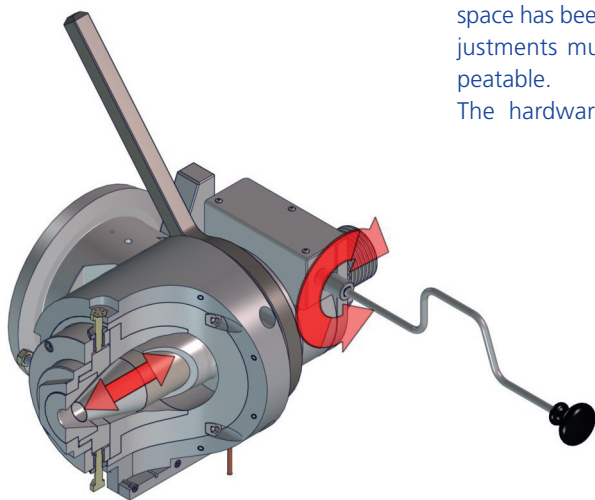

带有MAGS胶空间调节功能的新型500系列十字头是大多数现有NRM生产线的直接替代品,但这种十字头设计也可以适应任何挤压机设计或生产线布局。

添加了新设计的流入口通道后,可减少材料加工时产生的剪切力和热量,这有助于降低十字头的压力,使材料以更平衡和均匀流动的方式穿过十字头。

Guill提供的所有十字头都配有用于装配和拆卸的工具套件以及详细的操作员说明手册。Guill工程团队可随时协助用户实施和操作新型500系列十字头。

有关具有MAGS胶空间调节系统的新型Guill 500系列十字头的视频,请访问:

<https://youtu.be/jeNovmMtcBs>

### *New 500 Series Rubber/Silicone Extrusion Crosshead*

■ Guill Tool introduces the NEW 500 Series crosshead with MAGS gum space adjustment. The 500 Series is designed specifically for the flow characteristics and unique processing challenges of elastomeric compounds. One of the key features engineered by Guill on this new crosshead design is the mechanically assisted gum space (MAGS) adjustment system. This new method of gum space adjustment allows the operator to make an effortless adjustment from a single point using a common socket wrench. No more need to struggle with multiple nuts and bolts in order to adjust gum space, which leads to faster adjustments. The visual indicator on the core tube allows the operator to see how far the gum space has been moved, making those adjustments much more accurate and repeatable.

The hardware-free and patented cam

*Guill Series 500 crosshead with Mechanically Assisted Gum Space (MAGS) adjustment...specially designed for the flow characteristics of elastomeric compounds*

lock design of the NEW 500 Series from Guill means no time is wasted unbolting and re-securing fasteners for disassembly and re-assembly. Only half of a rotation of the cam nut is required to loosen and automatically extract the deflector from the head body, which is another time saver. Also, with no undercuts on the deflector, there are no material hang-ups when extracting the deflector, allowing for faster and easier cleaning and changeover.

The NEW 500 Series also features the latest Center-Stage concentricity adjustment system that significantly reduces pressure on the tooling, allowing easier and more precise concentricity adjustments without loosening the face bolts. Easy-Out inserts for the adjusting bolts also allow simple replacement of locked or damaged adjusting bolts, which further saves on repair and downtime.

Another innovative feature of this new rubber/silicone crosshead is a cast aluminum liquid-fed cooling sleeve that allows the user to switch out the cooling jacket in the event of a line obstruction, again reducing downtime compared to traditional integrated cooling systems.

The NEW 500 Series crosshead with MAGS gum space adjustment is a drop-in replacement on most existing NRM lines, however this crosshead design can also be adapted to fit any extruder design or line layout.

The addition of a newly designed flow inlet channel reduces the shear and heat that is generated as the materials are being processed. This leads to lower head pressures allowing the material to move through the head in a much more balanced and even flow.

All crossheads supplied by Guill are furnished with a tool kit for assembly and disassembly as well as a detailed operator's instruction manual. The engineering team at Guill will gladly assist users in the implementation and operation of the NEW 500 series crosshead.

For a video of the NEW Guill 500 Series crosshead with MAGS gum space adjustment, please go to:

<https://youtu.be/jeNovmMtcBs>

► **Guill Tool & Engineering**  
[www.guill.com](http://www.guill.com)



## 推出用于 NDT (无损检测) 的 X 射线操作软件系统

■ 继推出 ECO 产品和一系列新的定制高端解决方案后, VCxray (市场领导者 VisiConsult 的一个品牌) 在斯图加特的 Control 贸易展上推出了名为 x.OS 的 X 射线操作软件系统。

VisiConsult 最开始是基于开发用于工业 X 射线检测的创新软件方案。这一成功推动了机械和自动化领域的强劲增长, 并在解决各种客户需求和行业挑战方面积累了数十年的经验。VisiConsult 的 NDT 部门“VCxray”现在展示了一个创新的软件生态系统, 它既全面又可配置。这种模块化方法可以用作单独的离线应用程序, 也可以配置为互连的在线解决方案——以及介于两者之间几乎所有的情形。

系统操作员使用控制软件“VC.control”来运行或进行自动化操作。“VC.acquire”是一款用于 2D X 射线图像或 3D CT 扫描的多功能采集软件, 包括许多测量和图像处理功能。办公室的其他同事可以通过“VC.reco”直接评估和解释 CT 扫描的数据, 或使用“VC.review”以分析和评估 2D 图像。

所有这些工作内容都可以设置在不同的地方完成, 因为所有模块都在本地或通过云相互连接。检测的过程也可以在世界各地的不同系统之间共享。使用“VC.server”, 远程评估团队可以访问“VC.storage”中的所有数据。这也是归档数据以进行长期存储的地方。

质量经理或操作员可以使用车间的“VC.dashboard”了解不同检测项目的状态、每个零件的状态和任何其他 KPI。拥有全自动 X 射线检测系统的客户将受益于“VC.planner”模块, 主管可以轻松地为他们的系统开发或编辑检测程序和相关技术。他们可以离线执行此任务, 然后将新的检测程序发送到“VC.control”模块, 而不需要机器停机进行该操作。特别提出的是, 这些步骤不需要任何特殊的编程知识。

现在, 所有这一切都可以通过 VCxray 的新软件系统实现——一种可以针对任何情况进行配置的模块化方法。对于检测员来说, x.OS 通过所有部件的无缝集成提供最大的舒适度和效率。

### *X-ray Operating System for Non-Destructive Testing*

■ After the launch of the ECO line and a new collection of high-end customized solutions, VCxray (a division of the market leader VisiConsult) introduced a comprehensive X-ray Operating System named x.OS during the Control exhibition in Stuttgart, Germany.

The origins of VisiConsult were based on the development of innovative software solutions for industrial X-ray inspection. This success led to strong growth in the field of machinery and automation, and has since resulted in decades of experience in solving various customer needs and industry challenges. VisiConsult's NDT division “VCxray” now presents an innovative software ecosystem that is both comprehensive and configurable at the same time. This modular approach can be used as separate offline applications or can be configured as an interconnected online solution – and virtually everything in between.

System operators work with the control software “VC.control” to run or automate the X-ray system. “VC.acquire” is a versatile acquisition software for 2D X-ray images or 3D CT projections that includes many measurement and image processing features. Other colleagues in the of-

fice can evaluate and interpret the data directly via “VC.reco” for CT scans or “VC.review” for analysing and interpreting 2D images.

All of these tasks can be accomplished without the necessity of being in the same place because all of the modules are connected to each other locally or via the cloud. The inspection process can also be shared between different facilities worldwide. Using the “VC.server”, the remote evaluation team can access all data within the “VC.storage”. This is also the place where data is archived for long-term storage.

Quality Managers or operators can use the “VC.dashboard” on the shopfloor to get an overview about the status of the different inspection projects, the status of each part and any other KPIs. Customers with a fully automated X-ray inspection system will benefit from the “VC.planner” module where supervisors can easily develop or edit programs and techniques for their systems. They can perform this task offline, and then send the new inspection programs to the “VC.control” module without causing any machine downtime. It is important to note that these steps do not require any special programming knowledge.

All of this is now possible with the new software family from VCxray – a modular approach that can be configured for any situation. For inspectors, the x.OS offers maximum comfort and efficiency through seamless integration of all parts.

➡ VCxray  
VisiConsult X-ray Systems & Solutions  
GmbH  
<https://visiconsult.de>

## Guill推出往复式挤压头 – 自动挤压流程显著改变了挤压工艺

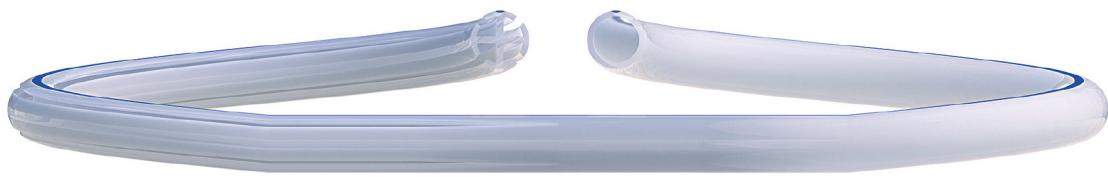

■ 全球挤压模具制造商Guill Tool推出了新型往复式挤压头。传统的头端和模具组件由线性往复式组件代替，该组件在给定长度内改变管材的外形。该工艺在整个单挤压过程中重复，无需中断。切割能力外加挤出速度将成品切割成一定的长度。

这降低了成本和价值流活动，而且提高了质量。生产成品只需一次挤压操作，而不是多次挤压操作，也无需更换工具或手动装配操作来连接不同形状的管材。Guill推出的新型往复式挤压头消除了装配操作，还消除了流程中库存。因此，无需储存装配、订单履单和成品补给所需的各种形状的管材和接头。

此外，往复式挤压头消除了连接件，允许准时生产和按订单生产产品。最后，它减少了从接收订单到发货的总运行时间。

如需了解更多信息，请联系：

### *Reciprocating Head Introduced – Automated Extrusion Process Drastically Changes the Extruded Profile*

■ Guill Tool, a global manufacturer of extrusion tooling, has released its new reciprocating head. The traditional tip and

die assembly is replaced with a linear reciprocating assembly that changes the tube's profile within a given length. This process is repeated throughout a single extrusion run without interruptions. Cutting capability, in association with the extrusion speed, cuts the finished product to length.

While cost and value stream activities are reduced, quality is improved. Only one extrusion run is needed to produce a finished product, as opposed to multiple extrusion runs with tooling changes along with a manual assembly operation to connect different tubing shapes. Guill's new reciprocating head eliminates an assembly operation. It also eliminates in-process inventory. Thus, there is no need for storage of various tubing shapes and connectors needed for assembly, fulfillment of orders and replenishment of finished goods.

Furthermore, the reciprocating head eliminates a connecting piece, allows JIT production and products made-to-order. Lastly, it reduces total run time from receiving the order to shipping.

For more information, please contact:

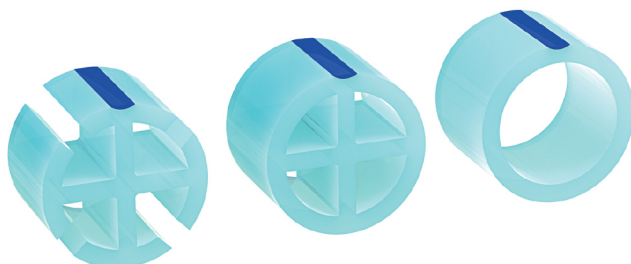
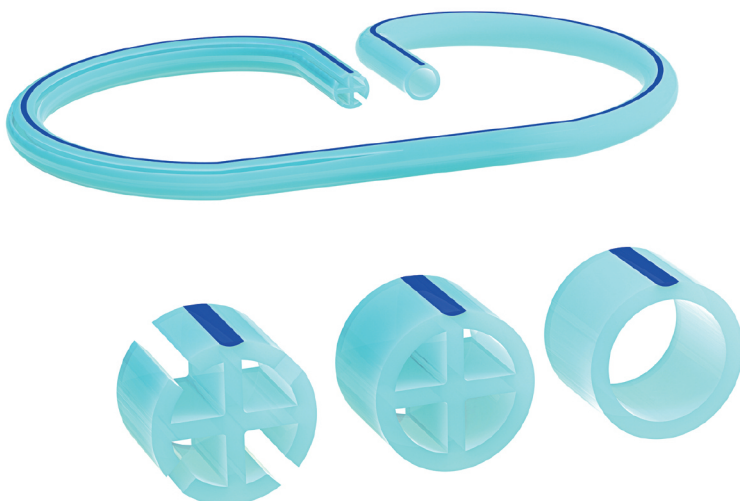

## 片材制造商通过改造使其挤压生产线适应未来的需要

■ MP3，这是一家属于I.L.P.A.-控股的意大利公司。他们在Valsamoggia工厂的专业工厂生产高品质的ABS，ABS / PMMA和PS板材，用于家具和建筑行业以及车辆，热卫生等的热成型技术部件。

除了闭环回收所有内部PET废料外，MP3现在还专注于增加最终产品中其他热塑性塑料，ABS或PS的回收内部废料的数量。

五年前，MP3已经用Gneuss SFXmagnus装置替换了他们现有的三个换网器，因为以前他们无法在不影响产品质量的情况下使用高百分比的回收材料。该板材生产线由一台主挤出机和两台共挤机组组成。PS、ABS和PMMA在此生产线上进行处理，每天最多可更换三次颜色。由于用Gneuss系统取代了原先的换网器，即使在高污染负荷下，它们也能够增加高达50%的回收料，而不会造成工艺干扰或质量问题。

SFXmagnus换网器的特点是其整体外部尺寸具有非常大的有效过滤区域，这意味着它特别适合对现有生产线进行改造。与所有Gneuss旋转过滤系统一样，滤网片可以在正常生产过程中进行更换，而不会出现压力峰值或其他干扰和波动。可以确保出色、一致的板材表面质量，这代表了MP3的竞争优势。2020年，MP3用三个SFXmagnus旋转过滤系统改造了另一条生产线，并在2022年初用另外三个同样的装置改造了另一条生产线。

### Sheet Manufacturer Future Proofs its Extrusion Lines by Retrofitting

■ MP3, an Italian company belongs to I.L.P.A.- Holding. Their specialised factory in Valsamoggia factory manufactures high quality ABS, ABS/PMMA and PS sheet both for the furnitures and building industry and for thermoformed technical parts for vehicles, thermo sanitary etc. In addition to the closed loop recycling of all internal PET scrap, MP3 now focuses



MP3的片材挤出生产线，具有三个压力和工艺恒定的Gneuss SFXmagnus熔体过滤器

### Sheet extrusion line at MP3 with three pressure- and process-constant Gneuss SFXmagnus melt filters

on increasing the amount of recycled internal scrap from other thermoplastics, ABS or PS in their final products.

Five years ago, MP3 already replaced three of their existing screen changers with Gneuss SFXmagnus units on one of their sheet lines as previously they had been unable to use high percentages of recycled material without compromising the product quality. This sheet line consists of one main extruder and two co-extruders. PS, ABS and PMMA are processed on this line, with up to three colour changes daily. Thanks to the replacement of the screen changers with Gneuss systems, they were able to add up to 50 % regrind without either process disturbances or quality issues, even with a high contamination load.

The SFXmagnus Screen Changer is cha-

racterised by its large active filtration area for its overall external dimensions which means that it is especially well suited for retrofitting to existing lines. As with all the Gneuss Rotary Filtration Systems, the screenpacks can be changed during normal production, without pressure spikes or other disturbances. Consistent sheet surface quality can be ensured and this represents a competitive advantage for MP3.

In 2020, MP3 retrofitted another line with three SFXmagnus Rotary Filtration Systems and a further line was retrofitted with another three units early in 2022.

➔ Gneuß Kunststofftechnik GmbH  
www.gneuss.de

# 充分利用您的挤出模具

## Getting the Most from Your Extrusion Tooling

作者：Glen Guillemette，总裁

模具维护可以提高医用管材应用的挤出效率，提升质量及整体生产力。

By Glen Guillemette,  
President Guill Tool & Engineering

*Tooling maintenance improves extrusion efficiency, enhances quality and boosts overall productivity for your medical tubing applications.*

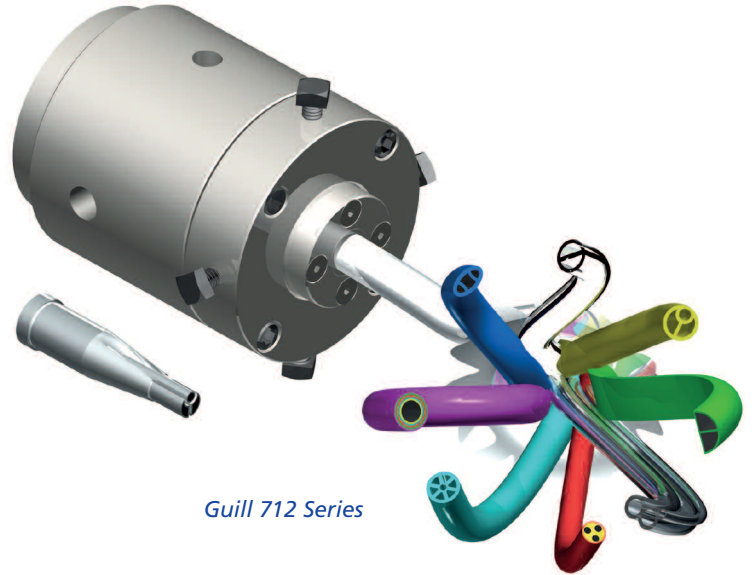

Guill 712 Series

通过使用最先进的生产设备和工艺，当今多腔和多层医用管材的加工公差可以降低至最低。需要注意的重要一点是，模具的任何误差都可能在成品中被放大。清洁的零件，尤其是密封和定位表面，是保证产品性能和优质成品的关键。这些表面在制造过程中获得的关注最多，并且是确保整个管材一致性的控制表面。请记住，哪怕直径仅千分之几英寸的灰尘也会对精密机械加工的对位产生影响。人的发径约为0.003英寸（0.08毫米），由于高质量模具中有许多这样的表面，清洁度至关重要。

检查模具是否有任何变形也很重要。毛刺、划痕和刮伤通常是由粗心搬运和/或存放设备造成的。双层和三层挤出头的维护难度更高。密封和定心表面的数量倍增，从而会放大模具不洁净的影响。在更换时，您可以先拆卸挤出头，以便更换化合物和/或头端和模具。异物通常会在此时进入，您必须彻底清除残留物质。由于处理不当和储存技术不佳，通常会在此阶段给模具造成机械损坏。这些零件是高精度零件，但同时也笨重、巨大，难以徒手拆卸。建议使用专门配备用于挤出头维护的专用工作车。该工作车配备有备件和硬件，建议购买和使用，特别是考虑到良好维护的模具可帮助您降低成本。您应当注意以下事项：1.) 使用柔软、干净、可恢复的工作表面，保持工作区域干净整洁 2.) 使用软钳口的钳子，例如铜制钳口 3.) 使用特殊设备，如刀尖清除工具等 4.) 标准工具包括扳手、软面锤等 5.) 常备柔软干净的抹布 6.) 使用瓶装喷雾清洁剂 7.) 使用工具供应商建议的妥善管理和储存的备件 8.) 将设备维修/维护手册保存在方便查阅的地方 9.) 使用小型平板，以提供平坦表面 10.) 使用一套适当的量规和顶针进行初始工具位置调整 11.) 确保您拥有所有适当的举升辅助工具，包括高架起重机、液压升降机等。

在大多数情况下，挤出头和模具将仍然处于高温，因此搬运时需要戴配衬里的手套。如今，管路制造商需要与全球的公司竞争。要想成为一家成功、盈利的公司，质量和效率至关重要。在挤出领域尤其如此，因为材料成本通常远高于人工成本。就像一辆身陷凹坑的赛车一样，许多挤出机由于模具不良或损坏而处于闲置状态，并且需要过多的维护时间。管理费用会迅速上升，最终造成亏损。有些挤出机能够快速启动，但只是在制造废料，而另一些挤出机制造的产品超大，无法达到最小容差的要求。10%到20%的材料被浪费，占产品成本的50%到90%。模具供应商在竭尽全力将头端和模具加工到确定的规格，以确保完美的同心度和对位。然后，材料将作为成品的一部分被安放到适当的位置。

### 了解维护程序

例1：在这个例子中，未能正确居中的模具导致计算出的超容差面积达到0.059平方英寸（38平方毫米）。比较这两个表面积时，计算出的材料浪费率占成品的11.8%。公式为：壁厚% = 最小壁厚 / 最大壁厚 × 100。例2：或者，如果壁厚%可以从80%增加到95%，则可以节约大约12%的总成本。当然，成本节约情况会因设计而异。处理沉重和笨重部件时，请寻求帮助。表面和边缘很硬，有点脆，因此零件坠落或相互碰撞可能导致损坏。将模具妥善存放在干燥清洁的地方——最好是每个模具都有专门的存放位置。这些区域应该有柔软的表面，每个器械在清洁后均应盖好。另外，模具应该彼此隔离，以免它们彼此接触。模具和所有器械在储存前应彻底清洁。

拆卸模具时，必须使用专用工具来帮助拆卸。您的供应商可以提供这些专用工具。如果他们不能提供专用工具，请联系

系信誉良好的工具厂商购买替换件。这些工具的成本很容易就被潜在的损坏所抵消，而损坏通常是由不适当的设备（如锤子）和位置偏移造成的。请遵循操作手册中的说明。个别模具可能会有特殊要求，所以，如果有任何不清楚的地方，请联系您的供应商。您的供应商明白，最佳性能取决于正确的保养和维护。这里提供一些有用的提示：1.) 请在设备还热的时候清洁设备，因为此时更容易清除残留物。一次应仅拆卸和清洁一个模具，这样可以保持模具具有较高的温度。2.) 清洁双成分十字头时（塑料和橡胶），先清洁塑料模具，然后再清洁橡胶模具。3.) 切勿使用刮刀或螺丝刀等钢制工具，因为这些工具可能划伤和损坏模具。4.) 不要使用明火，因为这会产生过多的热量，特别是在较薄的部分，从而影响部件的硬度、同心度和容差。推荐的清洁工具和材料包括：a.) 黄铜钳子，用于抓lao材料并协助拉动 b.) 不同宽度的黄铜刮刀，用于清洁平坦的暴露表面 c.) 黄铜丝管刷，直径从1/16英寸到1英寸，增量为1/16英寸（适用于清洁孔和凹槽）d.) 黄铜棒—不同直径的黄铜棒适用于将材料推出流孔 e.) 铜丝网，用于清洁和抛光暴露的圆形或圆锥形表面 f.) 铜刀，用于清除凹槽和其他难触及区域的残留物。另外，抛光化合物用于修复抛光表面 g.) 压缩空气可以更有效地吹除塑料，同时也有助于去除橡胶。小心不要用压缩空气将残留物压入凹槽 h.) 清洁剂也会有帮助，请记住使用新的干净抹布（旧抹布通常嵌有金属屑，可能会划伤抛光表面）i.) 清洁烤箱——仅限于塑料部件。遵循制造商的建议。如果没有指定温度，不要超过850华氏度（454摄氏度）。不要淬火冷却模具，这可能会影响模具的硬度、同心度和容差。j.) 清洗化合物—几种清洗化合物可以用来清洗挤出机螺杆/筒体残留的聚合物和橡胶化合物 清除过量材料以实现最佳的加工效率 清洁的零件对挤出模具的性能和加工质量至关重要。密封和定位表面尤其如此，因为它们控制生产过程的一致性。对于工具的一般维护，在储存或工具转换之前，彻底清洁和清除多余材料可确保生产具有精准容差成品所需的精密加工对位。设备应在温度仍然很高时清洁，因为会更容易清除残留的聚合物和橡胶。加热工具时请务必遵守所有MSDS建议。请戴防热手套，以保护手部因接触加热工具表面而受伤。建议使用黄铜刮刀和黄铜或铜绒清洁布，因为它们足够柔软，不会划伤表面。

让清洁模具更容易 取出模具的最快方法是利用挤出机的压力将其推出。使用空气压缩机和黄铜钳清洁模具体部，以便材料冷却，从而增加熔体强度，使其成为一体，而不会成为难以去除的弹性胶状物质。使用压缩空气和黄铜钳清洁体部进料口，以同时冷却和去除进料口上多余的残留物。完成此步骤后，用圆形黄铜刷刷表面，以抛光表面。使用黄铜刷仔细清洁2英寸（51毫米）法兰接合器的流动区域。

检查所有表面是否有任何不平整的地方，如毛刺和划痕，因为在重新组装挤出头前必须修复上述现象。大多数制造商建议使用手工抛光石来去除有害的毛刺。使用抛光石清洁后，必要时使用600目砂布进行轻微磨光，但不要打磨本应锐利的边缘。平坦的密封表面也可以用抛光石清洁，然后用600目砂布磨光。将布放在干净、平整的表面上，最好是平板上，然后用手以画圆的方式施加摩擦，直至相应区域干净平整。这些部件应全部为硬化钢合金，不会因使用上述方法而受到不利影响。铬镍铁合金、蒙乃尔合金和哈氏合金通常没有经过热处理，因此需要特殊的养护和处理以避免损坏。

### 不要忽视维修

模具保养有助于确保高质量的挤出产品，即符合尺寸规格、保持指定的最小容差且经济实惠的产品。沾污、未经适当维护和未经妥善调整的模具会导致施用过多的化合物，从而使维持最小厚度容差变得更复杂。过多的材料会导致不必要的成本支出，这会直接影响贵公司的盈利能力以及客户关系。重要的最后一步—重新组装使用专用工具车，按照制造商的说明进行重新组装。在安装之前，请使用干净的抹布对每个部件进行最后的擦拭。必须清除哪怕是极微量的砂砾、污垢和残留物质。对于沉重和笨重部件，使用机械或请他人帮助，以避免不必要的事故。如果需要，在所有紧固件上重涂一次防卡化合物。按照制造商推荐的规格以及建议的顺序拧紧紧固件。手册应当规定了这种紧固顺序，通常以星形图的方式呈现。逐渐拧紧紧固件，直到达到适当的扭矩，以防止模具变形。模具制造商的一个主要目标是尽可能在挤出物刚刚从模具的分布毛细管中被挤出时，快速、准确地在模具的主要部分形成同心圆锥体。设计和制造适当的模具在挤出物入口点附近具有均匀分布，但是一旦模具被调整，这种分布就会受到影响，从而使挤出物向一侧偏移。在主要区域形成一个偏心圆锥体，并且在该过程中仅在一个点存在同心圆锥体，而不是形成体积逐渐减小的平滑连续的流动路径。正确制造和对位精确的挤出头以及良好维护的模具只需很少的调整甚至不需要调整。不必要的模具调整的另一个不利影响是不平衡流动对挤出物产生压力。最终结果是最终产品保留了所产生的这种不平衡，并且发生了不可预测的模口膨胀。

By utilizing state-of-the-art production equipment and processes, machining tolerances are held extremely close on today's multi-lumen and multi-layer medical tubing. It is important to note that any misalignment of the tools may be exaggerated in the final product output. Clean parts, especially with sealing and locating surfaces, are key to product performance and successful end products. These surfaces receive the most care and attention during manufacturing and are the control surfaces that ensure uniformity throughout the tubing.

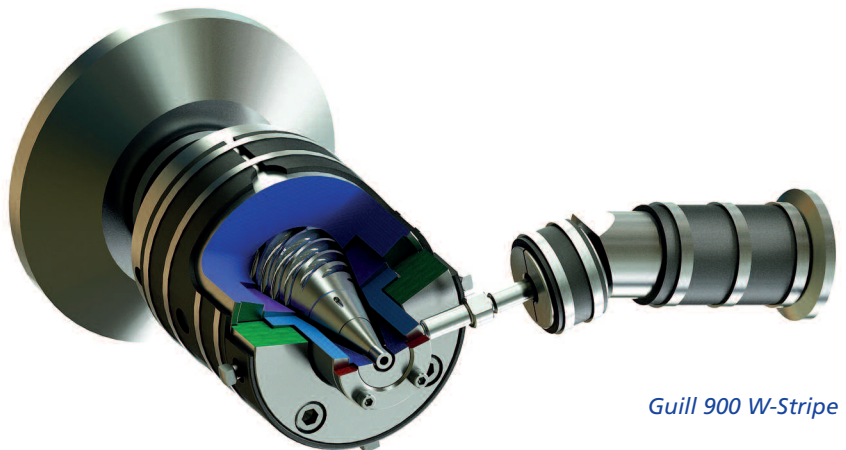

Guill 900 W-Stripe

Remember, precision-machined alignments are affected by even a speck of dirt measuring only a few thousandths of an inch. A human hair is about 0.003" (0.08 mm), and since there are many such surfaces in a quality tool, cleanliness is critical. Checking of the tools for any deformities is also important. Burrs, scratches and scrapes are usually a result of careless handling and/or storage of equipment. Double and triple-layer extrusion heads pose an even greater challenge for maintenance. The number of sealing and centering surfaces multiplies and can magnify the results of dirty tools. During changeovers, the head may be disassembled in order to change compounds and/or tips and dies. Foreign matter is usually introduced at this point and residual materials must be thoroughly removed. Physical tool damage often occurs during this phase, due to mishandling and poor storage techniques. These are highly precise parts, but can also be heavy and bulky to remove by hand. Use of a dedicated work cart exclusively reserved and equipped for extruder head maintenance is recommended. This cart along with a supply of spare components and hardware is easily justified, especially when examining the potential cost savings that result from well-maintained tools. The following should be considered: 1.) Maintain a clean, organized work area with soft and clean renewable work surfaces; 2.) Use a vise with soft jaws, such as copper; 3.) Use special equipment, such as tip removal tools, etc.; 4.) Standard tools include wrenches, soft-faced hammers, etc.; 5.) Maintain a supply of soft, clean rags; 6.) Use cleaning solutions in spray bottle; 7.) Use spare parts as suggested by your tooling supplier, properly organized and stored; 8.) Keep handy your equipment's repair/maintenance manual; 9.) Have a small surface plate to provide a true flat surface; 10.) Use a set of appropriate gauge and tip pins for initial tool location adjustment; 11.) Make sure you have all the proper lifting aids available, including overhead hoists, hydraulic lifts, etc. In most situations, the head and tooling will still be at elevated temperatures, therefore lined gloves are needed when handling.

Today, tubing manufacturers compete with companies all over the world. To be a successful and profitable company, quality and efficiency are essential. This is especially true in extrusion, where material costs are usually much higher than labor costs.

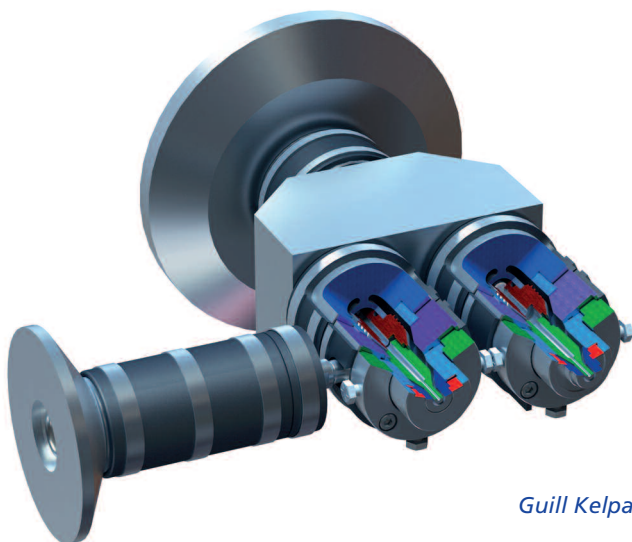

Guill Kelpac

Like a racing car stuck in the pit, many extruders sit idle because of poor or damaged tooling, plus excess maintenance time. Overhead costs add up and losing money is the result. Some start up quickly and make scrap, whereas others start up and run a product oversized to hold minimum tolerance. They waste 10% to 20% of the material, which can run from 50% to 90% of the product cost. The tooling supplier goes to great lengths so that tips and dies are machined to a determined specification, ensuring perfect concentricity and alignment. The material is then distributed in the proper location as part of the finished product.

#### *Understanding Maintenance Procedures*

**Example 1:** In this example, with an improperly centered tool, a calculated out-of-tolerance area of 0.059 in<sup>2</sup> (38 mm<sup>2</sup>) was derived. When the two surface areas were compared, the calculated material waste was 11.8% of the finished product. The formula is % wall = min. wall thickness, max. wall thickness X 100. **Example 2:** Alternatively, if the % wall can be increased from 80 to 95%, a savings of about 12% of total cost can result. Savings will vary depending on the designs, of course. Get help for heavy parts and awkward situations. Surfaces and edges are hard and therefore somewhat brittle, so dropping a part or striking parts together can result in damage. Store your tools properly in a dry, clean area – a dedicated spot for each tool is best. These areas should have soft surfaces and each instrument should be covered after cleaning. Also, tools should be segregated so that they do not come into contact with each other. And tools and all instruments should be cleaned thoroughly before storage.

For disassembly of tools, it is imperative to use purpose-built tooling to facilitate disassembly. These should be available from your supplier. If they are not, consult with a reputable tooling house for replacements. The cost of these tools is easily offset by potential damages, frequently caused by improper equipment such as hammers and drifts. Follow the guidelines outlined in your operator's manual. Individual tools may have specific recommendations, so contact your supplier if anything is unclear. Your supplier understands that optimum performance relies on proper care and maintenance. Here are some useful tips: 1.) Clean your equipment while it is still hot as the residue is easier to remove. It helps to remove and clean one piece of tooling at a time in order to maintain elevated temperatures. 2.) When cleaning a dual compound crosshead, (plastic and rubber) clean the plastic tooling first; the rubber second. 3.) Never use steel tools such as scrapers or screwdrivers because these can scratch and mar the tooling. 4.) Do not use open flames because this generates excessive heat especially in thin sections, which can affect hardness, concentricity and tolerances of components. Recommended cleaning tools and materials include: a.) Brass pliers to grip material and aid in pulling; b.) Brass scrapers available in different widths for cleaning flat exposed surfaces; c.) Brass bristle tube brushes that are available in diameters from 1/16" to 1" in 1/16" increments (ideal for cleaning holes and recesses); d.) Brass rods – different diameter rods are good for pushing material out of flow holes; e.) Copper gauze for cleaning and polishing exposed round or conical surfaces; f.) Copper knives for removing residue from recesses and other hard-to-reach areas. Also, polishing compound restores polished surfaces; g.) Compressed air, which is more effective for relea-

sing plastic, but also aids in rubber removal. Be careful not to force debris into recesses with compressed air; h.) Cleaning solutions may be useful, so remember to use fresh, clean rags (used rags often have metal chips embedded in them, which may scratch polished surfaces); i.) Cleaning oven – for plastic only. Follow manufacturer's recommendations. If no temperatures are specified do not exceed 850 degrees F (454 degrees C). Don't quench tooling to cool, as this could affect tooling hardness, concentricity and tolerances. j.) Purging compounds – several are offered to purge the extruder screw/barrel of residual polymer and rubber compounds.

### **Removing Excess Material for Optimum Machining Efficiency**

Clean parts are critical to extrusion tooling performance and quality manufacturing. This is especially true for the sealing and locating surfaces – that control uniformity of the production process. For general maintenance of the tools, before storage or tooling changeover, a thorough cleaning and removal of the excess material assures the precision machining alignments required to produce end products to the precise tolerances. Equipment should be cleaned while it is still hot, since residual polymer and rubber will be easier to remove. Be sure to follow all MSDS recommendations when heating the tooling. Thermal gloves are used to protect the hands from the heated tooling surfaces. A brass scraper, as well as a brass or copper wool cleaning cloth are recommended because they are soft enough not to scratch the surface.

**Make Tool Cleaning Easier** The quickest way to remove the die is to employ the pressure of the extruder to push it out. Clean the body by using an air compressor and brass pliers so that the material cools down which increases the melt strength, making it into one-lump versus an elastic, gummy-like substance that is harder to remove. Cleaning the body feed port using compressed air and brass pliers to simultaneously cool and remove the excess residue from the feed ports. This procedure is followed by brushing with a round brass brush that polishes the surface. The flow area of the 2" (51 mm) flange adapter should be cleaned by carefully using a brass brush.

Examine all surfaces for any irregularities such as burrs and scratches since these must be repaired before the head is reassembled. Most manufacturers recommend using a hand polishing stone to remove the offending burr. Follow stoning with a light application of 600-grit emery cloth if necessary, but avoid rounding edges that are intended to be sharp. Flat sealing surfaces can also be cleaned using a stone, followed by a 600-grit emery cloth. Place the cloth on a clean, flat surface, preferably a surface plate, then apply friction in a circular hand motion until the area is clean and even. The parts in question should all be hardened steel alloys and will not be adversely affected using these methods. Inconel, monel and Hastalloy® are typically not heat-treated, requiring special care and handling to avoid any damage.

### **Don't Overlook Repairs**

Tooling maintenance helps ensure a quality extruded product – one that meets dimensional specifications, maintains the speci-

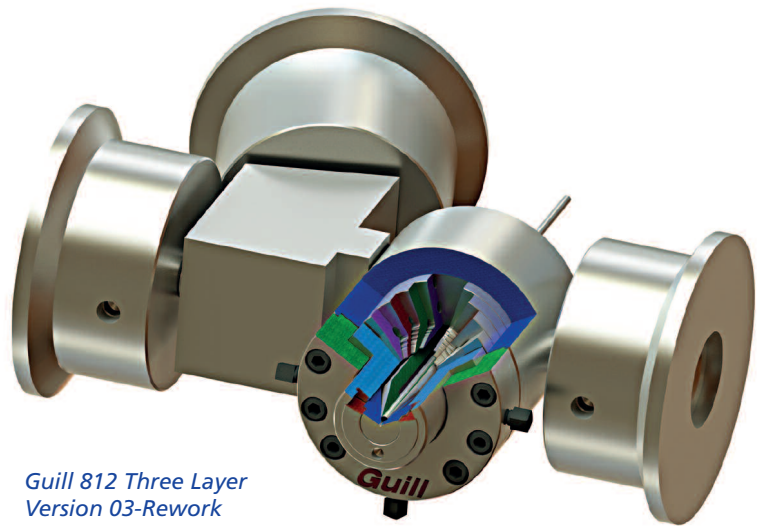

*Guill 812 Three Layer  
Version 03-Rework*

fied minimum tolerance and is economically produced. Dirty, neglected and improperly adjusted tools contribute to excessive compound applications, which in turn complicate maintenance of minimum thickness tolerance. Excess material results in unnecessary costs and these directly affect the profitability of your company and the relationships with your customers.

### **The Important Final Step – Reassembly**

Working from your dedicated tool cart, follow the manufacturer's instructions for reassembly. Give each component a final wipe down with a clean rag before installing. Even the smallest amount of grit, dirt and residual material must always be removed. Use mechanical or manual assistance for heavy and awkward components to avoid unnecessary mishaps. Reapply anti seize compound to all fasteners if required. Tighten fasteners to manufacturer's recommended specifications as well as in the recommended sequence. This fastening sequence should be specified in the manual and is generally in a star pattern. Tighten gradually until the proper torque is achieved to prevent distortion of the tooling. One of a die manufacturer's main goals is to form a concentric cone as quickly and accurately as possible in the primary section of the die – when the extrudate first emerges from the die's distribution capillaries. A properly designed and manufactured die has even distribution close to the extrudate entrance point, but this effort is negated once the die is adjusted, shifting the extrudate off to one side. An eccentric cone is formed in the primary area, and a concentric cone exists at only one point in the process, rather than a smooth, continuous flow path with decreasing volume. A properly manufactured and aligned extruded head, along with well-maintained tooling should require little or no adjustment.

Another adverse affect of unnecessary die adjustment is the stress introduced to the extrudate caused by unbalanced flow. The net effect is the final product retains memory of this imbalance and unpredictable die swell occurs.

► **Guill Tool & Engineering**  
10 Pike Street, West Warwick, RI 02893, USA  
[www.guill.com](http://www.guill.com)

# Multi-Touch压光辊生产塑料地板覆盖物有利于足部健康

## *Sheet Extrusion – Case Study: Multi-Touch Roll Stack is Good for our Feet*

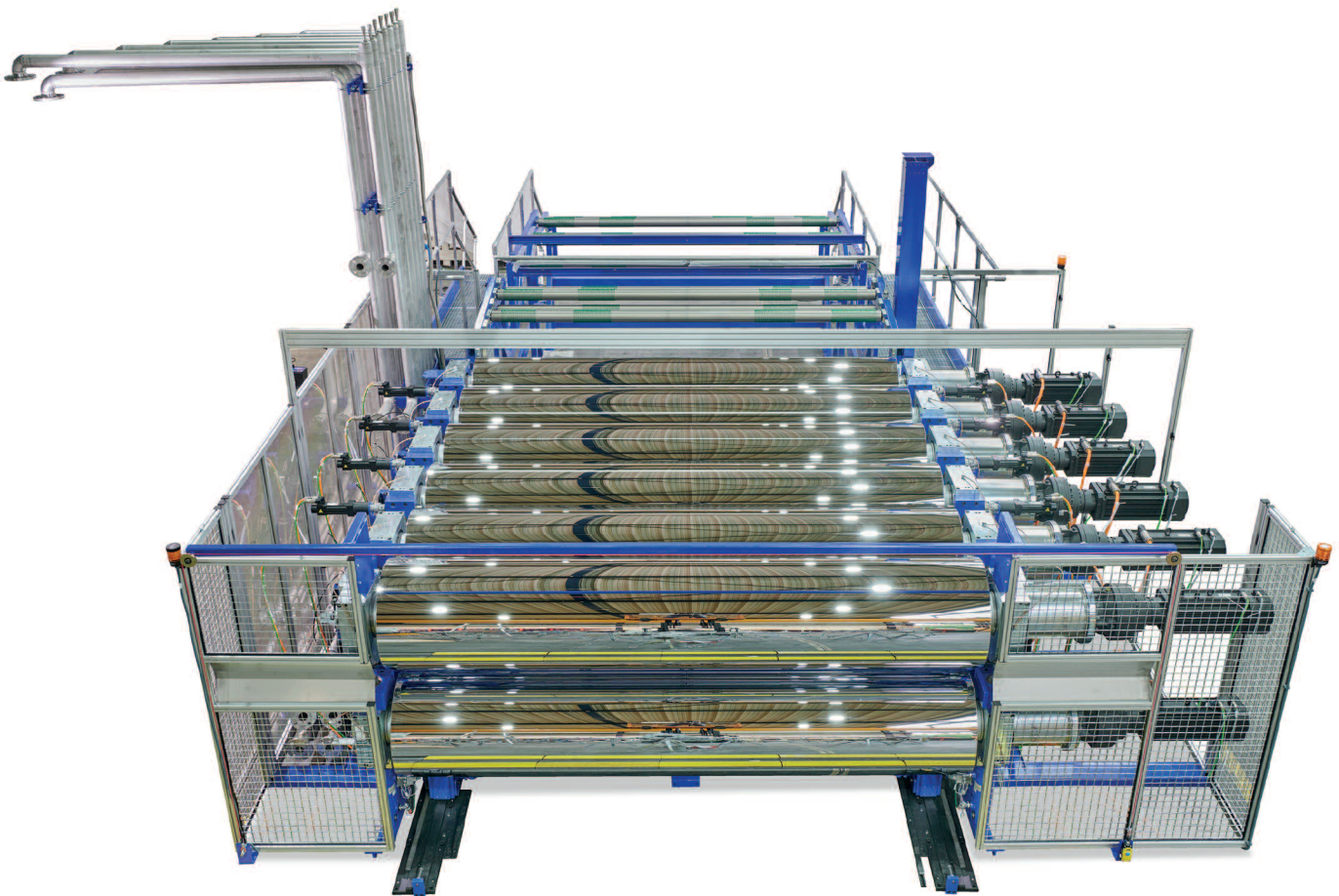

德国CLASSEN康麦森公司提供用于健康生活的可持续CERAMIN材料塑料地板，在一条配置Multi-Touch 压光辊的挤出生产整线上投产，该生产线来自德国巴顿菲尔辛辛那提公司。总部位于德国柏林附近的凯撒斯埃施(Kaisersesch)的CLASSEN康麦森公司是这些具有“蓝色天使”质量标志，创新的无PVC地板覆盖物的发明者和制造商。

*The sustainable plastic floor boards made of CERAMIN by CLASSEN for healthy living are recently being produced on a complete extrusion line with a Multi-Touch roll stack from battenfeld-cincinnati Germany GmbH. CLASSEN, based in Kaisersesch, Germany, is the inventor and manufacturer of these innovative, PVC-free floor coverings with the “Blue Angel” seal of quality.*



CERAMIN 地板以聚丙烯为基础材料制成。具有无污染，100%可回收特性，并使用回收材料生产。基于 CERAMIN 地板覆盖物的坚固耐用，可为私人住宅以及公共和工业建筑提供塑料地板的所有优势。地板尺寸稳定、耐磨、防水、触感温暖且耐紫外线。

传统的基于软PVC的塑料地板具有可回收性差的缺点，并且由于其污染成分如氯、稳定剂、邻苯二甲酸酯和其他增塑剂而受到批评。这就是 CLASSEN 康麦森公司开发 CERAMIN 作为无 PVC 地板覆盖物载体板材料的原因。具体来说，Ceramin 板由 60% 的天然矿物填充材料、39% 的聚丙烯基聚合物和 1% 的环保和健康相容性添加剂组成。CLASSEN 塑料地板中的载体板覆盖有保护性底涂层以及底漆和装饰层，具有柔软触感的表面处理，行走上面，脚部倍感舒适。

在主要部件（即2至5mm厚的板材）的生产过程中，板材必须绝对均匀平整、表面干净无波纹，并符合极窄的强度公差范围，这当然是至关重要的。这对于进一步加工以及以后用作地板覆盖物很重要。在 battenfeld-cincinnati 生产线中，具有高填料含量的 CERAMIN 板的无可挑剔的质量标准主要归功于 Multi-Touch 压光辊。由于板和辊之间的持续接触，该设备确保了校准和冷却的完美条件。

现场安装在 CLASSEN 公司的两条生产线配备了来自德国纽伦堡的 Leistritz 挤出设备有限公司的双螺杆挤出机，它们与计量单元相连，可确保每小时高达 8 吨熔体的完美均化。在下游，它们连接到一个自动平模头，熔体膜通过该模头入 2.6 m 宽的 Multi-Touch 压光辊。接着，预校准在两个压光辊中进行，然后板材通过多个辊进行重新校准。这样，板材在相当长的一段时间内与辊面连续接触，生产出具有完美的尺寸稳定性和出色的视觉属性。牵引机后是尺寸切割机。生产整线由集成在客户的 PDA 系统中的 BCtouch UX 控制系统操控。在第二个处理步骤中，如上所述，用不同的膜层作为装饰层，覆膜在板材上，从而在大范围、多样化的图案中选择装饰。

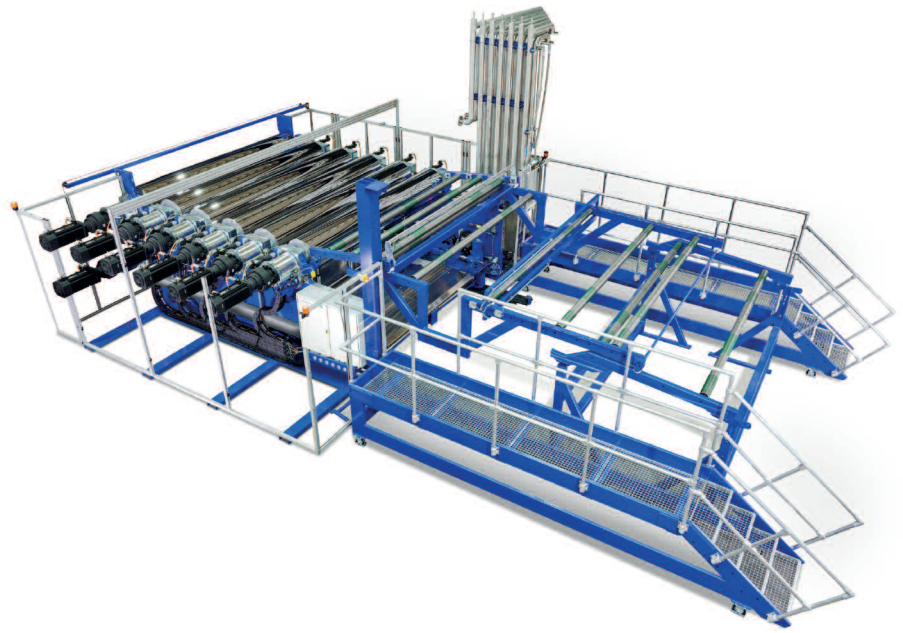

health-compatible additives. The carrier boards in plastic floors from CLASSEN are covered with a protective undercoat as well as a primer and decorative layer with a soft-touch surface finish to make human feet feel comfortable.

In the production of the main component, that is, the 2-to-5-mm-thick board, it is of course vital that the board is absolutely even, has a clean, ripple-free surface and complies with extremely narrow strength tolerances. This is important for further processing as well as for its later use as floor covering. In the battenfeld-cincinnati line, the impeccable quality standard of the CERAMIN board with high filler content is primarily due to the Multi-Touch roll stack. Due to continuous contact between the board and the rolls, this device ensures perfect conditions for calibration and cooling.

The two lines now installed at CLASSEN are equipped with two twin screw extruders from Leistritz Extrusion GmbH, based in Nuremberg/Germany, which are connected to the dosing unit and ensure perfect homogenizing of up to 8 t of melt per hour. Downstream, these are connected to an auto-matic flat-sheet die, through which the melt film proceeds into the 2.6 m-wide Multi-Touch roll stack. Here, pre-calibration takes place in a two-roll stack, before the board passes through several more rolls for recalibration. In this way, the surface of the board is continuously in contact with the roll surfaces over a considerable period of time, with the result of perfect di-mensional stability and excellent visual attributes. The haul-off is followed by a size cutter. The complete line is controlled by BCtouch UX, which is integrated in the customer's PDA system. In a second processing step, the boards are laminated as described above with the various layers of film and thus provided with a decoration chosen from a large, diversified range of patterns.

CERAMIN is produced from polypropylene as base material. It is pollutant-free, 100 per cent recyclable and produced with recycled materials. The sturdy, durable floor coverings based on CERAMIN offer all the advantages of plastic flooring for private residences as well as for public and industrial buildings. The floors are dimensionally stable, abrasion- and water-proof, warm to the touch and resistant to UV light.

Conventional plastic floors based on soft PVC have the disadvantage of poor recyclability and are subject to criticism due to their pollutive ingredients such as chlorine, stabilizers, phthalates and other plasticizers. This is why the CLASSEN Group has developed CERAMIN as a material for the carrier boards of PVC-free floor coverings. In detail, CERAMIN boards consist to 60% of a natural mineral filler material, to 39% of polymers based on polypropylene, and to 1% of environmentally friendly and

► **battenfeld-cincinnati Germany GmbH**  
Bad Oeynhausen, Germany  
[www.battenfeld-cincinnati.com](http://www.battenfeld-cincinnati.com)

► **CLASSEN**  
[www.classengroup.com](http://www.classengroup.com)

# EFSA合规工艺从PET回收物生产食品级安全片材

## Extrusion Coating: EFSA-Compliant Process Produces Food-Safe Sheet from PET Recyclate

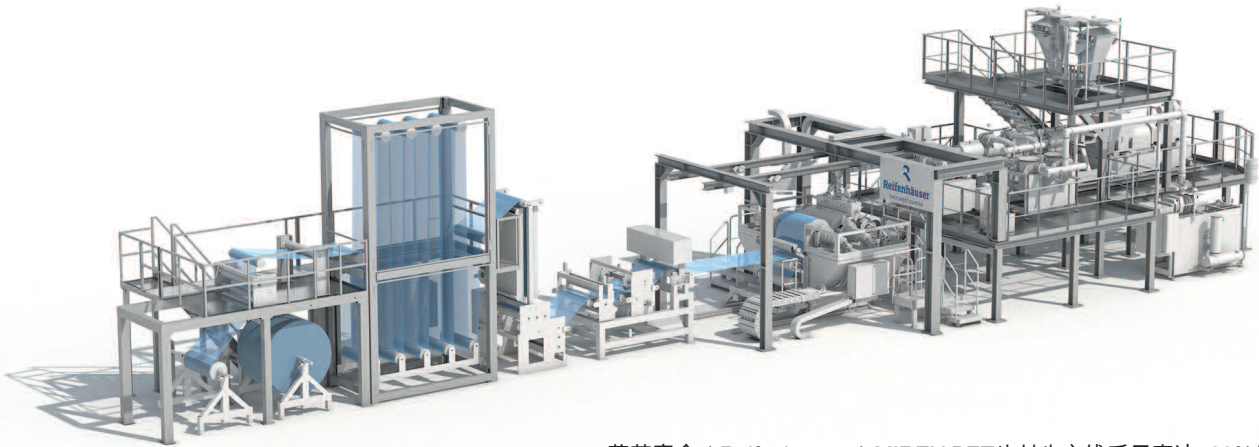

莱芬豪舍 (Reifenhäuser) MIREX PET片材生产线采用高达100%的PET瓶片生产可持续PET塑料瓶碎片，用于直接接触食品（符合欧盟食品安全局 (EFSA) 标准）（照片：莱芬豪舍）

*Reifenhäuser MIREX PET sheet lines produce sustainable PET sheet from up to 100% PET bottle flakes for direct food contact (in compliance with EFSA) (Photo: Reifenhäuser)*

莱芬豪舍流延片材涂布公司 (Reifenhäuser Cast Sheet Coating) ——莱芬豪舍集团专门从事流延膜、片材挤出和挤出涂层生产线的业务部门——开发了一种特别高效的生产工艺，可将PET回收物直接加工成食品级安全片材，而无需上游干燥工艺。

*Reifenhäuser Cast Sheet Coating – the Reifenhäuser Group's business unit specializing in cast film, sheet extrusion, and extrusion coating lines – has developed a particularly efficient production process that allows PET recyclate to be processed directly into food-safe sheet without an upstream drying process.*

如果回收材料与食品直接接触，则需要欧盟食品安全局 (EFSA) 的特殊认证。到目前为止，这种类型的食品包装用片材的生产一直非常费力又复杂。莱芬豪舍MIREX PET生产线现在简化了处理机的任务。通过使用同向旋转双螺杆挤出机和专门开发的高性能真空系统，经认证的工艺允许直接处理PET回收材料，而无需预处理和预干燥——这是通常需要的工艺。处理机可以节省额外线路组件的投资，避免额外的能源和维护成本。它还允许快速改变材料和产品，例如，从回收再生料PCR) 到工业用后废料 (PIR) 或到原生聚酯粒。制成品，如肉类托盘，符合极高的卫生标准，符合欧盟食品安全局标准，可直接与食品接触使用。

莱芬豪舍流延膜、片材挤出和挤出涂层在主管部门的认证过程中为客户提供支持。这包括薄片材料的清洁过程、供料的质量监控以及欧盟食品安全局定义的标准下的生产。

另一个功能特征是自动记录相关生产数据。欧盟食品安全局审核要求将认证过程中的配方和产品相关数据保存数年。ExtrusionOS生产合规性软件包是专门开发来用于监控和安全记录生产过程以及实时数据库中欧盟食品安全局相关阈值的合规性。实时仪表板透明展示提供了正在进行的生产和阈值，允许对异常快速响应。ExtrusionOS生产合规性是基于莱芬豪舍的连接解决方案Extrusion OS Core&c.Hub中间件，也可以对现有线路进行改造。

通过ExtrusionOS，生产数据也可以传输到数字产品护照——例如，通过开放式回收循环 (R-Cycle) 标准。数字产品护照是与初步产品和制成品之间明确关联的数据记录，其中，包含产品材料、成分和使用的具体数据。具体标记允许其用于基于数据的，因此更精确的废物分类和回收过程等等。

If recycled material comes into direct contact with food, it requires special certification from the European Food and Safety Authority (EFSA). Up to now, the production of sheet for food packaging of this type has been very laborious and complicated. Reifenhäuser MIREX PET lines now simplify the task for processors. By using a co-rotating twin-screw extruder and a specially developed high-performance vacuum system, the certified process allows PET recycling material to be processed directly without pretreatment and predrying – processes that are usually required. Processors then save their investment in an extra line component and avoid additional energy and maintenance costs. It also allows for quick material and product changes, for example from post-consumer PET bottle flake (PCR) to post-industrial PET production waste (PIR) or to virgin PET. The end product, such as a meat tray, then meets extremely high hygiene standards and is EFSA-compliant for use in direct contact with food. Reifenhäuser Cast Sheet Coating supports customers during the certification process with the competent authorities. This includes the cleaning process of the flake material, quality monitoring of the feed material, and production under the criteria defined by EFSA.

Another feature is the automatic documentation of relevant production data. EFSA audits require recipe- and product-related

data from the certified process to be stored for several years. The ExtrusionOS Production Compliance software bundle was specially developed to monitor and securely document production processes and compliance with EFSA-related thresholds in a real-time database. A live dashboard provides a transparent display of ongoing production and thresholds, permitting rapid response to anomalies. ExtrusionOS Production Compliance is based on Reifenhäuser's connectivity solution ExtrusionOS Core & c.Hub Middleware. It can also be retrofitted to existing lines. Via ExtrusionOS production data can also be transferred to a digital product passport - for example, via the open R-Cycle standard. Digital product passports are data records clearly linked to preliminary and end products that contain specific data on the materials, ingredients, and utilization of the product. Specific markings allow their use for data-based and therefore more precise waste sorting and recycling processes, among other things.

► **Reifenhäuser Cast Sheet Coating GmbH & Co. KG**  
 Spicher Str. 46 53844 Troisdorf, Germany  
<https://reifenhäuser.com/de/unternehmen/reifenhäuser-gruppe/cast-sheet-coating>



## Our Vision - Sustainable Innovation!

BeOne global and diverse Kautex team, together with customers and partners, to create leading change and added value!



Join us in the BeOne World of Sustainable Innovation

Meet us at K 2022

**Hall 14  
booth  
A16/A18**



Schedule your #KautexExpert meeting right here



**Shunde Kautex Plastics Technology Co., Ltd.**  
 Shunde, China  
 T + 86 757 2733 0910  
 info@kautex-group.com  
[www.kautex-group.com](http://www.kautex-group.com)



OUR WEBSITE

# 确保海底电缆的最高质量

## Measuring Technology – Case Study: Highest Quality of Submarine Cables Ensured

青岛汉缆使用西科拉的X射线8700 NXT进行CV线末端的最终质量控制

*Qingdao Hanlan uses SIKORA's X-RAY 8700 NXT for final quality control at the end of the CV line*

当今世界面临着许多挑战，其中之一就是能源转型。为了成功，除其他事项外，需要最高质量的海底电缆将海上风电场的电力输送到更远的陆地。因此，中国制造商青岛汉缆依靠西科拉的X射线8000设备系列测量和控制设备对其CV生产线进行了质量控制。

*The world is facing a number of challenges today, one of which is the energy transition. For this to succeed, submarine cables of the highest quality are needed, among other things, to transport electricity from offshore wind farms over greater distances to the mainland. The Chinese manufacturer Qingdao Hanlan therefore relies on SIKORA's measuring and control devices of the X-RAY 8000 device series for quality control in its CV lines.*

一旦海底电缆出现故障，维修将非常耗时且成本极高。在电缆束最终再次埋入海底之前，必须确定受影响区域的位置，挖掘和提升电缆，切割缺陷区域并用带电缆接头的修补件替换。在此背景下，制造过程中的持续质量保证至关重要。因此，许多制造商依赖西科拉的X射线8000产品系列，这个系列是全球标准产品，已在CV生产线上安装了1800多台设备。该系统在线测量中压、高压和超高压电缆的不同电缆参数，最多有三层不同，从而确保满足要求的规格。

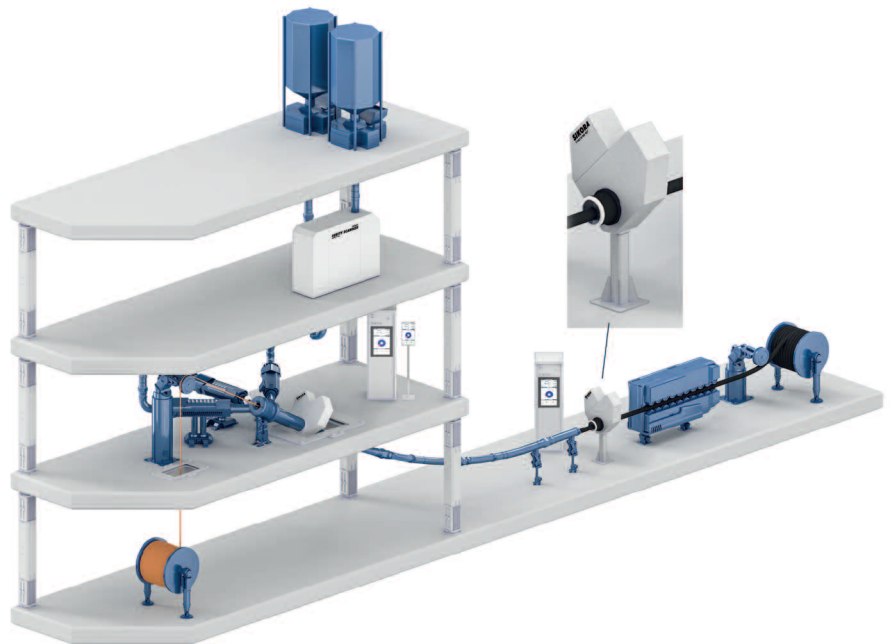

安装在CV线末端的X射线8700 NXT，用于最终质量控制

*The X-RAY 8700 NXT installed at the end of the CV line for final quality control*

为了向客户提供尽可能最好的质量，中国海底电缆制造商青岛汉缆还依赖于西科拉的X射线8700 NXT。该系统用于CV线的末端进行最终质量控制。它精确测量了海底电缆的管壁厚度、直径、离心率和椭圆度。通过这种方式，该公司得以确保只交付质量最高的无缺陷电缆。X射线8700 NXT可用于各种应用，如具有实心绞合导线的电缆以及具有单层绝缘、双层绝缘或三层绝缘的分割导体。此外，它还适用于基于聚丙烯的绝缘材料的质量控制。

青岛汉缆依靠西科拉的X射线8700 NXT对其海底电缆生产线进行最终质量控制

*Qingdao Hanlan relies on the X-RAY 8700 NXT from SIKORA for a final quality control in its submarine cable production line*

Once a submarine cable is defective, repair is very time-consuming and cost intensive. The affected area has to be located, the cable excavated and lifted, the defective area cut out and replaced by repair pieces with cable joints before the cable bundle is finally buried again on the seabed. Against this background, continuous quality assurance in the manufacturing process is essential. Therefore, many manufacturers rely on SIKORA's X-RAY 8000 product family, which is the worldwide standard with more than 1,800 installed devices in CV lines. The systems measure inline the different cable parameters of medium, high and extra high voltage cables with up to three different layers and thus ensure that the required specifications are met. In order to offer its customers the best possible quality, the Chinese submarine cable manufacturer Qingdao Hanlan also relies on the X-RAY 8700 NXT from SIKORA. The system is used at the end of the CV line for final quality control. It precisely measures the wall thickness, diameter, eccentricity and ovality of the submarine cables. In this way, the company ensures that only defect-free cables of the highest quality are delivered. The X-RAY 8700 NXT can be used for various applications, such as cables with solid stranded conductors as well as Milliken conductors with single, double or triple layer insulation. In addition, it is also suitable for quality control of insulation material based on polypropylene.



► SIKORA AG  
Bruchweide 2, 28307 Bremen, Germany  
[www.sikora.net](http://www.sikora.net)

## ► each detail matters for unrivalled performance

Only a company who has a constant focus on the productivity of its customers thinks ahead and creates extrusion solutions that leave the rest standing. SML specialises in the development of extrusion lines for film, sheet, coating and lamination as well as multifilament spinning lines.

**Extrusion lines.**  
Engineered to perform.

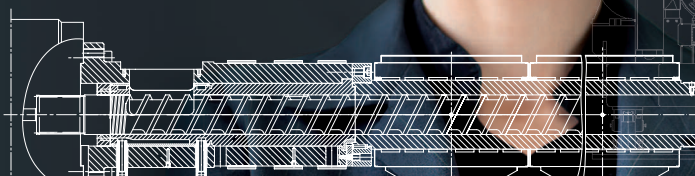

**SML**  
EXTRUSION LINES – ENGINEERED TO PERFORM ►

Be sure not to miss  
SML at the **K'2022**  
Stand No. 17/C39 & C42

[www.sml.at](http://www.sml.at)

# 通过物理发泡电缆保护管减少二氧化碳并节约成本

## Plastic Pipes: CO<sub>2</sub> Reduction and Cost Savings Through Physically Foamed Cable Protection Tubes

用于保护地下电缆的塑料管有多种直径和管壁厚度。有一点在所有情况下都是一样的：管道内的电缆应受到保护，免受环境影响和损坏。为确保这一点，必须满足明确规定导管特性的适当标准。

除其他外，这些标准规定了直径/管壁厚度比，该比例固定了每米管道的材料量。为了节省成本，通常使用回收物或B类商品，其性质和加工特性高度依赖于批量。

*Plastic pipes for protecting cables in the ground are available in a wide variety of diameters and wall thicknesses. One thing is the same in all cases: the cables inside the pipe are to be protected from environmental influences and damage. To ensure this, appropriate standards must be met that clearly specify the properties of the conduit. Among other things, these standards specify the diameter/wall thickness ratio, which fixes the amount of material per running meter of pipe. To save costs, recyclates or B-goods are often used, whose property profile and processing characteristics are highly dependent on the batch.*

### 使用环保气体节约成本

另一种降低成本和塑料消耗的方法是对管道进行物理发泡。这里，环境友好气体，如二氧化碳或氮气，被注入塑料中，并在挤塑机中与塑料混合。在随后的管道挤出过程中，这些气体形成细孔泡沫，从而减少重量，节省塑料。

### 合资企业——为最佳结果共同努力

在汉斯韦伯机械厂（Hans Weber Maschinenfabrik）和普罗米克斯解决方案公司（Promix Solutions）的一个联合项目中，现已确定了项目可行性、实用性和节约潜力。为此，韦伯公司为泡沫中间层提供了NE7.40型开槽机筒挤出机，为内层和外层提供了NE5.40型开槽机筒挤出机。使用WEBER PKM250三层管模头作为模具。此外，还使用了汉斯韦伯有限公司（Hans Weber GmbH）技术中心提供的下游设备：冷却段、牵引辊和锯床。普罗米克斯解决方案公司还提供了一个N400加气站，该加气站配有用于精确计量氮气的适配注入器，以及一个用于均化和降低熔体温度的P1 180熔体冷却器。在初始试验中，使用了北欧化学（Borealis）的HDPE HE3490 LS，用于DN110 x 6.3电缆保护管，并用氮气发泡。

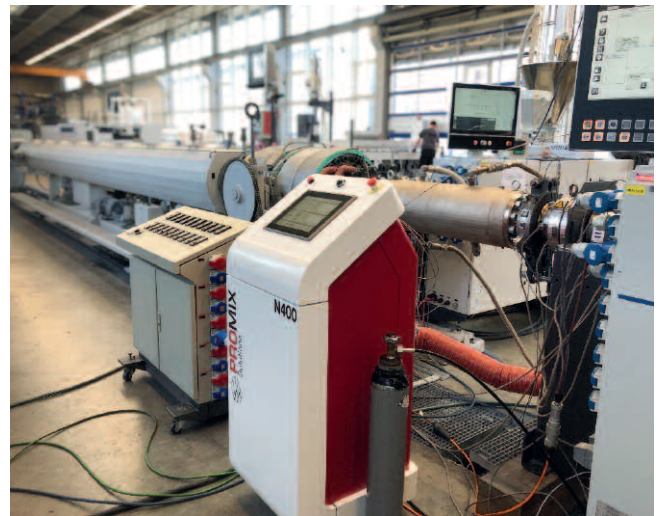

配备普罗米克斯（Promix）物理发泡系统的韦伯（Weber）管材挤出生产线

*Weber pipe extrusion line equipped with Promix physical foaming system*

生产无泡沫参考样品后，计量的气体量逐渐增加，导致原始材料重量减少至26%，回收材料重量减少了约15%（基于整个管道）。随后，按照德国DIN 16876标准和（瑞士）GAKSR 2010标准对以这种方式生产的管道进行了试验，并能够满足所有要求。根据德国DIN EN 744标准，特别注意了环刚度试验和跌落试验。基于这些积极结果，使用由回收HDPE制成的泡沫内层重复试验。这也显示了稳定工艺的良好可行性。

### 通过物理发泡电缆导管提高可持续性

鉴于目前聚合物的供应情况和不断上涨的材料价格，塑料管道的微孔发泡是节省材料和减少管道二氧化碳足迹的完美方法。与使用放热化学发泡剂发泡相比，不使用SVHC（高度关注的物质）列出的添加剂，也避免了通过再研磨再循环累积添加剂。当然，该技术也可用于其他管道系统。

在未来几个月，韦伯公司和普罗米克斯公司的联合试验将继续进行，以使用该技术进一步发泡管道变体、吞吐量和其他聚合物。此外，他们正在合作开发物理发泡PVC挤出物的解决方案。

### ***Saving costs by using environmentally friendly gases***

Another approach to reducing costs and plastic consumption is to physically foam the pipes. Here, environmentally friendly gases such as carbon dioxide or nitrogen are injected into the plastic and mixed with it in the extruder. In the subsequent pipe extrusion process, these gases form a fine-pored foam that leads to weight reduction and thus to savings in plastic.

### ***Joint venture – working together for the best result***

In a joint project of the companies Hans Weber Maschinenfabrik and Promix Solutions, the feasibility, practicality and savings potential have now been determined. For this purpose, WEBER provided a grooved barrel extruder type NE7.40 for the foamed middle layer and a grooved barrel extruder type NE5.40 for the inner and outer layers. A WEBER PKM250 3-layer pipe head was used as the die. In addition, the downstream equipment available in the technical center of Hans Weber GmbH: Cooling section, haul-off and saw were used. Promix Solutions provided an N400 gas dosing station with adapted injector for precise metering of the nitrogen and a P1 180 melt cooler for homogenization and temperature reduction of the melt. In the initial trials, Borealis' HDPE HE3490 LS was used for a DN110 x 6.3 cable protection tube and foamed with nitrogen.

After production of a non-foamed reference sample, the metered gas quantity was gradually increased, resulting in a weight reduction of up to 26 % for virgin material and approx. 15 % for recycled material – based on the entire pipe. The pipe produced in this way was subsequently tested in accordance with DIN 16876 and GA KSR 2010 (Switzerland) and was able to meet all requirements. Particular attention was paid to the ring stiffness and the drop test according to DIN EN 744. Based on these positive results, the test was repeated with a foamed inner layer made of recycled HDPE. This also showed good feasibility with a stable process.

### ***More sustainability through physically foamed cable conduits***

In view of the current supply situation for polymers and the ever increasing material prices, microcellular foaming of plastic pipes is a perfect way to save material and reduce the CO<sub>2</sub> footprint for the pipes. In contrast to foaming with exothermic chemical blowing agents, no SVHC (substances of very high concern) listed additives are used and an accumulation of additives via regrind recycling is also avoided. Of course, this technology can also be used for other pipe systems.



与传统产品相比，发泡电缆保护管使用的原材料减少了15%至26%。这节省了成本并增加了可持续性

*Foamed cable protection tube is using 15 to 26 % less raw material compared to conventional products. This saves costs and adds to more sustainability*

In the coming months, the joint tests of WEBER and Promix will be continued to foam further pipe variants, throughputs, and other polymers with this technology. Furthermore, they are working together on a solution for physically foamed PVC extrudates.

► **PROMIX Solutions AG**  
Technoparkstrasse 2, 8406 Winterthur, Switzerland  
[www.promix-solutions.com](http://www.promix-solutions.com)

# rPET/PET造粒的节能方案

## *Pelletizing: Energy-Saving Solution for Pelletizing of rPET/PET*

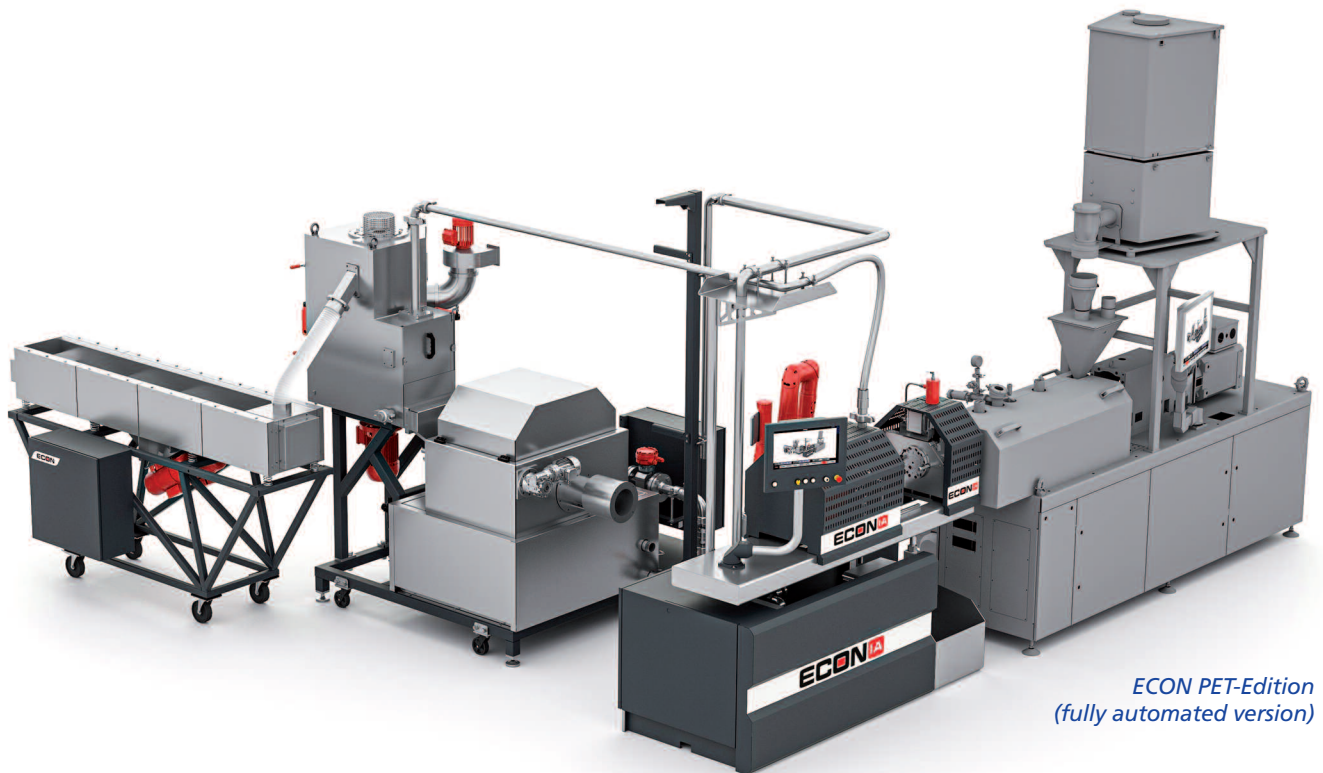

*ECON PET-Edition  
(fully automated version)*

在PET造粒的过程中，节能过程以及一定程度的结晶是非常重要的。当客户向ECON提出这一要求时，ECON作为技术领先者和值得信赖的开发伙伴，开始设计一款特别适合这些要求的水下造粒机。其结果是ECON PET-版，它已经针对PET进行了优化。ECON采用专利保温技术，并实现安全启动。

通过防止热量从模版单元传递到工艺水，不仅防止了模孔的冻结，而且节省了大量的能源。此外，ECON还特别注意对水箱和管道进行适当的保温，以使粒子的终端温度达到至少140°C。ECON可以根据客户的要求，提供个性化的解决方案，以确保所需的粒子终端温度。不仅将造粒机设计为以最低的能耗运行，就连下游设备--ECS（ECON PET结晶系统）也是如此。这种方法利用粒子的固有热量进行结晶，因此是PET结晶最有效的方法之一。该系统旨在将PET颗粒保持在一个恒定的温度，并达到30-40%的结晶度。在结晶通道中，颗粒经

*When it comes to pelletizing of PET, an energy saving process as well as a certain degree of crystallization is very important. When a customer approached ECON with this request, the technological leader and trusted development partner started to design an underwater pelletizer especially adapted to these requirements. The result is the ECON PET-Edition, which has been optimized for PET/rPET.*

由温和的振动进一步输送，并进行混合，以此防止在结晶过程中发生粘连。高度的结晶使颗粒在进一步加工（如注射成型）之前能够更快地预干燥，从而节省了大量的时间。

### 乙醛含量低

法律规定在食品领域，再生PET的乙醛含量必须尽可能的低。研发部团队负责人Dominik Neumann解释说：“与传统的切粒系统相比，我们开发ECON PET-版的目标是实现价值的大幅提升。我们与客户一起，深入研究了一个更高效的解决方



案”。通过将模板上的压力积聚减少40%，在造粒后直接实现了30-40%的低乙醛含量。以前的试验表明，由于减少的乙醛含量代表了不同的起始位置，因此在脱水过程中，可以预料会有较低的能量输入。

ECON PET-版是一个非常节能的解决方案，用于rPET/PET造粒，从而为循环经济做出贡献。“在PET回收方面，回收材料的产出比对生产线的盈利能力有显著影响，这意味着使用ECON技术可以带来显著的竞争优势” Gerhard Hemetsberger（销售总经理）如是说。ECON始终专注于根据客户的个性化需求，为客户量身定制解决方案。

#### 2022年K展:现场演示

在2022K展上，PET-版将在现场演示中以全自动版本亮相。ECON的另一个亮点是全新的EWFP (ECON专业的水过滤系统)。该过滤器达到了55微米的过滤等级，可以实现全自动和免维护的操作。除了运行设备，还将展出为挤出机螺杆专门研制的裂解炉- EPOS。



a significantly improved value in comparison to conventional pelletizing systems," explains Dominik Neumann, team leader of the R&D department. Together with the customer, we worked intensively on an efficient solution. By reducing the pressure build-up at the die plate by 40 %, a low acetaldehyde content of 30 to 40 % was achieved directly after pelletizing. Previous tests have shown that a lower energy input can be expected during dehydration, since the reduced acetaldehyde content represents a different starting position.

The ECON PET-Edition is a very energy-efficient solution for pelletizing rPET/PET and thus contributes to the circular economy. "When it comes to PET recycling, the kW/t of recycled material has a significant impact on the profitability of the production line. This means that using the ECON Technology results in a significant competitive advantage", says Gerhard Hemetsberger (Head of Sales). ECON always focuses on a tailor-made solution, based on the individual requirements of their customers.

#### K 2022: LIVE Demonstration

At K 2022, the PET-Edition will be displayed in a fully automated version during a live demonstration. Another highlight is the new EWFP (ECON Water Filtration Professional). The filter achieves a grade of filtration up to 55 µm and allows a fully automatic and maintenance-free operation. Besides the running equipment, the pyrolysis furnace – EPOS – specially developed for extruder screws will be exhibited.

With the help of the ECON patented thermal insulation technology, a safe start-up process is obtained. By preventing heat transfer from the die plate unit into the process water, not only is the freezing of die holes prevented, but a considerable amount of energy is saved. In addition, special attention has been paid to an appropriate insulation of the water tank and the piping in order to achieve an end temperature of the pellets of at least 140°C. Depending on the customer's requirements, ECON provides a tailor-made solution to ensure the required pellet end temperature. Not only is the pelletizer engineered to operate with minimum energy consumption, so the downstream equipment – the ECS (ECON Crystallization System for PET). This uses the intrinsic heat of the pellets for crystallization and is therefore one of the most efficient methods of crystallizing PET. The system is designed to keep the PET pellets at a constant temperature and to achieve a degree of crystallization of 30 to 40 %. In the crystallization channel, the pellets are conveyed further by gentle vibration and mixed to prevent sticking during crystallization. The high degree of crystallization enables a faster pre-drying of the pellets before further processing (e.g. injection molding), which saves a considerable amount of time.

#### Low acetaldehyde content

In the food sector, a low acetaldehyde content of recycled PET is required in order to be able to meet the legal guidelines. "Our goal in the development of the ECON PET-Edition was to achieve

► ECON GmbH  
Biergasse 9 | 4616 Weißkirchen | Austria  
www.econ.eu  
**K 2022: Halle 9, Stand C30**  
**K 2022: 9号厅, C30展台**

# 来自奥地利的回收技术用于澳大利亚最大的PET回收厂

## *Recycling Technology from Austria for Australia's Largest PET Recycling Plant*

最近在新南威尔士州阿尔伯里市建成投产的澳大利亚循环塑料PET回收工厂配备了一条来自史太林格的recoSTAR PET 215 HC iV+ PET瓶到瓶回收线，该生产线每小时产能约为2.5吨rPET。澳大利亚循环塑料PET公司是Pact集团、Cleanaway废料管理有限公司、朝日饮料和可口可乐欧洲太平洋合作伙伴（CCEP）之间的合资企业。

*The recently opened Circular Plastics Australia PET recycling facility in Albury-Wodonga, New South Wales, is equipped with a recoSTAR PET 215 HC iV+ PET bottle-to-bottle recycling line from Starlinger that produces 2.5 tons of rPET per hour. Circular Plastics Australia (PET) is a joint venture partnership between Pact Group, Cleanaway Waste Management Ltd, Asahi Beverages, and Coca-Cola Europacific Partners (CCEP) aiming to create a circular economy for PET beverage and food packaging.*



viscoSTAR SSP反应器中的真空处理用于IV增加和去污，使回收的PET可安全用于食品接触包装 (©CPA)

*Vacuum treatment in the viscoSTAR SSP reactors for IV increase and decontamination makes the recycled PET safe for food-contact packaging (©CPA)*

Albury新安装的recoSTAR PET 215 HC iV+将消费后的PET薄片转化为可食品接触rPET颗粒。首先对热洗薄片进行两个阶段的预加热和预干燥，以便进一步优化挤出效果。在挤出、过滤和水下造粒后，生产的rPET颗粒在下游SSP反应器中进行真空处理，以增加IV值和高效去污，为rPET颗粒的食品接触应用做好准备。

### 携手合作，实现闭环

澳大利亚循环塑料公司 (CPA) 计划每年回收30,000吨通过特定回收装置以及街道收集的消费后PET，并将使用食品级rPET颗粒作为原料生产新的饮料瓶和其他食品和饮料包装。合资企业的每个成员都提供了其在该项目中的专业知识和经验：Cleanaway通过其收集和分类网络提供要回收的塑料，Pact运营该设施并提供技术和包装专业知识，而朝日饮料、CCEP和Pact则从该设施购买回收塑料用于包装。阿尔伯里工厂的投产将有助于将当地采购和回收的PET数量从每年约3万吨增加到5万吨，增长了三分之二以上，并大大减少澳大利亚对进口的纯塑料和回收塑料的依赖。

CPA (PET) Albury Wodonga设施得到了新南威尔士州政府“减少浪费，回收更多”倡议的500万澳元的资助，并得到了澳大利亚政府回收现代化基金的支持。

史太林格回收技术的商业主管Paul Niedl说：“这家合资企业是一项重大成就，具有优先地位，我们感到自豪的是，我们能够用我们的专业知识和技术支持澳大利亚循环塑料公司致力于可持续发展，并帮助在澳大利亚建立起塑料包装闭环系统。”

Pact的常务董事兼首席执行官Sanjay Dayal，他说：“这家位于阿尔伯里·沃东加 (Albury Wodonga) 的先进工厂的开业为澳大利亚塑料回收行业带来了新的游戏规则改变者。该工厂与我们的合作伙伴一起，通过在澳大利亚回收和制造PET饮料瓶和食品包装，创造了真正的循环经济，而无需从海外进口塑料材料。”

澳大利亚循环塑料公司正在墨尔本维多利亚州北阿尔托纳市建造第二个PET回收工厂，该工厂将配备史太林格 recoSTAR PET 330 HC iV+回收线，并将配备目前全球安装的最大SSP反应器。它将有能力回收相当于每年约10亿个PET饮料瓶。

The newly installed recoSTAR PET 215 HC iV+ at the Albury-Wodonga facility turns post-consumer PET flakes into food-contact rPET pellets, starting with a two-stage heating and drying process of the hot-washed flakes for optimum preparation for the extrusion process. After extrusion, thorough filtering and underwater pelletising, the produced rPET pellets undergo vacuum treatment in the downstream SSP reactors for IV increase and highly effective decontamination that readies the pellets for food-contact applications.

### Joining forces to close the loop

Circular Plastics Australia (CPA) plans to recycle 30,000 tonnes of post-consumer PET collected via container deposit schemes and kerbside recycling each year and use the food-grade rPET pellets as raw material to produce new beverage bottles and other food and beverage packaging. Each member of the joint venture provides its knowledge and expertise in the project: Cleanaway supplies the plastic to be recycled through its collection and sorting

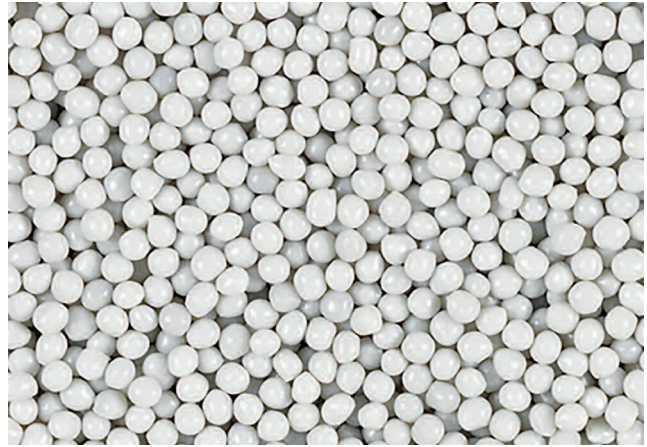

rPET颗粒将用于生产新的食品和饮料包装——这是一个功能循环包装系统的完美例子(©Starlinger)

*The rPET pellets will be used for producing new food and beverage packages – a perfect example of a functioning circular packaging system (©Starlinger)*

network, Pact operates the facility and provides technical and packaging expertise, while Asahi Beverages, CCEP and Pact buy the recycled plastic from the facility to use in their packaging. The output of the Albury-Wodonga plant will help to increase the amount of locally sourced and recycled PET by two thirds from around 30,000 tonnes to over 50,000 tonnes p.a. and reduce Australia's reliance on virgin plastic and recycled plastic imports.

The CPA Albury-Wodonga facility was supported by an AUD 5 million grant through the New South Wales Government's "Waste Less, Recycle More" initiative, with the support of the Australian Government's Recycling Modernisation Fund.

"This joint venture is a major achievement and sets precedence", said Paul Niedl, Commercial Head of Starlinger recycling technology. "We feel proud that we can support Circular Plastics Australia with our know-how and technology in their commitment to sustainability and help to establish a closed-loop system for plastic packaging in Australia."

Pact's Managing Director and CEO, Sanjay Dayal, said: "The opening of this state-of-the-art facility in Albury-Wodonga is a game changer for Australia's plastic recycling industry. Working together with our partners, this facility creates a true circular economy by recycling and manufacturing PET beverage bottles and food packaging here in Australia without the need to import plastic material from overseas."

CPA is building a second PET recycling facility in Altona North in Melbourne, Victoria, which will be equipped with a Starlinger recoSTAR PET 330 HC iV+ recycling line featuring the largest SSP reactor currently installed worldwide. It will have the capacity to recycle the equivalent of around one billion PET beverage bottles each year.

► **Starlinger recycling technology**  
Furtherstr. 47, 2564 Weissenbach, Austria  
[www.recycling.starlinger.com](http://www.recycling.starlinger.com)

# 具有50年历史的KÜNDIG控制系统 - 一个成功的故事

## *Measuring and Control Technology: A Success Story – 50 Years of KÜNDIG CONTROL SYSTEMS*

Your Profile    Our Business    50 Years



KCS属于家族企业HCH. KÜNDIG & CIE. AG (HKC) 的一个专业部门。自1972年以来, 新老员工一直开发和制造吹膜用测量和控制设备。以客户服务为导向的思维, 结合最高的制造精度, 使瑞士公司走向了世界之巅。

*Kündig Control Systems (KCS) is a division of the family-owned company Hch. Kündig & Cie. AG (HKC) specializing in thin plastic film measuring and control devices. Since its inception in 1972, the KCS team has steadily climbed its way to being the world leader in the blown film industry.*

在1971年的巴黎ITMA国际纺织机械展期间, 越来越多的迹象表明, 作为HKC当时的主要客户, 瑞士纺织机械行业和纺织厂的黄金时代迟早会结束。1970年10月, 公司决定聘请一名技术销售员, 并委托他在传统客户之外建立一个机器设备交易部门, 事实证明这是正确的, 但是现在回想起来, 这是一个雄心勃勃且要求很高的决定。

我们在主动拜访位于瑞士拉珀斯维尔-乔纳的前Vinora公司时, 他们提出了针对吹膜线的宽度控制设备的需求, 但当时计划销售的Meiners公司的宽度测量设备并不适合这个项目。HKC与一名年轻的电气工程师一起, 接受了内部研发的

挑战, 第一套设备在1972年售出, HKC由此为这个今天我们为庆祝成立50周年的专业部门奠定了基础。

KCS在“K 1979”上首次亮相的地点是杜塞尔多夫。客户对宽度控制感兴趣, 但另外明显也对薄膜测厚仪产生了兴趣。由于KCS不希望自己开发和制造测厚仪, 所以与位于美国明

尼阿波利斯市的Winzen公司结束了前不久的合作。当从美国采购的厚度传感器不再满足质量要求时, 我们决定开发我们自己的电容式测厚仪。K-100薄膜测厚仪于1987年完成全部研发, 此后不久销售给欧洲和北美的所有主要吹膜线制造商和终端用户。今天, 新旧多代强大的KCS测量和控制设备已在

各大洲使用多年，高效的售后服务确保了测厚仪的功能和效率。

从那时起，KCS就一直致力于研发更好的产品，测试新的科学发现并研发新的技术，提供世界上最创新的测量和控制设备，用来生产非常薄，且高质量的塑料薄膜，以节省宝贵的原材料和减少浪费，这始终是我们追求的目标。因此，KCS测量和控制设备不仅是一项经济投资，而且是一项生态投资。

在今年的K展上，KCS在全球首次展示了第9代宽度测量和控制技术。FE-9的宽度测量首次使用了一种全新的，创新的技术，拥有更精确的边缘检测。位于10号馆C51的展位有详细的技术介绍。与它的前辈一样，FE-9宽度测量系统由三种不同尺寸的两个测宽仪组成，它们可以在不同的位置相互连接。只需几个不同的模块，该系统就可以测量10到4000毫米之间的薄膜宽度。

CUFE-9操作台也是全新的，它结合了50年的宽度控制经验和最先进的技术。如果把CUFE-9集成到公司网络中，系统可以完全通过网络浏览器远程控制。此外，1985年推出的第6代以及此后推出的测宽仪也可以连接到CUFE-9。

在上次K展上推出的以X射线技术为基础的在线薄膜测厚仪“K-XRAY Rotomat KT 3G”已经成为世界市场上的代表性产品。在一些情况下，基于固态伽玛辐射源的测厚仪也被K-XRAY传感器所取代。因此，可以更精确地测量薄膜，结合薄厚控制，从而获得更小的薄厚公差。

拥有50年历史的KCS绝不会在荣誉面前固步自守。KCS专业部门的研发线充满了活力，高度积极的，勤奋的员工正在尽他们最大的努力，以确保全新的，高精度，创新的测量和控制设备，以最佳的性价比在不久的将来推向世界市场。

最后，KCS要对其全球客户多年来的良好合作和忠诚的伙伴关系表示衷心的感谢。如果没有他们对KCS测量和控制设备的投资，这个成功的故事就不可能被写出来。

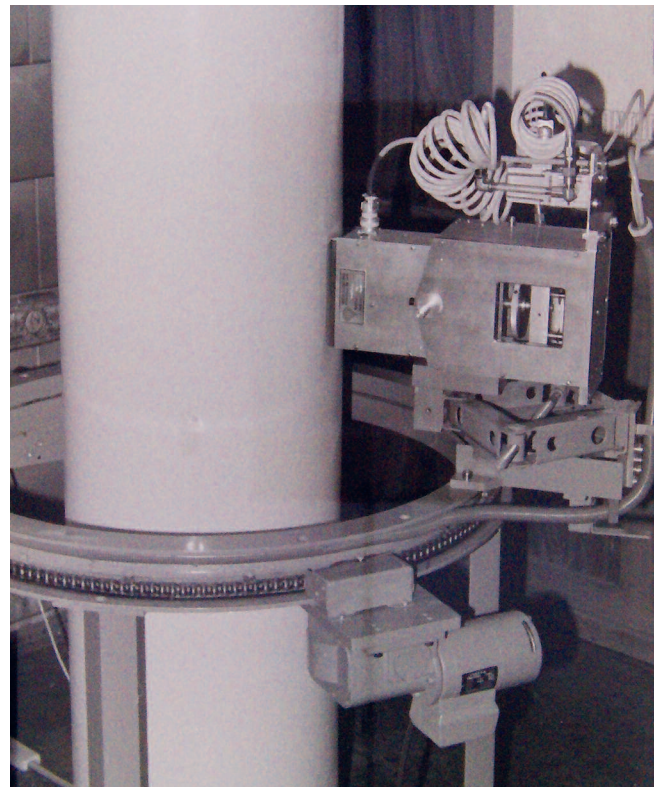

KCS-400: KCS在80年代初发布的第一台测厚仪

*KCS-400: First thickness gauge from KCS released early 80's*

It was during the 1971 International Textile Machinery Exhibition (ITMA) in Paris, that it became apparent that the golden years of Switzerland's powerful textile industry would soon be over. Textile machinery was the parent company's core business and the exhibition validated a HKC decision to search for an additional business avenue, a business avenue needed to ensure the company's future. Earlier in 1970, HKC hired a technical salesman and entrusted him with the task of setting up a trading department for machines and equipment outside of HKC's traditional clientele. Instead of textiles, the focus shifted to include thin plastic films. It proved to be the right decision, even though, in retrospect, it was a very ambitious and demanding choice.

The new KCS division got its first opportunity to solve a plastics industry problem during a spontaneous visit to the former Vinora company located in Rapperswil-Jona, Switzerland. Vinora needed a new width control device for blown film extrusion lines to replace the unsuitable devices then available from the Meiners company. KCS decided this was a challenge they would tackle with the added assistance from a young electrical engineer. The first width control device was sold in 1972, thus establishing KCS's foundation for the new division, which is celebrating its anniversary today.

KCS exhibited for the first time at K 1979 in Dusseldorf. The in-

terest in width controls and now, film thickness gauges, was significant. Since KCS did not want to develop and manufacture thickness gauges internally, they made a cooperation agreement with the Winzen company of Minneapolis, Minnesota USA. As time went on, the quality requirements of Europe's film industry began to exceed the capabilities of the sensors procured from the USA. Therefore, the next new challenge was the KCS's decision to develop their own capacitive thickness gauge. In 1987, the now infamous K-100 film thickness gauge was fully developed and shortly thereafter was sold to all major blown film line manufacturers and end users in Europe and North America. Today, the high quality KCS measurement and control devices of older and newer generations have been in use for years on all continents and their functional efficiency is guaranteed by an efficient customer service department.

Since these beginnings, KCS has continued to develop performance improvements in all its products, testing new scientific findings and developing new technologies. KCS's guiding principal is to offer the world's most innovative measuring and control equipment for the production of very thin, high quality plastic films - which reduce raw material usage. Clearly, an investment in equipment from KCS is clearly both an economic and ecological decision.

At this year's K show, as a world premiere, KCS presents the 9th generation of width measurement and control. For the first time, the FE-9 width measurement uses a new, innovative technology for even more precise foil edge detection. Detailed explanations of this technology are available at booth C51 in Hall 10. As with

its predecessor, the FE-9 width measurement system consists of two half-beams in three different sizes, which can be connected to each other at different positions. With only a few different modules, this system enables width measurement of film webs between 10 and over 4000 millimeters.

The CUFE-9 operator console, which is also new, combines 50 years of experience in width control technology with state-of-the-art technology. If the CUFE-9 is integrated into the company network, the system can be completely controlled remotely via a web browser. In addition, width measuring instruments from the 6th generation introduced in 1985 can be connected to the CUFE-9.

The online film thickness gauge K-XRAY Rotomat KT 3G based on X-ray technology, which was introduced at the last K trade show, is now an established device on the global market. On several occasions, thickness gauges based on a gamma solid-state radiator have also been replaced by a K-XRAY sensor. As a result, thin foils can be measured much more precisely, which, in combination with profile control, leads to decisively tighter cross-profile tolerances.

By no means will the 50-year-old KCS now rest on its laurels. The development pipeline is full to bursting and highly motivated, hard-working employees of the KCS specialist department are doing their best to ensure that new, high-precision, innovative measuring and control devices with the best price-performance ratio will soon be launched on the world market.

**K-RAY Rotomat:**  
从伽马射线到X射线的改装包  
伽马射线到X射线

*K-RAY Rotomat:  
Retrofit package from  
gamma-ray to X-ray*

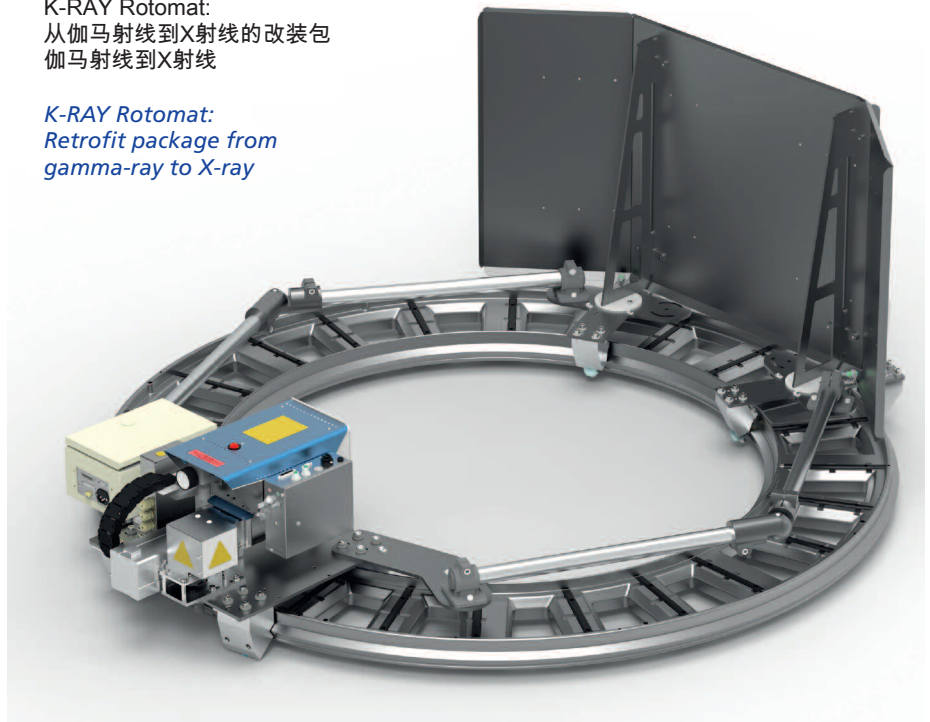

*Finally, KCS would like to send a huge thank you to its worldwide customers for their good cooperation and their loyal partnership over many years. Without their investments in measuring and control equipment from the KCS, this success story could never have been written.*

► **HCH. KÜNDIG & CIE. AG**  
Joweid Zentrum 11, 8630 Rüti ZH, Switzerland  
[www.gauge.ch](http://www.gauge.ch), [sales@gauge.ch](mailto:sales@gauge.ch)  
**K 2022: Hall 10, Stand C51**





# 全球塑料和橡胶行业共同积极推动气候保护、循环经济和数字化进程

## *Global Plastics and Rubber Industry Jointly Active for Climate Protection, Circular Economy and Digitalization*

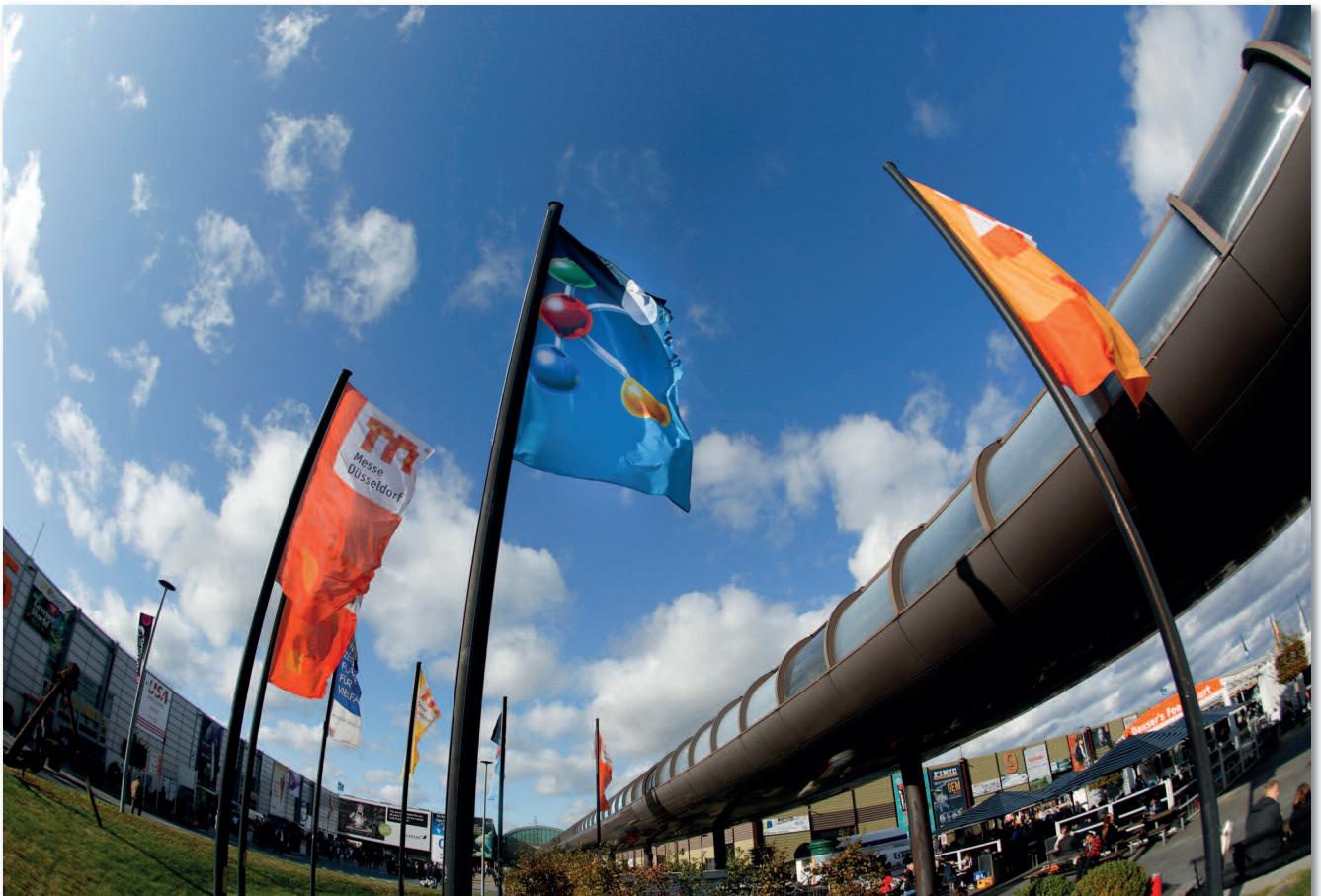

(照片 / Photo: Messe Düsseldorf, Constanze Tillmann)

■ 杜塞尔多夫的K展是全球整个行业最重要的会议场所。来自世界各地的参展商来到杜塞尔多夫，展示行业的能力，并与参观者一起积极制定未来的发展方向。这显然引领了气候保护、循环经济和数字化的方向--这也是K2022年宣布的三个指导性主题。

来自61个国家的约3000名参展商将占据整个杜塞尔多夫展览中心。

■ K in Düsseldorf is the world's most important meeting place for the entire industry. Exhibitors from all over the world come to Düsseldorf to demonstrate the industry's capabilities and actively set the course for the future together with visitors. These clearly lead in the direction of climate protection, the circular

economy and digitalization – and these are also the three declared guiding themes of K 2022.

The approximately 3,000 exhibitors from 61 countries will occupy the entire Düsseldorf exhibition center.

**19 - 26 October 2022,  
Duesseldorf, Germany**  
2022年10月19-26日，  
德国杜塞尔多夫

► [www.k-online.de](http://www.k-online.de)



## K展会2022—— 杜塞尔多夫展览公司确保了最高的空气质量

■ 杜塞尔多夫展览公司 ( Messe Düsseldorf ) 将推出新的技术亮点：高效空气过滤器。这些高效微粒空气过滤器将医护级洁净的空气引入大厅，同时减少加热和冷却能耗。自2022年6月底起，杜塞尔多夫展览和会议中心已配备高效空气过滤器。

这是目前可用的最有效的空气净化技术：高效空气过滤器从空气中去除99.9%的病毒、细菌和其他微粒，并将净化后的空气再次释放到室内。这些高效过滤器可在手术室、重症监护室以及杜塞尔多夫展览和杜塞尔多夫会议提供最高的空气质量。

杜塞尔多夫展览公司总裁兼首席执行官Wolfram N.Diener强调了重新启动的优势，说：“我们新的HEPA过滤器有助于确保我们在展会期间为所有客人提供最大可能的保护。结合我们的高性能通风系统、自愿卫生措施、宽敞的场地和大厅，我们将感染风险降至最低。在经历了两年的大流行病和一段时间的密集数字通信后，参与者可以在以下情况下感到安全：工作，发起商业交易，再次亲身体验创新。”

除HEPA过滤器和通风系统外，杜塞尔多夫展览公司的自愿卫生措施也提供了额外的感染防护。交易展会公司持续建议与会者佩戴医用口罩，并与展会场地上的其他人保持1.5米的距离。此外，杜塞尔多夫展览公司还提供消毒分配器，并每天多次清洁接触面。等候区的距离标志有助于防止在问讯柜台和售票处前形成人群。门（除非是防火门）保持打开，以便无接触地通过。服务和信息柜台的透明液滴防护装置也将保持不变。

### *K 2022 – Messe Düsseldorf Ensures Highest Air Quality*

■ Messe Düsseldorf is coming up with a new technical highlight: HEPA filters. These high-efficiency particulate air filters introduce clinically clean air into the halls while at the same time reducing heating and cooling energy consumption. Since the end of June 2022, the complete Düsseldorf Exhibition and Congress Centre is equipped with HEPA filters.

It is the most effective air cleaning technology currently available: HEPA filters remove 99.9% of viruses, bacteria and other particulates from the air and release



( 资料来源：杜塞尔多夫展览/希提尔曼 ( Messe Düsseldorf/ctillmann ) )  
(Credit: Messe Düsseldorf/ctillmann)

the cleaned air into the room again. These high-efficiency filters make for highest air quality in ORs, at Intensive Care Units and now also at Messe Düsseldorf and Düsseldorf Congress.

Stressing the advantages for the re-start, Wolfram N. Diener, President & CEO of Messe Düsseldorf, says: “Our new HEPA filters help to ensure that we can offer all guests the greatest possible protection during our trade fairs. In combination with our high-performance ventilation system, our voluntary hygiene measures, our spacious premises and halls, we reduce the infection risk to a minimum. After two pandemic years and a period of intense digital communication participants can feel safe when networking, initiating business deals and experiencing innovations in person again.”

Additional infection protection is not only

provided by the HEPA filters and ventilation systems but also by Messe Düsseldorf’s voluntary hygiene measures. The trade fair company continues recommending attendees to wear medical face masks and keep a 1.5 m distance from other persons on the fairgrounds. Furthermore, Messe Düsseldorf makes sanitizing dispensers available and has frequently used contact surfaces cleaned several times daily. Distance markings in waiting areas help to prevent crowds from forming in front of information counters and ticket offices. Doors, unless they are fire doors, are left open so that they can be passed through contactless. Transparent droplet guards at service and information counters will also remain in place.

► Messe Düsseldorf GmbH  
www.k-online.de



## 测量技术：可持续发展的未来技术

■ 西科拉 (Sikora) 在2022K展上的焦点是两款新型号的CENTERWAVE 6000系列机型的全球首发式, 该系列用于在挤出过程的早期使用毫米波技术测量管道。此外, 还将推出配备三台光学摄像机和一台X射线照相机的先进纯度扫描仪, 以实现最高性能的塑料颗粒检查和分拣。此外, 还邀请参观者使用实验室测试设备PURITY CONCEPT V现场检查、分析颗粒物。由于节约是西科拉技术的一部分, 参观者将了解如何在挤出生产流水线节约材料、成本和二氧化碳。

### 全球首：全新CENTERWAVE 6000/1200

西科拉所供应的CENTERWAVE 6000用于在线测量塑料管的管壁厚度、内轮廓和直径以及整个圆周上的椭圆度。随着CENTERWAVE 6000/1200在全球的首发, 一种新的型号现已上市, 其直径范围从250毫米到1200毫米。因此, CenterWave 6000/1200满足了大直径管道制造商的需求。“由于其超薄的设计, 新型号可以轻松集成到生产线中, 特别适用于生产直径达1000和1200mm的挤出生产线,” 软管和管材销售主管 Christian Schalich表示。该系统支持即时对中、无缝、可靠的质量控制和可选的自动控制。所有型号的中心波6000设备系列都具有基



在K展会上, 西科拉首次推出了适用于250至1200 mm管径的CENTERWAVE 6000

*At K, SIKORA presents for the first time the CENTERWAVE 6000 for pipe diameters from 250 to 1,200 mm*

于毫米波技术的创新测量原理。只需按下一个按钮, 操作就很直观。“一旦激活, 操作员立即接收连续和精确的测量值——无需预设产品参数, 不受耦合介质 (水) 的影响, 也无需任何校准,” Schalich解释道。为了确保这一点, 测量系统自动确定测量位置处材料的准确折射率。Schalich说: “获得专利并因此独特的是连续测量管壁的一个非常重要的特征值: 材料的折射率。借助它, 可以精确地确定管壁厚度和外径, 而无需校准测量系统。”在真空罐之后, 除了对折射率的了解外, 还可以直接测量管壁厚度和外径该测量已经提供了在挤塑生产线末端冷却后预期的管壁厚度和直径值的精确预测。由于该程序, 任何时候都不需要在改变生产条件时手动输入折射率。“CENTERWAVE6000之所以令人信服, 主要是因为该技术为挤塑工艺提供了优势,” Schalich解释道。“一键操作”排除了操作错误, 快速实现了目标尺寸, 避免了启动报废, 确保了最高质量, 并优化了工艺控制。

### 全球首发：全新CENTERWAVE 6000/250

来自西科拉的毫米波技术之前已知

CENTREWAVE 6000的测量值清晰可见

*Measuring values of the CENTERWAVE 6000 are clearly visualized*

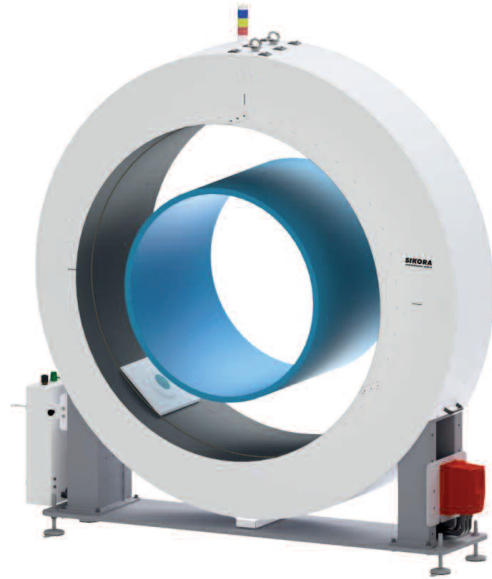

用于测量更大的管道。在K展上, 西科拉首次推出了中心波6000/250, 适用于50至250 mm的较小管径。由于其自动调节转速, 可100%测量管壁厚度, 并可确定管壁厚度为1.5 mm的管材的直径和椭圆度。所有CENTERWAVE设备一样, 该系统配备了围绕产品连续旋转360度的收发器。这样, CENTERWAVE 6000/250自动将收发器的旋转速度调整到线路速度, 从而确保质量控制100%无缝。

### 新颖性：采用三台创新的25μm高分辨率黑白相机的高级纯度扫描仪

塑料市场正在发生变化。原材料短缺和价格上涨对该行业构成了挑战。因此, 制造商对颗粒物的质量控制需求也在增加。西科拉考虑到了这一变化, 并为纯度扫描仪提供了先进的模块化系统, 用于灵活的光学在线检查和塑料材料分类。“即使是最小的临界污染, 系统也能可靠地检测和分类。受污染粒子的检测和剔除完全协调进行,” 塑料销售主管 Ralf Kulenkampff解释道。由于采用了模块化概念, 可根据检查材料使用不同类型的摄像机。除了检测黑斑和变色的25μm高分辨率光学摄像机外, 还可以安装一台X射线摄像机来检测金属污染。市场上常见的系统最多有两个光学摄像机。然而, 一旦污染在摄像机的视野之外, 由于覆盖率相对较低, 它们很快就会达到极限。“通过在PURITY SCANNER ADVANCED中使用第三台黑白摄像机, 实现了显著更高的检测率, 从而



检测到更多污染物——这是我们系统的独特之处”Kulenkampff解释道。

PURITY SCANNER ADVANCED 通过吹扫装置自动分拣检测到的污染物。为了优化副产品，西科拉开发了“混合吹出”功能。客户可以提前定义材料中哪些污染物是非关键性的，并为这些污染物选择较小的吹出装置，从而减少其副产品。例如，这些包括材料中经常出现的浅色的黑斑。另一方面，对于可能损害后续最终产品功能的关键污染物，例如金属污染物，详述了更大的吹扫装置。“可靠检测和混合吹出的相互作用来确保材料质量达到最高。同时，优化了生产流程，减少了副产品，有助于成本效益和可持续生产。”Kulenkampff说道。

### 使用PURITY CONCEPT进行现场材料测试

对于用于斑点分析的塑料颗粒或测试板的随机抽样检查，西科拉在K展会上具有光学检测的PURITY CONCEPT系统（PURITY CONCEPT V）或X射线分析（PURITY CONCEPT X）。在几秒钟内，根据系统，检查测试材料是否存在金属污染或光学偏差。污染物自动检测、可视化和统计评估。在实验室环境中，在西科拉展台提供了PURITY CONCEPT V的现场材料测试。欢迎参观者免费提供颗粒样品，这些样品将直接在展台上使用PURITY CONCEPT V进行检查和分析。或者，参观者可以将少量颗粒物直接带到展台进行测试和评估，并亲自观察系统的精准度、速度和易用性。

### 服务

维护客户现场西科拉系统的可用性和效率是西科拉的首要任务。在K展会上，西科拉服务团队展示了其服务组合的整个范围。从设备的安装、调试到咨询和培训，始终满足客户的个性化要求。

### 测试节约潜力

在挤塑过程中，可通过使用可持续的测量技术来具体吸收成本。例如，CENTERWAVE 6000测量系统在管道生产中的最佳对中可节省约3%至5%的材料。启动废料减少到最低限度，除了材料，还节省了宝贵的生产时间，可用于处理额外的生产订单。此外，这在生产过程中节约了能源，同时通过节约宝贵的资源有助于提高可持续性。西科拉开发了自己的工具，用于计算材料、生产时间、成本和二氧化碳排放方面的可能节约潜力，该工具将首次在K展会上面向广大关注者展出。

### Measuring Technology: Innovative Technologies for a Sustainable Future

■ The focus of SIKORA's trade show appearance at K 2022 is the world premiere of two new models of the CENTERWAVE 6000 family for the measurement of pipes by means of millimeter wave technology already early in the extrusion process. Also new will be the PURITY SCANNER ADVANCED with three optical cameras and one X-ray camera for highest performance in inspection and sorting of plastic pellets. In addition, visitors are invited to inspect and analyze their pellets live and on-site with the laboratory testing device PURITY CONCEPT V. As savings are part of the SIKORA technologies, visitors will learn how they can save material, costs and CO2 in their extrusion line.

### World premiere: New CENTERWAVE 6000/1200

SIKORA offers the CENTERWAVE 6000 for online measurement of wall thickness, inner profile and diameter as well as ovality over the entire circumference of plastic pipes. With the world premiere of the CENTERWAVE 6000/1200, a new model is now available that specifically covers diameter ranges from 250 to 1,200 mm. The CENTERWAVE 6000/1200 thus meets the demands of large-diameter pipe manufacturers. "The new model can be easily integrated into the production line thanks to its slim design and is particularly suitable for extrusion lines in which pipe diameters of up to 1,000 and 1,200 mm are produced," says Christian Schalich, Head of Sales – Hose & Tube. In-line, the system supports immediate centering, seamless, reliable quality control, and optional automatic control. All models of the CENTERWAVE 6000 device series are characterized by their innovative measuring principle based on millimeter wave technology. Operation is intuitive at the push of a button. "Once activated, the operator immediately receives continuous and precise measured values – without presetting the product parameters, without the influence of a coupling medium (water) and without any calibration," Schalich explains. To ensure this, the measuring system automatically determines the exact refractive index of the material at the measuring position. "Patented and therefore unique is the continuous mea-



CENTREWAVE系列的最小型号，适用于50至250 mm的小产品直径

*The smallest model of the CENTERWAVE family for small product diameters from 50 to 250 mm*

surement of a very important characteristic value of the pipe wall: the refractive index of the material. With its help, both the wall thickness and the outer diameter can be precisely determined without having to calibrate the measuring system," Schalich says. Directly after the vacuum tank, knowledge of the refractive index, in addition to the measurement, already provides an accurate prediction of the wall thickness and diameter values to be expected after cooling at the end of the extrusion line. A manual input of the refractive index when changing the production conditions is not necessary at any time due to this procedure. "The CENTERWAVE 6000 convinces mainly due to the advantages that the technology offers for the extrusion process," Schalich explains. The "one-button operation" rules out operating errors, target dimensions are quickly achieved, start-up scrap is avoided, highest quality is ensured, and processes are optimally controlled.

### World premiere: CENTERWAVE 6000/250

Millimeter wave technology from SIKORA was previously known for the measurement of larger pipes. At the K, SIKORA presents for the first time the CENTERWAVE 6000/250, for smaller tube diameters from 50 to 250 mm. It enables

100 % measurement of the wall thickness, as well as the determination of diameter and ovality for tubes with wall thicknesses from 1.5 mm due to its automatic adjustment of the rotation speed. Like all CENTERWAVE devices, the system is equipped with a transceiver that continuously rotates 360 degrees around the product. In doing so, the CENTERWAVE 6000/250 automatically adjusts the transceiver's rotation speed to the line speed, thus ensuring 100 % seamless quality control.

**Novelty: PURITY SCANNER ADVANCED with three innovative 25 µm high-resolution black and white cameras**

The plastics market is changing. Raw material shortages and price increases are challenging the industry. Consequently, the demands of the manufacturers regarding quality control of pellets are also increasing. SIKORA takes this change into account and offers with the PURITY SCANNER ADVANCED a modular system for flexible optical online inspection and sorting of plastic material. "Even the smallest, critical contamination are reliably detected and sorted out by the system. Both the detection and the ejection behavior of contaminated pellets are perfectly coordinated," explains Ralf Kulenkampff, Head of Sales – Plastics. Thanks to the modular concept, different camera types can be used depending on the inspected material. In addition to optical 25 µm high-resolution cameras, which detect black specks and discolorations, an X-ray camera can be installed to detect metallic contamination. Common systems on the market have a maximum of

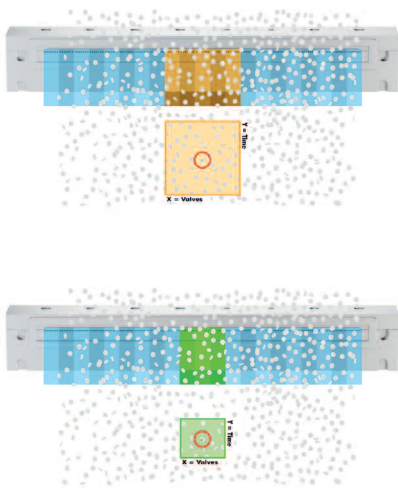

使用PURITY SCANNER ADVANCED检查塑料颗粒和给塑料颗粒分类

*Inspection and sorting of plastic pellets with the PURITY SCANNER ADVANCED*



two optical cameras. However, these quickly reach their limits due to relatively low coverage as soon as the contamination are outside the cameras' field of view. "By using a third black and white camera in the PURITY SCANNER ADVANCED, a significantly higher detection rate is achieved, so that more contaminants are detected – this is unique with our system," explains Kulenkampff. The PURITY SCANNER ADVANCED automatically sorts out detected contamination via a blow-out unit. For optimizing the by-catch, SIKORA has developed the "hybrid blow-out" function. The customer can define in advance which contaminants in the material are uncritical and select a smaller blow-out unit for these, so that their by-catch is reduced. These include, for example, small, light-colored black specks that frequently occur in the material. On the other hand, a larger blow-out unit is specified for critical contaminants, for example metal contaminants, which can impair the functionality of the subsequent end product. "The interaction of reliable detection and hybrid blow-out ensures the highest material

三个光学高分辨率黑白摄像机的组合确保了对塑料颗粒中25µm污染物检测的最高性能

*The combination of three optical high-resolution black and white cameras ensures the highest detection of contamination from 25 µm in plastic pellets*

quality. At the same time, production processes are optimized, and the reduced by-catch contributes to cost-efficient and sustainable production," says Kulenkampff.

**Live material tests with the PURITY CONCEPT**

For random sample inspection of plastic pellets or test plates for speck analysis, SIKORA presents at the K the PURITY CONCEPT Systems with optical inspection (PURITY CONCEPT V) or X-ray analysis (PURITY CONCEPT X). Within a few seconds, depending on the system, the test material is inspected for metal contamination or optical deviations. Contaminants are automatically detected, visualized and statistically evaluated. In a laboratory environment live material tests with the PURITY CONCEPT V are offered at the SIKORA booth. Visitors are invited to send in free of charge pellet samples, which will be inspected and analyzed directly on the booth with the PURITY CONCEPT V. Alternatively, visitors can bring small quantities of their pellets directly to the booth for testing and evaluation and personally convince themselves of the precision, speed and ease of operation of the system.

**Service**

Maintaining the availability and efficiency of the SIKORA systems at the customer's site is SIKORA's top priority. At the K, the SIKORA service team presents the entire range of its service portfolio. From instal-



lation and commissioning of the devices to consulting and training, always matching the individual customer requirements.

### Testing savings potential

In extrusion, costs can be specifically absorbed by using sustainable measuring technology. For example, optimal centering in pipe production by the CENTER-WAVE 6000 measuring system leads to a material savings potential of approx. 3 to 5 %. Start-up scrap is reduced to a minimum and, in addition to material, valuable production time is saved which can be used for processing additional production orders. In addition, this saves energy during production and at the same time contributes to more sustainability by conserving valuable resources. SIKORA has developed its own tool to calculate possible saving potential in terms of material, production time, costs and

“混合吹出”功能允许客户筛选材料中那些不重要杂质，并为这些杂质选择较小的吹塑装置，从而减少其副产品

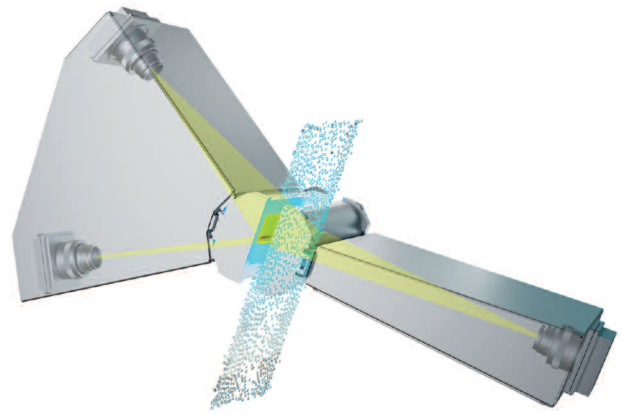

*The “Hybrid blow-out” feature allows the customer to select which impurities in the material are not critical and to choose a smaller blow-out unit for these, so that their by-catch is reduced*

CO<sub>2</sub> emissions which will be presented for the first time to a broad audience at the K.

► SIKORA AG  
www.sikora.net  
K 2022: Hall 10, Stand F14  
2022K展：10号展厅，F14号展位

## 适用于整个挤出行业的完整生产线

■ 巴顿菲尔辛辛那提拥有合适的机械和设备，可以生产几乎所有的塑料挤出半成品，从定制的单一组件到优化的交钥匙生产整线。基于此，这家位于德国巴腾奥因豪森的挤出设备制造专家为来自管材、型材、板片材挤出，以及造粒挤出生产的客户提供服务。集团董事长兼总经理兼首席执行官杰罗德·施莱先生在描述其产品系列的独特卖点时曾说道“我们整条生产线的特点是它们不仅没有任何接口问题，并由完美同步的单一组件组成，整线完全来自单一供应商”。在 K 展中，巴顿菲尔辛辛那提通过揭示其管材

挤出生产线的全新一致设计，首次展示了其完整的生产线能力，并成为今年令人垂涎的 IF 奖的获得者。

在今年最重要的塑料行业世界贸易展览会中，循环经济、数字化和气候保护的首要主题恰恰反映了整个塑料行业的情况，这是合乎逻辑的。“我们的座右铭‘全球可持续解决方案’丝毫没有失去它的现实性。因此我们今年将在杜塞尔多夫展示挤出设备，以满足客户对提供节能、节省空间、低维护、灵活性和高性能概念的需求”，杰罗德·施莱先生强调说。

### 管道行业的水处理和新设计

在 K 展中，巴顿菲尔辛辛那提将推出全新的生产整线标准化设计，从 2023 年起，所有管材挤出生产线都将以公司企业色来呈现。除了视觉效果，最重要且最吸引人的亮点是新设计的功能性：最佳的可访问性及用户友好性，包括其易于清洁的主要特性。从挤出机到定型，冷却装置和真空，再到切割和翻料台，所有组件均由巴顿菲尔辛辛那提制造，不仅在技术上，如今在视觉上也完美匹配，没有任何界面问题，并已集成到操作直观的 BCtouch UX 控制系统中。

新的管材挤压生产线 / *New pipe extrusion line*



巴顿菲尔辛辛那提为管道行业提供完整的挤出生产线，涵盖从农业滴灌到用于水处理的大口径管道的各种应用。这两款应用也将在 K 展台展示。在大口径管道方面，巴顿菲尔辛辛那提实际上已经创造了一项新的记录。

首条直径达 2,700 毫米的管道生产线已经交付使用。大口径管材挤出生产线的两个亮点是管材模头采用了 Opti-melt 系统，以最低的熔体温度提供理想的熔体均质化，从而最大限度地减少熔垂。巴顿菲尔辛辛那提凭借下游设备全新打造的 4 米长段，解决了设备的超大尺寸和相关运输问题。这是首次完成了分段长度只有 4 米的真空和喷淋装置。这些单一的组件非常便于运输及现场组装。

巴顿菲尔辛辛那提位于巴腾奥茵豪森技术实验室为客户试运行而组装了新生产线，参观 K 展的观众可以通过观看视频演示，来见证巴顿菲尔辛辛那提的滴灌专业技术。滴头是该视频演示的亮点之一，其简单且巧妙的设计可确保非常均匀地连续供水。在挤出过程中，这些由巴顿菲尔辛辛那提与合作公司开发的滴头将通过管模射出，并在管子仍然很热的时候即时完全地焊接到管子内，不再需要在滴头上为出水口钻孔或打孔。同时，该滴头的设计确保了较长的使用寿命，不会因水垢、污垢或植物生长而堵塞出水口。

K 展的展台上另一个新产品是小型 solEX NG 挤出机，它以最小的尺寸完成了用于管材挤出的高速挤出机系列。至此，除了现有的 60、75、90 和 120mm 的四种 solEX NG 系列型号之外，还将提供 solEX NG 45。该系列的一个显著特点是内部开槽的机筒与匹配的特殊螺杆几何形状相结合，具有以下优点：产量提高多达 40%，熔体温度降低约 10 °C，能耗降低 15%。

### 环保产品的理想挤出解决方案

近年来，基于高填充塑料的地板覆盖物经历了巨大的发展。这些通常是基于 PVC-的配方。鉴于可持续性讨论，毫无疑问，PP 将在该领域发挥主导作用并部分取代 PVC。

基于后续的加工步骤，如印刷，以及后期的应用领域，对辅地材料在无张力、平整度和厚度公差方面的要求非常高。PP 的半结晶结构为这项任务增加了很大的难度。

事实证明，巴顿菲尔辛辛那提的 Multi-Touch 辊组非常适合生产由 PP 制成的环保地板。几家首批客户在实际使用中清楚的证明了这一点。这种独特的辊组配备多达九个用于预定型和重新定型的冷却辊，可确保在熔体离开平模后，板材和冷却辊之间长时间保持紧密

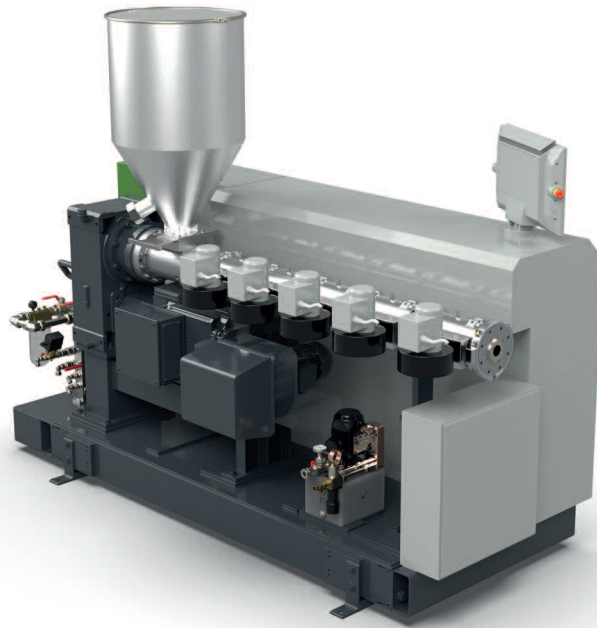

Multi-Touch

接触。顶部和底部的冷却几乎同时进行。通过这种方式，可以制造出尺寸准确、外观精美的半成品，具有理想的平整度和最低的厚度公差，非常适合地板应用。然而，不仅可用于地板覆盖物，而且还用于制造冰箱面板或其他由 PS 或 PP 制成的表面面板，这种辊组已成为国际需求，并且已经在多个国家投入使用。在 K 展位中，巴顿菲尔辛辛那提将展出 Multi-Touch 辊组，感兴趣的客户可以与相关人员就其广泛的应用进行交流，包括双面平滑薄膜的生产。

巴顿菲尔辛辛那提还为 PVC 应用挤出提供完美的挤出机。最新的证明是可提供带或不带电动剪切间隙调节 (EMS) 选项的新型造粒挤出机系列 - aglomEX。这些挤出机不仅适用于原始材料，也适用于来自 Rewindo 收集系统等 PCR 产品。巴顿菲尔辛辛那提将在展台上展示的 aglomEX 114 挤出机，其最引人注目的特征是 6D 加长塑化处理单元，目前所有五款型号均已安装完毕。由此，挤出机不仅可满足 PVC 行业对各种加工各种原材料的能力需求，而且还实现了高达 20% 的高产出率，积极响应了对高效率的普遍要求。

### 走向全自动挤出生产线

自动化和数字化不仅促进了日常生产流程，还满足了高生产效率、减少安装时间和低废品率的要求。在今年的 K 展中，最令人印象深刻的将是巴顿菲尔辛辛那提针对管材和片材挤出生产而开发的系统。快速变径 (FDC) 是一个在生产过程中按下按钮，即可在各种直径范围内变换管道尺寸的系统。不仅是管模上的熔体间隙，而且所有下游组件都可以同时调整为新的管道尺寸，且无需任何人工干预。因此，管材制造商甚至能

够高效地完成小批量订单，并将废品量降至最低，从而使他们的生产更加环保。日常生产中的类似助手也可用于片材和板材挤出生产线。例如，片材挤出中的挤出机和熔体泵组合操作可显著促进开机启动。这不但节省了时间和成本，而且还能最大限度地减少了启动废料。平模头和辊组的自动调整，以及补偿系统，也简化了操作，提高了生产效率。

在 K 展上，巴顿菲尔辛辛那提还将展示一款适用范围广泛的 Steady flow 模块，这是用于 PVC 挤出中减少压力波动的解决方案。在 PVC 挤出中经常使用的异向平行锥形双螺杆挤出机，由于腔室的形状，模具内部的压力波动是不可避免的。而且，这些波动可能会降低半成品的质量。Steady flow 模块测量螺杆尖端的压力，并在此基础上不断地重新调整螺杆速度，从而最大限度地减少了压力波动和熔体流动中的波动，以确保显著提高半成品质量并减少废品量。

杰罗德·施莱先生信心十足地表示：“通过我们在展会上的展示，我们将赫然地印证，我们十分了解行业的需求，并且在为相关行业提供解决方案。从优化的单一组件到完整的生产线，包括数字化工具，以促进日常生产，提高各方面的生产效率”。他十分期待在杜塞尔多夫进行许多有意义，尤其是面对面的交谈。

### Complete Lines for the Entire Extrusion Industry

■ For manufacturing virtually all kinds of extruded semi-finished products, batten-



feld-cincinnati offers the right machinery and equipment, from customized single components all the way to optimized turnkey lines. The extrusion specialist based in Bad Oeynhausen, Germany thus serves customers from the pipe, profile and board industries as well as producers of film, sheet and granulates. "The special feature of our complete line is that they not only consist of perfectly synchronized individual components without any interface problems, but also come entirely from a single source", is how the group's Managing Director and CEO Gerold Schley describes its product range's unique selling point. At the K, battenfeld-cincinnati will visualize its complete line competence for the first time by unveiling the new, consistent design of its pipe extrusion lines, this year's winner of the coveted IF Award.

It is only logical, that the top issues of circular economy, digitization and climate protection at this year's leading world trade fair precisely reflects what is on the mind of the entire plastics industry. "Our motto 'Sustainable solutions worldwide' has lost none of its actuality, so we are presenting extrusion equipment in Düsseldorf this year which meets our customers' demands for concepts offering energy efficiency, space-saving footprints, low maintenance, flexibility and high performance", Gerold Schley emphasizes.

#### **Water management and new design for the pipe industry**

At the K, battenfeld-cincinnati will unveil the new complete line standardised design, with which all pipe extrusion lines will be presented from 2023 onwards in the battenfeld-cincinnati corporate colours. Apart from the visual effect, the functionality of the new design is the

#### **Dripper**



most important attractive feature: optimal accessibility and user-friendliness including easy cleaning features are the main attributes. All aggregates starting from the extruder to the calibration and cooling units and the vacuum tank, right up to the cutting saw and the tilt table, are manufactured in-house by battenfeld-cincinnati, perfectly matched not only technically and now also visually, without any interface problems, and integrated into the intuitive-to-operate BCtouch UX control system.

battenfeld-cincinnati offers complete lines for the pipe industry to cover an enormous diversity of applications, ranging from drip irrigation in agriculture right up to large-diameter pipes for water management. Both these extremes will be shown at the K booth. In large-diameter pipes, a new record has actually been set. The first lines to produce pipes up to 2,700 mm in diameter have been delivered. Two highlights of the large-diameter pipe extrusion lines are the pipe die with Optimelt, providing ideal melt homogenization with lowest melt temperatures to minimize sagging. With the completely new constructed 4 m long segments of the downstream unit battenfeld-cincinnati addresses the enormous dimensions of the equipment and the related transport problems. For the first time, there are vacuum tanks and spray baths which come in segments only 4 m long. These single aggregates can easily be transported and are easy to assemble on the production site.

Visitors to the K booth can witness battenfeld-cincinnati's drip irrigation expertise by a video presentation of the new line set up for customer test runs in its technical lab in Bad Oeynhausen. The highlight here are the drippers, which come in a design both simple and inge-

nious to ensure a very even continuous water dispensation. During the extrusion process these drippers, developed by battenfeld-cincinnati with a partner company, are shot through the pipe die and fully welded into the pipe at once while it is still hot. Drilling or punching holes in the drippers for the water outlets are no longer required. At the same time, the design of the drippers ensures a long service life on site without clogging of the water outlets with limescale, soiling or plant growth.

Another novelty at the K booth is the small solEX NG, which completes the high-speed extruder series for pipe extrusion at its smallest size. From now on, the solEX NG 45 will be available in addition to the four solEX NG models already existing in the sizes of 60, 75, 90 and 120 mm. A striking attribute of this series is the combination of internally grooved barrels with a matching special screw geometry, which offers several advantages: up to 40% higher outputs, about 10 °C lower melt temperatures and 15 % less energy consumption.

#### **Ideal extrusion solutions for eco-friendly products**

Floor coverings based on highly filled plastics have experienced enormous growth in recent years. These are often PVC-based formulations. In view of the sustainability discussions, it is becoming apparent that PP will take on a leading role in this area and partially replace PVC. The requirements for floor coverings in terms of absence of tension, flatness and thickness tolerance are extremely high due to the following processing steps, such as printing, as well as the later application area. The semi-crystalline structure of PP makes the task even more difficult.

It turns out, that for the production of environmentally friendly floor coverings made of PP the Multi-Touch roll stack from battenfeld-cincinnati is very suitable. This was clearly demonstrated in practical use by several first customers. This unique roll stack, equipped with up to nine cooling rolls for pre-calibration and re-calibration, ensures a long phase of intense contact between the board and the cooling rolls after the melt has left the flat die. The cooling of the top and bottom side takes place almost simultaneously. In this way, a dimensionally accurate, visually attractive semi-finished product with ideal

flatness and lowest thickness tolerances is created, which is perfect for flooring applications. Yet not only for floor coverings, but also for manufacturing refrigerator panels or other surface panels made of PS or PP, the roll stack is in demand internationally and already being used in many countries. At the K booth, a Multi-Touch roll stack will be exhibited, so that interested customers can exchange views with the relevant specialists about its wide range of applications, which even include the production of thin film smoothed on both sides.

battenfeld-cincinnati also offers perfect extruders for the PVC industry. The most recent proof is the new pelletizing extruder series aglomEX, available either with or without electrically driven shear gap adjustment (EMS). These extruders are suitable not only for virgin material, but also for PCR goods originating, for example, from the Rewindo collection system. The immediate eye-catcher on the model aglomEX 114 to be showcased at the booth is the processing unit lengthened by 6 D, with which all five models have been fitted. In this way, the extruders not only meet the demand of the PVC industry for capacity to process a range of raw materials as wide as possible, but they also achieve up to 20% higher output rates in response to the general call for high efficiency.

### On course towards fully automatic extrusion lines

Automation and digitization not only facilitate daily production processes, but also fulfill the requirements for high efficiency in production, reduced set-up times and low scrap rates. Impressive examples are the systems developed by battenfeld-cincinnati for pipe and sheet production and presented at this year's K. Fast dimension change (FDC) is a system which enables changes of pipe dimensions within a wide range of diameters at the push of a button during production. Not only the melt gap on the pipe die, but also all downstream aggregates adjust themselves simultaneously to the new pipe dimensions without any manual intervention. So, pipe manufacturers are able to fill even small-volume orders efficiently and to minimize the amount of scrap as well, which makes their production eco-friendlier. Similar helpers in daily production are on offer for sheet and board extrusion lines. For instance, combined operation of the extruder and the melt pump in sheet extrusion significantly facilitates start-up. This saves time and costs and minimizes start-up scrap. Automatic adjustment of the flat-sheet die and the roll stack, as well as the roll compensation system, also simplifies the operation and increase the efficiency in production.

At the K, battenfeld-cincinnati will also present Steady flow from its extensive range of individual modules, which is the solution to reduce pressure fluctuations in PVC extrusion. In the counter-rotating conical twin screw extruders frequently used in PVC extrusion, pressure fluctuations inside the die are unavoidable, due to the chamber profile. Yet these fluctuations may degrade the quality of the semi-finished product. Steady flow takes care of measuring the pressure at the screw tip, and on that basis constantly readjusts the screw speed. This minimizes pressure fluctuations and consequently pulsations in the melt flow, which in turn ensures significantly better semi-finished product quality and reduces the amount of scrap. Gerold Schley is confident: "With our trade fair presentation, we will impressively demonstrate that we have understood the needs of the industry and are offering solutions. These range from optimized individual components to complete lines, including digitization tools as well to facilitate daily production and to enhance production efficiency in every aspect". He is looking forward to many interesting and above all face-to-face conversations in Düsseldorf.

► **battenfeld-cincinnati**

[www.battenfeld-cincinnati.com](http://www.battenfeld-cincinnati.com)

**K 2022: Hall 16, Stand B19, FG -CE12**  
**2022K展：16号展厅，B19号展位**

## 在K展会2022上的技术创新—— 为可持续的薄膜生产提高工厂效率

■ 在对抗气候变化的过程中，在可预见的未来，如果没有以节约资源的方式生产的塑料包装，就不可能做到这一点。这就是为什么布鲁克纳机械制造（Brückner Maschinenbau）坚持其雄心勃勃的目标，即除了发展快速发展的循环经济之外，进一步提高薄膜生产效率。这就意味着要减少原材料的使用，将能源消耗降低和在薄膜生产中的“零浪费”。

### 更快更宽的BO工厂

薄膜拉伸线的效率越高，产量越高，单位能耗越低。这些参数主要受生产线速度和宽度的影响。

### BOPP和BOPET：

在BOPP和BOPET这两种最受欢迎的包装薄膜的生产中，迄今为止，生产速度的基准约为600m/min。在K展会2022，布鲁克纳机械制造将展示具有显著更高运行速度的新的生产线概念。

### BOPA：

聚酰胺制成的BO薄膜特别适用于包装油性、高脂肪食品和冷冻食品。对此的需求不断增加，相应的薄膜拉伸线的需求也随之增加。

在K展会，布鲁克纳机械制造将推出新的生产线类型，产量将增加80%——生产速度从220m/min提高到350m/min，生产线的宽度从6.6m扩大到7.4m。

### 电池隔板箔和电容器箔：

在这些部分中，之前（已经不包括）5.5m的生产线宽度逐步增加到6m以上，相关产量增幅超过20%。此外，电容器薄膜的连续拉伸和同步拉伸技术得到了进一步发展：重点是提高薄膜产量和优化薄膜性能，特别是2μm范围内的薄膜。

### 提高薄膜制作可持续性的技术创新

#### 直接回收：

由于一种新型的“直接起绒”，生产过程中产生的边角料和废料可以以更高的百分比直接反馈到挤出过程中，而无需任何再造粒过程。这节省了能源，节



约了原材料，非常接近生产中“零浪费”的目标。

#### 智能拉伸炉管理：

取代以前用于热回收的热交换器，一种专利的、跨越拉伸烘箱所有温度区的节能烘箱控制系统现在可确保每年节能约200kW。

#### 空气动力区分离

该专利工艺保证了整个作业宽度上薄膜的质量更好、更均匀，并保证了生产速度更高。这增加了卷绕机上A级薄膜的比例，减少了生产浪费并降低了单位能耗。

### Technology innovations at K 2022 – Higher Plant Efficiency for Sustainable Film Production

■ In the fight against climate change, it will not be possible to do without plastic packaging that is produced in a way that conserves resources in the foreseeable future. That is why Brückner Maschinenbau is sticking to its ambitious goals for further increasing efficiency in film production in addition to the developments for the rapidly developing circular economy. This means decreasing raw material use, ever lower energy consumption and "zero waste" in film production.

#### Faster and wider BO plants

The more efficient and higher output a film stretching line is, the lower the specific energy consumption. These parameters can mainly be influenced by the line speed and the line width.

**BOPP and BOPET:** In the production of the two most popular packaging films, BOPP and BOPET, the benchmark in production speed has so far been around 600m/min. At K 2022, Brückner Maschinenbau will present new line concepts with significantly higher running speeds.

**BOPA:** BO films made of polyamide are particularly suitable for packaging oily, fatty foods and for frozen foods. The demand for this is continuously increasing and with it the demand for corresponding film stretching lines.

At K, Brückner Maschinenbau will present new line types with up to 80% more output – based on an increase in production speed from 220m/min to 350m/min and a line widening from 6.6m to 7.4m.

**Battery separator foils and capacitor foils:** In these segments, the previous (already exclusive) line width of 5.5m is being increased step by step to over 6m and the associated increase in output of over 20%. In addition, both the sequential and the simultaneous stretching technology for capacitor films were further developed: the focus was on higher film

yield and optimised film properties, especially for films in the 2 µm range.

#### Technical innovations for more sustainability in film production

**Direct recycling:** Thanks to a new type of "direct fluff Ddosing", the edge trimmings and waste produced during production can be directly fed back into the extrusion process in a higher percentage – without any prior re-granulation process. This saves energy, conserves raw material and comes very close to the goal of "zero waste" in production.

**Intelligent stretching oven management:** Instead of the heat exchangers previously used for heat recovery, a patented, energy-efficient oven control system across all temperature zones of the stretching oven now ensures an energy saving of around 200 kW per year.

#### Aerodynamic zone separation

The patented process guarantees even better and more uniform film quality across the entire working width and for ever higher production speeds. This increases the proportion of A-grade film on the winder, reduces production waste and lowers specific energy consumption.

► Brückner Maschinenbau GmbH & Co. KG  
www.brueckner.com

K 2022: Halle 03, Stand C90

K展会2022：3号展厅，C90展位

## 薄膜拉伸线可持续性发展的智能解决方案

■ 在今年的K展会上，布鲁克纳服务技术 (Brückner Servtec) 将展示新的定制转换包 (生产线改造包)，通过转换现有薄膜拉伸生产线上的薄膜类型支持循环经济、降低能耗和提高生产工艺质量的新解决方案，进一步增加了薄膜生产的可持续性。此外，将展示已建立的Brückner ONE数字服务平台的新功能，这将大大方便薄膜拉伸线的维护和操作。

布鲁克纳服务技术的新生产线改造包旨在将现有的薄膜拉伸生产线转换为可持续生产可回收的单材料薄膜类型，如BOPP、BOPA或BOPE。必要转换措施适用于各类生产线，适用于任何时期的生产线。与生产线运营商一起，对工厂进行现场评估，并由此确定转换的具体要求。

⇨ 生产线改造包BOPP-ILC (在线涂层) 可在现有BOPP生产线上生产可回收超高阻隔膜 (UHB)。创新的在线涂层 (ILC) 技术是在薄膜生产过程中直接对塑料薄膜进行湿化学涂层 (水基)。在MD和TD方向之间执行该步骤。纳米级涂层增强了进一步的加工步骤，如金属镀，显著减少了异物含量的使用，从而允许根据欧盟指令94/62/EC生产可回收薄膜。

⇨ 新的BOPP-PE生产线改造包通过LLDPE或HDPE的选择扩展了所有BOPP薄膜拉伸生产线的产品组合。BOPE薄膜具有非常好的机械性能，允许仅在一半厚度上替换PE吹塑薄膜，从而实现完全可回收的单材料结构。必要的改进步骤，通常在挤出、流延单元和MDO区域，根据现场生产线和

情况进行个别调整。

混合式机器设计优化了高产量，为操作员提供了有利于继续以全产量生产BOPP和BOPE薄膜的选择。

⇨ BOPET-PLA生产线改造包，允许生产这种生物基的原料。BOPA薄膜具有优异的透湿性能，具有较高的自然表面张力，可工业上堆肥降解。转换包将挤塑和原料进料领域的所有必要调整与生产高质量和高产量PLA薄膜所必要的工艺技术相结合。

Brückner ONE数字服务产品已在2019年K展会上向全球公众展示，自此以来，已安装在全球350多条生产线上，占可连接资产的近50%。客户受益于全球可用的在线服务模块、备件管理、轻松通信和高级在线文档。所有数据均是通过TÜV Nord体系认证的最高数



据安全性。Brückner ONE的新模块和功能将在今年的K展会上展示：

⇒ 自动语言切换可用于服务模块，并使客户和服务专家能够以其母语轻松对话。一个新的在线AI人工智能程序将所有输入内容自动翻译成用户的首选语言。目前，除英语、汉语、日语、西班牙语或葡萄牙语外，还支持20多种语言的翻译。

⇒ 新的Brückner ONE维护计划助理是进入预防性和预测性维护世界的入口，使服务变得简单、可规划。该系统使用传感器和算法持续检查设备和已安装部件的状况，并在需要维护操作时通知设备操作员。维护计划助理模块方便地指导了用户完成从采购备件到自动创建服务案例和详细维护说明的一系列步骤。该模块旨在扩展到工厂运营商的整个生产链，并可支持上下游组件，如切割机、金属化机、起重机系统等。

⇒ 为了提高薄膜生产的可持续性，布鲁克纳服务技术展示了一系列现代化措施，在提高产量和薄膜质量的同时降低能耗。这显著延长了生产设备的使用寿命。其中包括：

⇒ 直接驱动从挤塑机到缠绕机的所有重要生产线驱动器，以降低功耗，同时，通过优化速度和扭矩控制提高薄膜质量。

⇒ 通过根据薄膜厚度和产量调整智能旋转辊轴的位置，智能地对冷却辊上的水浴薄膜降温。因此，将以下MDO的加热和能源使用降至最低。

⇒ 新的控制系统不仅取代了过时的安全生产硬件，而且还安装了最新的软件，以实现简单、高效和节能的生产线控制。

⇒ 专家审计薄膜制作过程和能源优化

生产线转换包

Line Transformation Package



Brueckner ONE智能服务解决方案

Smart Solutions to Increase the Sustainability of Film Stretching Lines

Brückner ONE Smart Service Solutions

■ At this year's K-show, Brückner Servtec will present new, customized conversion packages (Line Transformation Packages) supporting the circular economy by recycle-ready film types on existing film stretching lines. New solutions for energy reduction and higher quality in the production processes further increase sustainability in film production. In addition, new functions of the established Brückner ONE Digital Service Platform will be shown, which considerably facilitate the maintenance and operation of film stretching lines.

The new Line Transformation Packages from Brückner Servtec are designed for the conversion of existing film stretching lines to the sustainable production of recyclable mono-material film types, such as BOPP, BOPLA or BOPE. The necessary conversion measures are individually adapted to the production line and are avail-

able for lines of any age. Together with the line operator, an on-site evaluation of the plant is carried out and from this the specific requirements for the conversion are identified.

- The Line Transformation Package BOPP – ILC (Inline Coating) enables the production of recyclable ultra-high barrier films (UHB) on existing BOPP production lines. The innovative Inline Coating (ILC) technology is a wet chemical coating (water-based) of plastic films, directly during film production. The step is performed between MD and TD orientation. The nanometer scale coating enhances further processing steps such as metallization, significantly reduces the use of foreign material content and thus allows the production of recyclable films according to EU Directive 94/62/EC.

- The new Line Transformation Package





BOPP – PE extends the product portfolio of all BOPP film stretching lines by the option LLDPE or HDPE. BOPE films have very good mechanical properties, allow replacement of blown film PE on only half of the thickness, and thus enables mono-material structures which are fully recyclable. The necessary modification steps, typically in the extrusion, casting unit and MDO areas, are individually tailored to the line and situation on site.

The hybrid machine design, optimized for high output, offers operators the choice of continuing to produce BOPP at full output as well as BOPE film profitably.

- The Line Transformation Package BOPET – PLA allows the production of this biobased raw material. BOPLA films offer excellent moisture transmission properties, have a high natural level of surface tension and are industrially compostable. The conversion package combines all necessary adjustments in the field of extrusion and raw material feeding with the necessary process know-how to produce PLA films in high quality and at high output.

The Brückner ONE digital service products were presented to the global public at the K 2019 and since then have been installed in more than 350 production lines worldwide, representing almost 50% of connectable assets. Customers benefit from the globally available online modul-

es for services, spare parts management, easy communication, and advanced line documentation. All at highest data security certified by TÜV Nord. New modules and functions for Brückner ONE will be presented at this year's K show:

- Automatic language switching is available for the service module and enables easy conversations of customers and service specialists in their native language. A new online AI routine automatically translates all input into the user's preferred language. Currently, more than 20 languages are supported in addition to English, Chinese, Japanese, Spanish or Portuguese.

- The new Brückner ONE Maintenance Plan Assistant is the entry into the world of preventive and predictive maintenance and makes service easy and plannable. The system uses sensors and algorithms to continuously check the condition of the plant and installed components and informs the plant operator as soon as a maintenance action is necessary. The Maintenance Plan Assistant module guides the user conveniently through a range of steps from the procurement of spare parts to the automatic creation of a service case and detailed maintenance instructions. The module is intended to be expandable to the plant operator's entire production chain and can support up- and downstream components such as

slitters, metallizers, crane systems and more.

To increase the sustainability of film production, Brückner Servtec is showing a wide range of modernization measures that reduce energy consumption while increasing output and film quality. This significantly extends the lifecycle of production equipment. Among others these are:

- Direct drives for all significant line drives from extrusion to winder to reduce power consumption while improving film quality through optimized speed and torque control

- Smart Swivel Roll intelligently cools the film in the water bath at the chill roll by adjusting its position based on film thickness and output. Thus, reducing the heating – and energy use – at the following MDO to a minimum

- New Control Systems not only replace obsolete hardware for production safety but moreover install latest software for an easy, efficient and energy saving line control

- Expert audits for process and energy optimization in film production

► **Brückner Servtec GmbH**

[www.brueckner-servtec.com](http://www.brueckner-servtec.com)

**K 2022: Hall 3, Stand C90**

**K展会2022：3号展厅，C90展位**

## 可持续和数字化

■ 凯孚尔 (KIEFEL) 将于10月19日至26日在今年的K展览会上展示加工可回收材料的机器、工具和自动化解决方案，并进行现场演示。该公司还将在3号展厅E90展位上展示新的数字服务、医疗和制药行业解决方案以及可持续性主题的研究活动。此外，凯孚尔还将在VDMA Dome的“The Machine”中提供关于结束周期流程的见解。

“在凯孚尔，我们关注于数字化和可持续发展的大趋势，”凯孚尔可持续发展主管Cornelia Frank解释，“这就是为什么我们特别高兴能在本届K展示会上展示解决方案，这些解决方案与今年的循环经济、数字化和气候保护等重点主题绝好地匹配了。”

### 来自单一供应商的可持续包装解决方案

除了传统的生物基和再生塑料，凯孚尔钢尺和倾斜机也可以处理纸张。在KMD 78.2高速钢尺机的现场演示中，该公司将演示如何使用回收薄膜制作高质量、可持续的包装产品，从而为托盘到托盘回收做出贡献。这是通过内部独特的工具技术和智能自动化概念实现的。凯孚尔将在K展会推出新的凯孚尔标准自动化 (KSA)。除了客户专用的自动化解决方案之外，该公司还为最常见的应用提供基于积木原理的完全模块化标准自动化。

此外，参观者还可以了解更多有关凯孚尔最新包装技术的信息，即天然纤维的纤维热成型，这在全球范围内需求

量很大。部署该技术的NATUREFORMER KFT 90机器已在全球范围内投入使用。在K展会2022，KFT Lab实验室机器将用于说明该技术的生产过程和适用于食品和非食品的应用。凯孚尔拥有自己的材料和技术中心，为概念验证提供了广泛的能力，这也将成为其特色。

### 促进更佳循环经济的研 究活动

凯孚尔致力于以多种方式提高可持续性，并已将这一点纳入其公司战略，获得了埃科瓦迪斯 (EcoVadis) 认证，并参与了各种旨在改善循环经济的研究计划。在展位上，参观者将深入了解HolyGrail 2.0、PrintCYC和NextLoop等项目的研究活动和成果。



KMD 78.2钢尺机是一种高效、全面的机器，能够处理再生薄膜（所有图片：©凯孚尔有限公司（KIEFEL GmbH））

*The KMD 78.2 steel rule machine is an efficient all-rounder – and is capable of processing recycled film (All pictures: © KIEFEL GmbH)*

**服务：机器状态和维护一目了然——24/7**

在凯孚尔的售后部门，数字服务的范围已经扩大。凯孚尔门户是一个中心化的在线平台，允许客户使用“维护仪表盘”24小时监控其机器状态，并计划即将进行的维护。此外，还通知用户适当的机器升级信息。凯孚尔门户还可用于识别和请求机器备件、3D机器文档和机器操作所有方面的新交互式在线培训课程。

**医疗和制药：生产生物培养袋**

同时，凯孚尔正在为医疗和制药行业提供创新。在K展示会上，公司将展示其具有必要机器技术的生物培养袋的扩大产品组合。3D和2D袋可以由无PVC材料制成，如PE或PP，或，由

PVC或EVA制成，具体取决于客户的要求。根据客户要求，可实施多种选择，例如，半自动或全自动机器，用于储存干细胞、细胞培养、混合或分离的一次性袋，2D或3D设计或软管/端口连接组件。

**Sustainable and Digital**

■ KIEFEL will be presenting machine, tool and automation solutions for processing recyclable materials at this year's K trade fair with live demonstrations. The company is also showcasing new digital services, solutions for the medical and pharmaceutical industries and research activities on the topic of sustainability in

Hall 3, Stand E 90. In addition, Kiefel is offering insights into processes for closing the cycle at "The Machine" in the VDMA Dome.

"At Kiefel, we keep our eyes on the megatrends of digitization and sustainability," explains Cornelia Frank, Head of Sustainability at Kiefel. "That's why we are particularly pleased to be presenting solutions at this K trade fair that ideally match this year's focal topics of circular economy, digitization and climate protection."

**Sustainable packaging solutions from a single source**

As well as classic, bio-based and recycled plastics, Kiefel steel rule and tilting ma-

凯孚尔（Kiefel）机器可以生产各种由传统塑料、生物基塑料或回收塑料制成的包装

*Kiefel machines can produce a wide range of packaging made from classic, bio-based or recycled plastics*

在K展会2022，凯孚尔还将介绍纤维技术和天然纤维热成型的潜在应用

*At the K 2022, Kiefel will also be presenting fiber technology and the potential applications of thermoforming with natural fibers*

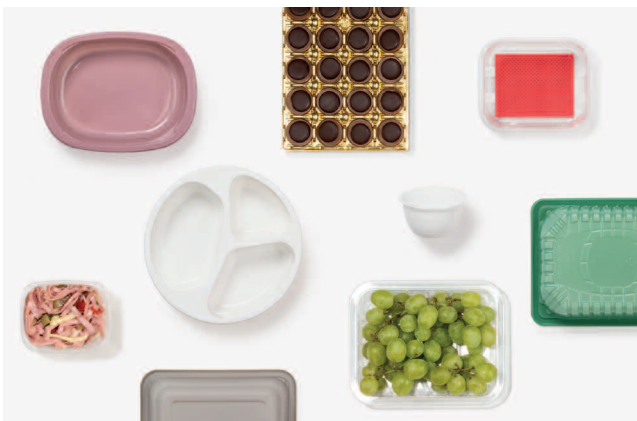



chines can also process paper. In live demonstrations of the KMD 78.2 Speed steel rule machine, the company will illustrate how high-quality, sustainable packaging products are made from recycled film – thus making a contribution to tray-to-tray recycling. This is made possible by in-house, unique tool technology and smart automation concepts. Kiefel is unveiling the new Kiefel Standard Automation (KSA) at the K. Beside customer-specific automation solutions, the company thereby offers completely modular standard automations based on a building block principle for the most common applications.

In addition, visitors can discover more about the latest packaging technology from Kiefel, fiber thermoforming of natural fibers, which is in high demand worldwide. Large numbers of the NATUREFORMER KFT 90 machine, which deploys this technology, are already operational worldwide. At the K 2022, the KFT Lab laboratory machine will be used to illustrate the production process and suitable food and non-food applications for the technology. With its own material and technology centers, Kiefel offers extensive capabilities for proofs-of-concept, which will also be featured.

#### **Research activities for a better circular economy**

Kiefel is committed to increased sustainability in many ways, and has anchored this in its corporate strategy, is EcoVadis-certified and is involved in various re-

最近，凯孚尔推出了用于生产2D或3D生物培养袋的机器解决方案

*Recently Kiefel launched machine solutions for the production of 2D or 3D bioprocess bags*



search initiatives for a better circular economy. At the booth, visitors will gain an insight into new research activities and results from initiatives such as HolyGrail 2.0, PrintCYC and NextLoop.

#### **Service: Machine status and maintenance at a glance – 24/7**

In Kiefel's After Sales division, the range of digital services has been expanded. The Kiefel Portal is the central online platform that allows customers to keep an eye on their machine status around the clock using the "Maintenance Dashboard" and plan upcoming maintenance. Furthermore, users are also informed about suitable machine upgrades. The Kiefel portal can also be used to identify and request machine spare parts, 3D machine documentation and new interactive online training courses on all aspects of machine operation.

#### **Medical & Pharma: Production of Bioprocess Bags**

Simultaneously, Kiefel is presenting innovations for the medical and pharmaceutical industry. At the K trade fair, the company is exhibiting its expanded portfolio of bioprocess bags with the requisite machine technology. The 3D and 2D bags can be made from PVC-free materials such as PE or PP, or from PVC or EVA, depending on the customer's requirements. Depending on the customer's requirements, a wide range of options can be implemented, e.g. semi-automatic or fully automatic machines, disposable bags for the storage of stem cells, cell cultures, mixing or separation, in 2D or 3D designs or hose/port connection components.

➔ KIEFEL GmbH

[www.kiefel.com](http://www.kiefel.com)

**K 2022: Hall 3, Stand E 90**

**K展会2022：3号展厅，E90展位**

## 以可持续发展为成功驱动力，受益于数字化，提高生产效率

■ 莱芬豪舍集团将在世界领先的塑料加工贸易展览会 K 2022 上安排四个展位。在今年的莱芬豪舍座右铭“此时此刻”，挤出专家将向薄膜和非织造布生产商展示三大行业主要的有价值的解决方案主题：可持续性、数字化和生产效率。

莱芬豪舍集团首席执行官 Bernd 莱芬豪舍解释说：“世界和我们的行业正面临着重大挑战。在许多主题上存在不确定性、迷失方向和悬而未决的问题。但他们不会容忍任何延误。现在是采取行动、将挑战转化为机遇的时候了。我们

拥有这方面的专业知识以及在我们的行李箱中立即适用的出色解决方案，我们使我们的客户和合作伙伴能够做到这一点。”

莱芬豪舍集团将在杜塞尔多夫的三个自己的展位和一个联合展位上展出。大约 1,200 平方米的主展位位于 17 号展厅 (C 22)，展示了莱芬豪舍吹塑薄膜、流延片材涂覆和 Reicofil 业务单元。借助机器展示、视觉展示和最终产品的具体解决方案，参观者将了解他们如何经济地制造完全可回收的产品、安全地处理回收物、增加产量以及在不依

赖系统的情况下将整个生产联网、专家或制造商。为确保即使在购买后也能顺利生产，莱芬豪舍 Service 向客户展示了如何充分利用他们的莱芬豪舍产品，并通过返工解决方案、修改、培训计划和数字服务提高他们的生产力。

莱芬豪舍 Extrusion Systems 业务部门的组件专家还将在另外两个展位上展示他们的产品组合。在 11 号展厅 (C16) 中，一切都围绕着螺杆、机筒和挤出机进行 - 为什么，特别是对于加工回收材料，高性能磨损保护对于可靠性和高经济效益至关重要。著名的用于螺

杆和机筒的莱芬豪舍Reiloy 磨损保护合金在独立测试中多次获得最高值，证明投资于高质量的磨损保护是有回报的。在 1 号展厅 (D91)，莱芬豪舍挤出系统将展示其在扁平模头和共挤模块方面的创新，以及它们完美协调的相互作用，以实现最高生产效率。

除了自己的展位外，莱芬豪舍还将作为 R-Cycle 倡议的合作伙伴出席被称为循环经济论坛 (CE 07) 露天场地联合展馆的一部分。R-Cycle 是各个科技公司和组织在塑料包装全生命周期的合作项目。跨学科团队为可持续塑料包装开发了一个开放的可追溯性标准，通过提供数字产品护照，使回收相关信息透明化。这使废物分类设施能够更准确地识别可回收包装并形成易于回收的单一品种部分。这是获得高质量回收物以建立运转良好的循环经济的基础。

参观莱芬豪舍展位的参观者的一个特别亮点是有机会额外参加 10 月 20 日、21 日和 24 日在莱芬豪舍技术中心举行的内部展览。为此，莱芬豪舍组织了免费穿梭巴士，往返于杜塞尔多夫展会和距离仅约 70 公里的特罗斯多夫的莱芬豪舍总部。在这里，客人可以在每天两次主持的现场演示中体验各种正在运行的吹膜和平板薄膜生产线。有兴趣的人士可以联系他们的莱芬豪舍代表询问参与情况。



### Using Sustainability as a Success Driver, Benefiting from Digitalization, Increasing Productivity

■ The Reifenhäuser Group will be represented with four booths at the world's leading trade fair for plastics processing, K 2022. Under this year's Reifenhäuser motto "The Time is Now", the extrusion specialists will show producers of films and nonwovens valuable solutions for the three major topics of the industry: sustainability, digitalization and productivity. Bernd Reifenhäuser, CEO of the Reifenhäuser Group, explains: "The world and our industry are facing major challenges. There is uncertainty, disorientation and

unanswered questions on many topics. And yet they will not tolerate any delay. Now is the time to act and turn challenges into opportunities. We have know-how for this as well as great, immediately applicable solutions in our luggage, with which we enable our customers and partners to do so."

The Reifenhäuser Group will be represented at three of its own booths and one joint booth in Duesseldorf. The main booth with approximately 1,200 square meters is located in Hall 17 (C 22) and showcases the Reifenhäuser Blown Film, Cast Sheet Coating and Reicofil business units. With the help of machine exhibits, visual presentations and concrete solutions for end products, visitors will learn, among other things, how they can manufacture fully recyclable products economically, process recyclates safely, increase their output and network the entire production without becoming dependent on systems, specialists or manufacturers. To ensure smooth production even after purchase, Reifenhäuser Service shows how customers can get the best out of their Reifenhäuser products and increase their productivity with rework solutions, modifications, training programs and digital services.

The component specialists of the Reifenhäuser Extrusion Systems business unit will additionally present their portfolio at two other exhibition booths. In Hall 11 (C16), everything revolves around screws, barrels and extruders – and why, especially for processing recycled material, high-performance wear protection is essential for reliability and high economic efficiency. The well-known Reifenhäuser Reiloy wear protection alloys for screws and barrels have repeatedly achieved top values in independent tests, proving that investing in high-quality wear protection pays off. In Hall 1 (D91), Reifenhäuser Extrusion Systems will showcase its innovations for flat dies and coextrusion blocks and their perfectly coordinated interaction for maximum productivity.

In addition to its own booths, Reifenhäuser will also be present as a partner of the R-Cycle initiative as part of a joint pavilion on the open-air site in the so-called Circular Economy Forum (CE 07). R-Cycle is a cooperation project of various technology companies and organizations along the entire life cycle of plastic packaging. The interdisciplinary team has developed an open traceability standard for sustain-



Bernd Reifenhäuser,  
莱芬豪舍集团CEO

CEO of the Reifenhäuser Group

able plastic packaging that makes recycling-relevant information transparent by providing a Digital Product Passport. This enables waste sorting facilities to more precisely identify recyclable packaging and form recycling-friendly and single-variety fractions. This is the basis for obtaining high-quality recyclates to build a functioning circular economy.

A special highlight for visitors to the Reifenhäuser trade fair booths is the opportunity to additionally participate in the in-house exhibition on October 20, 21 and 24 at the Reifenhäuser Technology Center. For this purpose, Reifenhäuser organizes a free bus shuttle between the Duesseldorf trade fair and the Reifenhäuser headquarters in Troisdorf, which is only about 70 kilometers away. Here, the guests can experience various blown film and flat film lines in operation during two moderated live demonstrations per day. Interested parties can contact their Reifenhäuser representative to inquire about participation.

► Reifenhäuser Group  
reifenhäuser.com

K 2022:

莱芬豪舍主展台(吹膜, 平膜, 无纺布生产线, 服务, 数字化, 零部件): Hall 17 / C 22

莱芬豪舍螺杆, 机筒和挤出机: Hall 11 / C16

莱芬豪舍平模头: Hall 1 / D 91

R-Cycle: 循环经济论坛 (CE 07)

Reifenhäuser main booth (blown film, flat film, nonwovens lines, service, digitalization, components):  
Hall 17 / C 22

Reifenhäuser screws, barrels and extruders: Hall 11 / C16

Reifenhäuser flat dies: Hall 1 / D 91

R-Cycle: Circular Economy Forum (CE 07)



### 循环经济：数字化起决定性作用

■ 我们都知道：废弃塑料实际上是原材料。然而，这并不能改变事实，即这些废物中有被回收的太少了并返回到物料循环中。在K展会2022上，克劳斯玛菲 ( KraussMaffei ) 不仅将展示必要的机械设备，还将展示新的数字解决方案，以实现能源消耗和碳足迹方面的最大节约。

特别是在医疗保健领域，全球对一次性用品的需求巨大。通常情况下，这些产品仅在短时间内使用，并表现出轻微的污染。对于随后将它们用作设计用于使用寿命更长的部件的原材料，这些将是理想条件。例如，在克劳斯玛菲的展台，参观者将能够亲眼看到胰岛素笔帽如何被转换成汽车车门模块。

#### 在K展会2022上的材料循环：从胰岛素笔帽到汽车车门模块

感兴趣的参观者可以现场体验整个过程：全电动PX 200-1400使用医用聚丙烯原材料生产96个胰岛素笔帽。切碎后，这些盖用作ZE28 BluePower双螺杆挤出机上进行的上循环过程的基础材料。这里，添加、混合和均匀化各种添加剂，例如，粘合剂和液体颜料。所产生的稀土化合物被转移到下游注塑机——更准确地说，转移到新的 power Molding 1300-11900机型中。这一新开发的系列是基于经验证的双压板技术，该技术在一系列高度标准化的选项中脱颖而出，并被设计为具有成本效益的变体，特别是用于接近标准的应用。

#### 减少碳足迹，降低能源成本，符合强烈的环保意识

在K展会2022克劳斯玛菲展台上展



SocialProduction系列能够对机器和生产过程进行与位置和时间无关的监测。

*The socialProduction family enables location and time-independent monitoring of machinery and production processes*

示的应用程序中，记录并显示了所有与可持续性相关的过程数据，因此与使用原始材料相比，回收过程节省的二氧化碳量在任何时候都是显而易见的。

例如，与摩丹 ( Motan ) 一起开发了一个应用程序，显示每个工艺步骤的能耗。该应用程序使处理器能够专门记录并改善其能耗。数字ACPlus解决方案经过优化，现在更好地适应再生材料的处理。由于在注塑过程中自动重新调整环境条件，如温度或空气湿度，因此减少了生产废料。在机器启动期间，也可以更快地达到标称工艺值，从而大大降低启动废料。dataXplorer通过实时捕获多达500个机器信号，用于碳足迹测量，从而提供深入的过程数据。因此，可以立即检测到与预定义公差范围的任何偏差。

#### Circular Economy: Digitalization Makes the Decisive Difference

■ We all know it: waste plastics are actually raw materials. However, this does not change the fact that far too little of this waste is recycled and returned into the material cycle. At K 2022 KraussMaffei will not only exhibit the necessary machinery, but also new digital solutions that enable maximum savings to be achieved in terms of energy consumption and carbon footprint.

Especially in the healthcare sector, the worldwide demand for disposables is enormous. Very often the products are only used for a short time and exhibit minor contamination. These are ideal

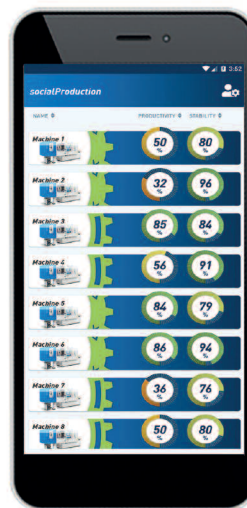

使用socialProduction选项时，可使用智能手机应用程序和PC或平板电脑的网络应用程序。

*Both, a smartphone app and a web application for PC or tablet are available for the use of the socialProduction option*

conditions for subsequently using them as raw materials for components designed for a longer service life. At the KraussMaffei booth, visitors will be able to see for themselves how insulin pen caps are converted into door modules for cars, for example.

### Material cycle at K 2022: from insulin pen caps to automotive door modules

Interested visitors can get a live experience of the entire process: A fully electric PX 200-1400 produces 96 insulin pen caps per shot from medical polypropylene virgin material. After shredding, these caps serve as base material for the up-cycling process carried out on the ZE28 BluePower twin-screw extruder. Here, various additives such as bonding agents and liquid pigments are added, mixed and homogenized. The resulting re-compound is transferred to the downstream

injection molding machine – more precisely to the new powerMolding 1300-11900. This newly developed series is based on the proven two-platen technology that stands out for a range of highly standardized options and is designed as cost-effective variant in particular for nearly standard applications.

### Reduced carbon footprint and lower energy costs in line with a strong environmental conscience

With the application shown at the KraussMaffei booth at K 2022, all sustainability-relevant process data are recorded and displayed, so that the amount of CO<sub>2</sub> saved by the recycling process as compared to the use of virgin material is evident at any time.

Together with Motan, for instance, an application has been developed that shows the energy consumption of each process step. This application enables processors

to specifically record and improve their energy consumption. The digital ACPplus solution has been optimized and is now better adapted to the processing of reclaimed material. It reduces production scrap thanks to the automatic re-adjustment to changing ambient conditions such as temperature or air humidity during the injection molding process. During machine start-up as well, the nominal process values are achieved much faster, which results in substantially lower start-up scrap. The dataXplorer provides in-depth process data by capturing up to 500 machine signals in real time for the carbon footprint measurement. Any deviations from the pre-defined tolerance ranges can thus be detected instantly.

### ► KraussMaffei

[www.kraussmaffei.com](http://www.kraussmaffei.com)

K 2022: Hall 15, Stand C15/C24-D24

K展会2022：15号展厅，C15/C24-D24 展位

## 为包装和地毯行业提供 更少的能源、更少的材料和循环性

■ 在2022 K展，米弗机械 (MEAF Machines) 将展示其挤出解决方案。由于其高效的设计，米弗的挤出方案比许多竞争对手的碳足迹少30%至65%，同时允许进一步减少原材料使用。此外，其内置的灵活性使米弗的挤出机可以使用几乎任何热塑性材料，包括生物聚合物和回收材料，如瓶片和消费后再研磨料，从而帮助塑料加工商走向“绿色”。

食品包装行业的制造商面临巨大压力，需要减少塑料用量，同时仍保持食

品安全、吸引力和可回收性。通过与瑞士制造商普罗米克斯解决方案 (Promix Solutions) 合作，米弗公司为其挤出生产线增加了物理发泡能力，允许进一步减少材料使用和降低重量，而不会影响产品的堆叠性和强度等特性。由于使用氮气而不是常用的丁烷和丙烷，该工艺几乎不对环境造成影响。

地毯和人造草坪行业是最近才开始走向“绿色”未来的行业。其中，之前它们将使用不可回收材料，如沥青和乳

胶，但现在他们正在考虑将热塑性弹性体 (TPE) 和TPU用于地毯背衬，以使其产品完全可回收利用，而不是被焚化或最终填埋。然而，这需要生产过程中的重大转变和许多地毯制造商有新的思维方式，米弗公司为各种地毯背衬解决方案调整其内部挤出测试线的原因。

能源和材料效率一直是米弗设计理念的核心。这有助于该公司在可靠能源和原材料价格昂贵的偏远地区获得立足点。“这是一家相对较小公司的优势。”

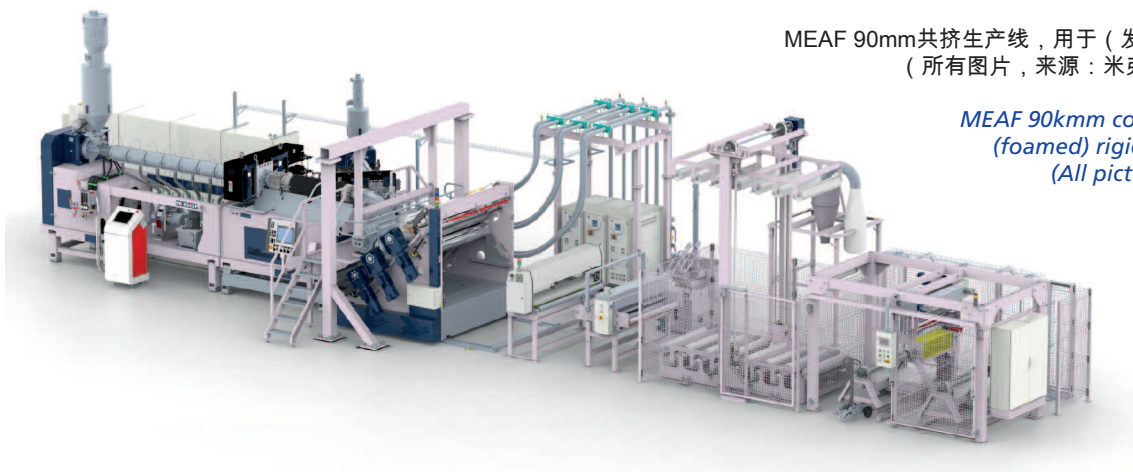

MEAF 90mm共挤生产线，用于（发泡）硬质板材生产  
（所有图片，来源：米弗公司 (MEAF)）

MEAF 90kmm co-extrusion line for  
(foamed) rigid sheet production  
(All pictures, source: MEAF)



PET和PP物理发泡托盘由米弗挤出生产线生产的片材制成

*PET and PP physical foamed trays from sheet made on MEAF extrusion line*



米弗机械公司 (MEAF Machines BV) 董事Elwin Houtekamer说,“我们比大型制造商更灵活,与专业创新供应商平等合作。因此,我们始终处于挤出技术的前沿。”

### *Less energy, less material and circularity for the packaging and carpet industries*

■ At K2022 MEAF Machines will demonstrate its extrusion solutions.

Thanks to its highly efficient design, MEAF's extrusion have a 30 to 65% smaller carbon footprint than many of its competitors while allowing for a further reduction in raw material use. In addition its in-built flexibility allow MEAF's extruders to work with almost any thermoplastic material, including biopolymers and recycled materials like bottle flakes and post-consumer regrind, thus helping plastics processors to go 'green'.

Manufacturers in the food packaging sector are under huge pressure to reduce the amount of plastics used, while still maintaining food safety, attractiveness and recyclability. By partnering with Swiss manufacturer Promix Solutions, MEAF has added physical foaming capabilities to its extrusion lines. This allows for a further reduction in material use and lower weight, without compromising on features such as stackability and strength. Thanks to the use of nitrogen rather than the often used butane and propane, the process has almost no environmental impact.

An industry sector which only recently has started to move towards a 'greener' future is the carpet and artificial turf sector. Where previously they would use non recyclable materials like bitumen and latex,

they are now looking at switching to thermoplastic elastomers (TPE) and TPU for their carpet backing to allow for their products to become fully recyclable rather than being incinerated or ending up in a landfill. This however requires a considerable switch in the production process and a new way of thinking for many carpet manufacturers, reason for MEAF to adjust its in-house extrusion test line for various carpet backing solutions.

Energy and material efficiency have always been at the heart of MEAF's design philosophy. This has helped to company to gain a foothold in far-away places where reliable energy and raw materials come at a premium. "That is the advantage of being a relatively small company," says Elwin Houtekamer, Director at MEAF Machines BV. "We are more agile than the big manufacturers and work as equal partners with specialised innovative suppliers. This way we are always at the forefront of extrusion technology."



人造草坪是另一种产品,米弗可以为其提供挤出生产线,以生产可回收背衬

*Artificial grass is another product for which MEAF can provide an extrusion line to produce recyclable backing*

➡ MEAF Machines

[www.meaf.com](http://www.meaf.com)

**K 2022: Hall 17, Stand A22**

**K展会2022: 17号展厅, A22展位**

## 全系列植物基聚合物添加剂

■ 帕斯嘉 (Palsgaard) 将利用德国杜塞尔多夫2022 K展的机会,将自己定位为聚合物生产商、母料制造商、寻求降低碳足迹和实现可再生能源制造商的首选供应商。在世界最大的塑料交易会上,帕斯嘉将展示其完整的可持续聚合

物添加剂组合,并提供新发展的第一手见解。

“随着塑料行业从线性经济向循环经济转型,对传统化石配方产品可再生替代品的需求快速增长,”帕斯嘉特种生物添加剂全球业务总监Ulrik Aunskjær

说。“除了更基本的原料之外,这也适用于功能性添加剂,其中普通合成化学面临越来越大的监管压力,而消费者也要求在其产品包装的聚合物中加入更多天然、安全和健康的成分。在帕斯嘉,我们正在通过全系列植物基食品级聚合物



添加剂解决来这些问题，由高级客户和应用程序支持来提供支持。”

在包装塑料中，帕斯嘉的Einar®添加剂用作高效防雾和防静电表面活性剂、分散助剂、老化改性剂、EPS涂料和脱模剂。在2022 K展上，该公司将在其不断增长的产品组合中引入新的基于植物的创新技术，这些创新由位于丹麦的帕斯嘉聚合物应用中心开发、优化，以帮助客户在不影响性能或质量的情况下，领先于日益严格的法规，如食品接触材料法规。所有这些产品都是现有聚合物配方中基于化石添加剂的最佳替代品，并且非常适合新的负责任包装解决方案。

此外，帕斯嘉还将向2022 K展的访客介绍其聚合物添加剂业务未来的重大投资。该公司碳中和生产能力的扩张正按计划进行。在2020年，已成功调试了一条新的乳化剂颗粒生产线，生产能力为10,000吨，其后，尤尔斯明纳现场将安装最先进的喷淋塔，预计该喷淋塔将于2023年第四季度投入运行，并为帕斯嘉现有的喷淋能力增加30,000吨。这将由多个新的反应、蒸馏和酯化工厂补充，到2024年，公司的总产能将翻一倍。

此外，在巴西、美国和中国的新销售办事处将加强对这些地区客户的支持，因为帕斯嘉正在实施其发展长期密切合作伙伴关系的战略，并提高其全球服务能力。

### Full Range of Plant-Based Polymer Additives

■ Palsgaard will take the opportunity of K 2022 to position itself as a preferred supplier to polymer producers, masterbatch manufacturers and compounders seeking to lower their carbon footprint and go renewable. At the world's largest plastics trade fair Palsgaard will present its complete portfolio of sustainable polymer additives and offer first-hand insight in new developments.

“As the plastics industry is transforming from a linear to a circular economy, there is a fast-growing demand for renewable alternatives to conventional fossil-based formulations,” says Ulrik Aunskjær, Global Business Director, Bio Specialty Additives at Palsgaard. “Beyond the more



Einar®聚合物添加剂是基于植物的食品级添加剂，可用于PE和PP的多种应用场景，如防静电添加剂、防雾添加剂、防污添加剂、颜色分散助剂和脱模添加剂（照片：帕斯嘉有限公司）

*Einar® polymer additives are plant-based and food-grade and can be used for a variety of applications in PE and PP, such as anti-static additives, anti-fogging additives, anti-fouling additives, colour dispersing aids and mould release additives (Photo: Palsgaard A/S)*

basic raw materials feedstock, this also applies to functional additives, where common synthetic chemistry is under increasing regulatory pressure while consumers demand more natural, safe and healthy ingredients also in the polymers in which their products are packaged. At Palsgaard, we are addressing these issues with a full range of plant-based, food-grade polymer additives, backed by advanced customer and application support.”

In packaging plastics, Palsgaard's Einar® additives serve as highly effective anti-fog and anti-static surfactants, dispersing aids, ageing modifiers, EPS coatings and mould release agents. At K 2022, the company will introduce new plant-based innovations in its growing portfolio, developed and optimised at Palsgaard's Polymer Application Centre in Denmark to help customers stay ahead of increasingly stringent regulations, such as on food-contact, without compromising performance or quality. All of these products provide an excellent drop-in replacement for fossil-based additives in existing polymer formulations and have a perfect fit in new responsible packaging solutions. Furthermore, Palsgaard will also update

K 2022 visitors on significant investments made into the future of its polymer additives business. The expansion of the company's carbon-neutral production capacity is proceeding as scheduled. After the successful commissioning of a new emulsifier pellet line with a capacity of 10,000 tonnes in 2020, the Juelsminde site will receive a state-of-the-art spray tower, which is expected to go on-stream in the fourth quarter of 2023 and add 30,000 tonnes to Palsgaard's existing spray capacity. This will be complemented by multiple new reaction, distillation and esterification plants, altogether doubling the company's overall production capacity by 2024.

In addition, new sales offices in Brazil, the United States and China will strengthen the support of customers in these regions, as Palsgaard is delivering on its strategy to develop long-term close partnerships and grow its global service capacities.

► Palsgaard A/S  
www.palsgaard.com/polymers  
K 2022: Hall 7, Level 1, Stand D20  
K展会2022：7号展厅，1楼，D20展位



## K展会2022提供的主题、活动和亮点一瞥

Lucrèce Foufopoulos, 聚烯烃、循环经济和新技术执行副总裁

Manfred Hackl, 埃瑞玛集团股份有限公司 (EREMA Group GmbH) 首席执行官 (图片资料来源: 埃瑞玛集团股份有限公司)

*Lucrèce Foufopoulos, EVP Polyolefins, Circular Economy and Innovation & Technology, Manfred Hackl, CEO EREMA Group GmbH (Photocredit: EREMA Group GmbH)*



■ 杜塞尔多夫的K展会2022即将到来, 准备工作正在全面展开。6月13日, 埃瑞玛集团 (EREMA Group) 和北欧化学 (Borealis) 邀请了国际塑料和回收行业刊物的代表前往上奥地利州, 对该公司将在K展会2022上展示的技术发展和灯塔计划进行预演。K展会预热活动的地点是位于安斯费尔登市的埃瑞玛公司总部。

“我们的使命是‘用心呵护, 赋能塑料新生命’, 这也是我们在今年展会上的口号。这突出了埃瑞玛集团将向塑料行业内部人士和展会的所有其他参观者展示的内容: 如果价值链中的每个人都共同努力, 就有可能实现循环经济,”埃瑞玛集团公司 (EREMA Group GmbH) 首席执行官Manfred Hackl在开幕式上说到。

在杜塞尔多夫, 埃瑞玛集团的子公司——埃瑞玛 (EREMA)、纯净循环 (PURE LOOP)、优玛科 (UMAC)、3S、关键回收 (KEYCYCLE) 和等离子体 (PLASMATIC) 将首次在集团展台上展示他们的技术创新、服务和支持。将介绍七种新的回收系统和组件, 使大型工厂的生产能力达到6 t/h, 同时, 在回收物质量和工艺稳定性方面树立里程碑。这是因为塑化装置的技术创新, 专门为低比能耗的高产量而开发, 新的EREMA 406激光滤光片具有50%的更大的筛选面积, 以及将在K展会2022推出并在BluPort®客户平台上提供的新数字

辅助系统。例如, 这些包括PredictOn应用程序, 它有助于根据机器数据的连续测量和评估来预测和消除即将发生的故障。

“CHEMAREMA是我们为机械材料加工开发的新系列, 作为化学回收过程的一部分,”Hackl在介绍另一项EREMA创新技术时说到。机械工艺通常处于化学循环工艺链的开端, 以制备输入串流, 并确保进料的可靠、连续和节能流动。CHEMAREMA采用的挤塑技术能够适应应用要求, 并为下游化学工艺进行精确设计。

对于寻求简单应用的快速可用回收系统的客户, 埃瑞玛集团子公司优玛科在K展会2022有了一项创新技术。该公司目前专注于翻新和交易以前拥有的设备, 将扩大其业务领域并在杜塞尔多夫推出READYMAC, 一项标准化的预制回收解决方案, 可根据成熟的EREMA TVE技术从库存中进行生产。

最后, 在内部回收领域, 纯净循环公司和等离子体公司将通过其产品组合完善集团公司提供的种类繁多的机器。

在K展会的室外区域, 埃瑞玛将与合作伙伴一起通过现场演示。为此目的, 处理不同的废物流。“可回收物制造的产品”展览将展示各种高质量的可回收物应用, 从技术部件到消费品和食品包装。

在埃瑞玛集团, 在K展会2022年之前, 其预期已经处于较高水平。“循环经

济已经成为塑料行业的一个大话题, 即使是塑料废物, 尽管这在几年前是不可想象的。这一推动证实了我们在过去几年中所做的工作。还有很多工作要做, 但价值链中的所有参与者现在都朝着同一方向努力。这将在今年的K展会上看到、感受到,”Manfred Hackl说。

**北欧化学——加速向更循环的未来过渡:** 北欧化学致力于通过创新推动行业循环转型, 实现可持续的业务增长。K展会2022的主题“创新, 合作, 加速”强调了与全球合作伙伴更紧密合作的必要性, 以生产基于聚烯烃的差异化解决方案, 使整个社会循环的、现代化的生活成为可能。实现从今天的线性系统到明天的循环系统的巨大转变需要整个价值链的创新、协作和加速。

北欧化学致力于利用其专业知识和全球影响力推进塑料循环经济。在6月13日举行的K展会2022预热的联合启动仪式上, 北欧化学提供了他们的综合循环思维方式预览, 并在10月的K展会2022上介绍了主题和活动。该预览涵盖了新技术和创新技术, 包括循环聚烯烃产品组合Borneables™的新包装和基础设施应用, 采用可再生原料制造。此外, 还展示了可回收性、再利用、化学回收和先进机械回收设计的新应用。

“向再生和循环系统的转型是定义社会挑战的时代,”北欧化学聚烯烃、创新和技术执行副总裁Lucrèce Foufopoulos

los表示，“我们展望未来，塑料科循环，碳中和了，这只能通过在整个价值链上采取果断和协调的行动来实现。我们现在必须采取行动，创造更美好的明天。我们欢迎K展会2022的召开，以表明我们对“创新合作加速”的承诺，并推动我们行业的转型。”

### *A First Glimpse of the Topics, Activities and Highlights Provided at K 2022*

■ K 2022 in Düsseldorf is approaching fast, and preparations are in full swing. 13 June, EREMA Group and Borealis invited representatives of the international plastics and recycling trade press to Upper Austria for a sneak preview of the technological developments and lighthouse projects that the companies will present at K 2022. The venue for the pre-K event was EREMA Group headquarters in Ansfelden, Austria.

"Our mission 'Another life for plastic, because we care', is also our tagline at this year's trade fair. This underlines what EREMA company group will be showing plastics industry insiders and all other visitors to the trade fair: That it is possible to implement a circular economy if everyone in the value chain works together," said Manfred Hackl, CEO EREMA Group GmbH, in his opening presentation.

In Düsseldorf, the subsidiaries of the **EREMA Group** – which are EREMA, PURE LOOP, UMAC, 3S, KEYCYCLE and PLASMACH – will present their technological innovations, services and support together at a Group trade fair stand for the first time. Seven new recycling systems and components will be presented that enable large-scale plants with a production capacity of up to 6 t/h while setting a milestone in recyclate quality and process stability. This is made possible by technological innovations in the plasticizing unit that have been specially developed for high throughputs with low specific energy consumption, the new EREMA 406 laser filter with a 50 percent larger screening area, and new digital assistance systems that will be launched at K 2022 and made available on the Blu-Port® customer platform. These include, for example, the PredictOn app, which helps to anticipate and eliminate im-

minent malfunctions based on continuous measurement and evaluation of machine data.

"CHEMAREMA is a new series we have developed for mechanical material processing as part of the chemical recycling process," says Hackl by way of introducing another EREMA innovation. Mechanical processes are often at the beginning of the process chain for chemical recycling to prepare input streams and ensure a reliable, continuous and energy-efficient flow of feed material. CHEMAREMA features extrusion technology that can be adapted to the application requirements and is designed precisely for downstream chemical processes.

For customers looking for rapidly available recycling systems for simple applications, EREMA Group subsidiary UMAC has an innovation in store for K 2022. The company, which has so far specialised in refurbishing and trading in previously owned equipment, is expanding its business area and in Düsseldorf will launch READYMAC, a standardised, prefabricated recycling solution that can be produced from stock, based on proven EREMA TVE technology.

Finally, in the inhouse recycling segment, PURE LOOP and PLASMACH will round off the wide range of machines offered by the group of companies with their product portfolio.

In the outdoor area of the K show, EREMA will bring plastics recycling to life with live demonstrations in conjunction with cooperation partners. Different waste streams are processed for this purpose. The wide variety of high-quality applications for recyclate will be showcased in the "products made of recyclate" exhibition, ranging from technical components to consumer goods and food packaging.

At the EREMA Group, anticipation is already at a high level in the run up to K 2022. "The circular economy has become a mega-topic in the plastics industry, even for plastic waste, although this was unthinkable just a few years ago. This boost confirms the work we have done over the past few years. There is still a lot to do, but all the players in the value chain are now pulling in the same direction. That is something that will be seen and felt at this year's K show," says Manfred Hackl.

**Borealis** – accelerating the transition towards a more circular future: Borealis is dedicated to sustainable business growth through innovation that drives the circular transformation of our industry. The K Fair 2022 theme 'Innovate Collaborate Accelerate' highlights the need to work ever more closely with partners around the globe to produce differentiated polyolefins-based solutions that make circular, modern life possible for society as a whole. Achieving the huge transformation from today's linear system to the circular one of tomorrow will require innovation, collaboration, and acceleration throughout the entire value chain.

Borealis is committed to using their expertise and global reach to advance the circular economy of plastics. At the joint Pre-K 2022 kick-off on June 13, Borealis provided a preview of their integrated way of circular thinking and featured topics and activities at the K Fair 2022 in October. The preview covered new technologies and innovations including new packaging and infrastructure applications of the Borealis™ portfolio of circular polyolefin products, manufactured with renewable feedstocks. New applications for Design for Recyclability, Re-Use, chemical recycling and advanced mechanical recycling were also on display.

"The transformation to a regenerative and circular system is an era-defining societal challenge," states Lucrèce Foufopoulos, Executive Vice President Polyolefins, Innovation and Technology, Borealis. "We envision a future of plastics circularity and carbon neutrality, which can only be achieved by decisive and coordinated action across the value chain. We must act now for a better tomorrow. We welcome the occasion of the K Fair 2022 to demonstrate our commitment to 'Innovate Collaborate Accelerate' and drive the transformation of our industry."

#### ► **EREMA Group**

[www.erima.com](http://www.erima.com)

**K 2022: Hall 09, Stand 9C09 and outdoor area, Stand FG-CE03**

**K展会2022：9号展厅，9C09展位，和户外区域，FG-CE03展位**

#### ► **Borealis**

[www.borealisgroup.com](http://www.borealisgroup.com),

[www.borealiserverminds.com](http://www.borealiserverminds.com)

**K 2022: Hall 6, Stand A43**

**K展会2022：6号展厅，A43展位**



## 密集冷却“短排气道”技术

加工 90% 1MI LLDPE 富混合物的短排气道试验表明，与 Addex 的原始 Intensive Cooling™ “Down-on-the-Die”版本相比，产量增加了 28%，与传统的双流道风环相比，该版本已经将产量提高了 10% 至 15%

*Short Stack trials running 90% 1MI LLDPE rich blend demonstrate a 28% increase in output over Addex's original Intensive Cooling™ “Down-on-the-Die” version, which already improves output by 10 to 15% over conventional dual-flow air rings*

■ 高性能吹膜冷却设备的领先供应商 Addex 将在即将于德国杜塞尔多夫举行的 K 2022 展览会上推出其专利密集冷却技术的最新版本“短排气道”。

短排气道是 Addex 强化冷却系统的重大升级，该系统于 2016 年首次推出。它通常比公司最初的强化冷却“模具”版本增加 25% 的产量，该版本已经比传统的双流空气环提高了 10% 到 15% 的产量。

Addex Inc. 总裁 Bob Cree 表示：“我们将密集冷却技术提升到了一个新的水平，为处理器提供了更高的产量和生产率。”“在越来越苛刻的客户处理要求的推动下，密集冷却产品将继续发展。”

强化冷却是 Addex 冷却气泡的独特方法，它改变了当今吹膜空气环的常见空气动力学，从而显着提高稳定性和产量。Addex 成功地将额外的高速气流添加到所有空气环常见的传统单一高速“主唇”气流中。每个新的高速气流自然提供一个牢固的稳定“锁定”点，不仅提供强烈的冷却，还将气泡牢牢地固定在适当的位置，提供一些处理器所说的“难以置信的气泡稳定性”。另一个独特的设计元素是将空气环密封到模具的顶面。正稳定和高强度冷却可以在工艺的早期开始，就在模唇上方，这使得难以运行的薄膜能够以更高的输出速度运行。

在新的短排气道配置中，膜泡通过位于模具和空气环之间的圆形外壳被拉动，该外壳自然地将气泡拉入超大的空气环中，从而进一步增加产量。与其他难以测试的凸起系统不同。

### Intensive Cooling “Short Stack” Technology

■ Addex, a leading supplier of high-performance blown film cooling equipment, will launch the latest iteration of its patented Intensive Cooling™ technology, the “Short Stack,” at the upcoming K 2022 exhibition in Düsseldorf, Germany. Short Stack is a major upgrade to Addex's Intensive Cooling system which was first

introduced at K 2016. It typically delivers a 25% increase in output over the company's original Intensive Cooling “Down-on-the-Die” version, which already improves output by 10 to 15% over conventional dual-flow air rings.

“We've taken our Intensive Cooling technology to the next level, affording processors even greater output and productivity,” said Bob Cree, President of Addex Inc. “Intensive Cooling products will continue to evolve, fueled by ever more demanding customer processing requirements.”

Intensive Cooling is Addex's unique approach to cooling the bubble which changes the common aerodynamics of present-day blown film air rings to dramatically increase stability and output. Addex has successfully added additional high-velocity air streams to the traditional single, high-velocity “main lip” air stream common to all air rings. Each new high-velocity air stream naturally provides a firm stabilization “lock point” that not only provides intense cooling, but also firmly holds the bubble in place, providing what some processors call “incredible bubble stability.” Another unique design element is sealing the air ring to the top surface of the die. Positive stabilization and high-intensity cooling can begin earlier in the process, literally just above the die lip, which makes hard-to-run films capable of running at higher output speeds.

In the new Short Stack configuration, the bubble is pulled through a circular enclosure located between the die and air ring that naturally pulls the bubble into an oversized air ring which further increases output. Unlike other raised-up systems that are difficult to start up because the bubble must be pulled out and around



equally oversized internal bubble cooling (IBC) hardware (which is required to push the bubble outward into the air ring), the Short Stack does this naturally, so it can be run with or without conventional IBC hardware.

The Short Stack incorporates an additional Intensive Cooling element that adds two more high-velocity air flows to the original Down-on-the-Die version released in 2017 (which had one additional lock point), for a total of three locking points, guaranteeing substantially higher output rates due to the increased stability, which in turn allows for processing much lower melt strength materials than possible before. Another major advantage is that few, if any adjustments are needed, even with material changes, making it easy to run.

The Addex Short Stack is proving to be successful over a wide range of processes including larger blow-up ratios/thin materials; smaller blow-up ratios/thick materials; along with high-melt strength as well as very low-melt strength processes. The company guarantees an output increase of 20 to 30% for retrofits. Since Short Stack is not height-adjustable and adds three more points of stabilization, it doesn't require a highly trained operator to run it, unlike other height-adjustable raised-up systems.

► Addex Inc.  
www.addexinc.com  
K 2022: Hall 17, Stand C41  
K 展会 2022 : 17号展厅 , C41展位

## 高超的 PET 瓶到瓶回收艺术参展 K 2022

■ 在 K 2022 展会上，Starlinger 回收技术将以 recoSTAR PET art 展示公司在 PET 回收领域的最新型设备。除了 Starlinger 的知名技术解决方案，如在食品应用中的卓越净化性能和出色的 rPET 颗粒质量，新型设备的特点是极低的能耗和大幅度简化的维护。

35 年来，Starlinger 回收技术致力于塑料废料的处理，使其可以用作新料的替代资源。Starlinger 回收设备在世界各地应用于各种行业的废旧塑料再处理，以缓解垃圾问题和资源紧缺。理想的情况是形成封闭的包装循环--就像 PET 饮料瓶那样。

“PET 瓶到瓶回收流程使一个用过的矿泉水瓶再次成为一个新的矿泉水瓶，这可以称之为高超的艺术”，Starlinger 回收技术公司的商务经理 Paul Niedl 这样说道。“这是一种组合，是经验与最新科学知识和顶级技术标准相结合的整体艺术。我们新的 recoSTAR PET art 融合了在食品接触 PET 回收领域 20 年的经验。这还包括技术改进，使设备更容易维护且能效更高--这在如今的时代，特别是在欧洲，是一个重要的主题。但我们不想提前透露太多--在 K 2022 展会和我们在什未林的动态日上，感兴趣的各方可以详细了解 recoSTAR PET art 及其全部技术创新。”

新的 recoSTAR PET art 预干燥单元和挤出机将在 9 号厅的 Starlinger 回收技术展台展出，SSP 反应器将在 16

号厅的 Starlinger 展台展出。公司还将展示在聚酯纤维/长丝回收和消费后聚烯烃回收领域的机械解决方案，包括异味减少技术。

2022 年 10 月 26 日至 27 日，Starlinger 回收技术将在德国的什未林工厂与 K 展会同步举办“动态日”厂内展览，届时将展示新型的 recoSTAR PET art 和 recoSTAR 动态回收设备的运行。有兴趣的客户将有机会通过包机和巴士接送的方式，在选定的日期从杜塞尔多夫经罗斯托克往返什未林。

### *The Fine Art of PET Bottle-to-Bottle Recycling*

■ At K 2022, Starlinger recycling technology will showcase the recoSTAR PET art, the company's latest plant model in the field of PET recycling. In addition to Starlinger's established technology solutions such as excellent decontamination performance for food contact applications and impeccable rPET pellet quality, the new plant is characterized by particularly low energy consumption and considerably simplified maintenance processes. For 35 years now, Starlinger recycling technology has been involved in processing plastic waste so that it can be used as an alternative resource to virgin materials.

通过 Starlinger recoSTAR PET art 回收设备，Starlinger 开启 PET 瓶对瓶回收的新篇章。这将在 K 2022 展会和在什未林的 Starlinger 动态日上首次向公众展示(©Starlinger)

*With the recoSTAR PET art recycling line, Starlinger is starting a new chapter in PET bottle-to-bottle recycling. It will be presented to the public for the first time at K 2022 and the Starlinger Dynamic Days in Schwerin (©Starlinger)*



Starlinger recycling plants are used the world over to recycle used plastics from a wide variety of sectors, thus counteracting the problem of waste and scarcity of resources. Ideally, closed packaging cycles are created – as is the case with PET beverage bottles.

“What happens in the PET bottle-to-bottle recycling process to turn a used mineral water bottle back into a new mineral water bottle can be called high art,” says Paul Niedl, Commercial Director at Starlinger recycling technology. “It is a composition, a synthesis of experience combined with the latest scientific knowledge and high technological standards. Our new recoSTAR PET art embodies 20 years of experience in the field of PET food contact recycling. In addition, technical improvements have been made to make the plant easier to maintain and even more energy-efficient – in times like these, this is an important issue, especially in Europe. But we don’t want to give too much away in advance – at K 2022 and our Dynamic Days in Schwerin, interested parties can learn about the recoSTAR PET art and all its technological innovations in great detail.”

The pre-drying unit and the extruder of the new recoSTAR PET art will be on display at the Starlinger recycling technology stand in Hall 9, and the SSP reactor at the Starlinger stand in Hall 16. The company will also be showcasing machine solutions from the fields of polyester fibre/filament recycling and recycling of post-consumer polyolefins, including odour reduction technology.

On 26 and 27 October 2022, while the K trade fair is taking place, Starlinger recycling technology will also be holding its “Dynamic Days” in-house exhibition at its Schwerin site in Germany, where the new recoSTAR PET art and a recoSTAR dynamic recycling plant will be in operation. Interested customers will have the option of travelling from Düsseldorf to Schwerin via Rostock and back again on their chosen day by means of a charter flight and bus transfers.

► **Starlinger recycling technology**  
[www.recycling.starlinger.com](http://www.recycling.starlinger.com)  
**K 2022: Hall 9, Stand D07**  
**K展会2022 : 9D07号展位**



## “质量第一”

■ 朗盛 (LANXESS) 将在杜塞尔多夫的K展2022上以“质量第一”为座右铭参展。这家特种化学品公司将在其700平方米的展位上展示塑料行业的材料开发以及新工艺和新技术。此外，还将展出橡胶和聚氨酯行业的可持续产品和系统解决方案，以及聚合物行业的着色剂和中间体。

朗盛今年展会的重点主题是电动汽车和可持续性。“我们希望在经济和全球价值链转型中发挥积极作用，以实现更可持续的世界。”朗盛管理委员会成员Hubert Fink博士说，“利用我们的材料，我们支持我们的客户制造更为可持续的产品，这些产品具有更低的碳足迹，并保护资源和气候。”

高性能材料业务部门专注于可持续材料和轻量化解决方案。主要领域是材料和部件概念，以在未来电动汽车市场中实现一致的轻质结构。

此外，业务部门将展示基于回收物或生物原料的新型Tepex复合材料。这里的一个例子是刚刚上市的Tepex dynalite Scopeblue 813，它是由亚麻纤维和聚乳酸制成。同时展出的还具有聚酰胺6基体的Tepex dynalite，其聚酰胺6基体由“绿色”环己烷制成，因此包含80%以上的可持续原材料。

朗盛的聚合物添加剂和无机颜料业务部门为塑料行业提供高性能、可持续的直接着色剂。各业务部门将展示其彩色塑料制品的节能生产产品系列，从而无需后续涂层，避免返工。这包括通用产品和有特殊要求的专用产品。

对于溴化和磷基解决方案，朗盛的聚合物添加剂业务部门提供了世界上最全面的有机阻燃剂系列。聚合物和反应性阻燃剂减少了聚合物中添加剂的释放，从而有助于环境和健康保护，而不损害消防安全。由于其高效性，溴化阻燃剂广泛应用于建筑和电子行业。除了有效的防火之外，磷基阻燃剂还具有其他优点，如在PU和PVC系统中具有良好的加工性能和高弹性。

莱茵化学 (Rhein Chemie) 业务部门将介绍橡胶加工行业的各种添加剂。这些包括预分散化学品、加工促进剂、硫化和填料活化剂。本着促进可持续发展的精神，我们的重点不仅是橡胶生产，还包括为轮胎、软管、密封件、型材和传动带等一系列应用设计的高质量、耐用橡胶产品的制造。

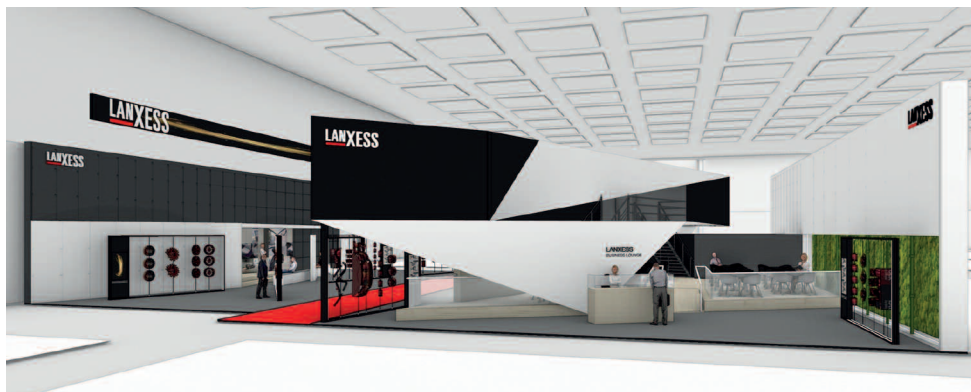

### „Quality Works“

■ LANXESS will be exhibiting at K 2022 in Duesseldorf under the motto “Quality Works”. The specialty chemicals company will present material developments as well as new processes and technologies for the plastics industry at its 700-square-meter booth. In addition, sustainable products and system solutions for the rubber and polyurethane industries will be on display, as well as colorants and intermediates for the polymer sector.

LANXESS' focus topics for this year's trade fair are electromobility and sustainability. “We want to play an active role in the transformation of the economy and global value chains towards a more sustainable world,” says Dr. Hubert Fink, member of the LANXESS Board of Management. “With our materials, we support our customers in manufacturing more sustainable products that have a lower carbon footprint and conserve resources and the climate.”

The High Performance Materials business unit focuses on sustainable material and lightweight solutions. Main areas are materials and component concepts for consistent lightweight construction in the future market of electromobility.

Furthermore, the business unit will present new Tepex composites based on recyclates or bio-based raw materials. One example here is Tepex dynalite Scopeblue 813, which has just been launched on the market and is produced from flax fibers and polylactic acid. Also on show will be a Tepex dynalite with a polyamide 6 matrix that is produced starting from “green” cyclohexane and therefore consists of well over 80 percent sustainable raw materials.

LANXESS' Polymer Additives and Inorganic Pigments business units offer the

plastics industry high-performance, sustainable colorants for direct coloration. The business units will present their product ranges for the energy-efficient production of colored plastic goods, which eliminate the need for subsequent coating and thus avoid reworking. This includes both universal products and specialties for particular requirements.

With brominated and phosphorus-based solutions, LANXESS' Polymer Additives business unit offers one of the most comprehensive ranges of organic flame retardants in the world. The polymeric and reactive flame retardants reduce the release of additives from polymers, thus contributing to environmental and health protection without compromising fire safety. Due to their high efficiency, brominated flame retardants are widely used in the construction and electronics industries. In addition to effective fire protection, phosphorus-based flame retardants offer other advantages such as good processability and high elasticity in PU and PVC systems.

A wide range of additives for the rubber processing industry will be presented by the Rhein Chemie business unit. These include predispersed chemicals, processing promoters and vulcanization and filler activators. In the spirit of advancing sustainability, the focus will be on not only rubber production but also the manufacture of high-quality, long-lasting rubber products designed for a whole range of applications such as tires, hoses, seals, profiles, and drive belts.

#### ► LANXESS AG

lanxess.com

K 2022: Hall 06, Stand C76-C78

K展会2022：5号展厅，C76+C78展位

## 用塑料加速迈向可持续未来的旅程

■ 巴斯夫 (BASF) 将在K展会2022上展示其向循环经济目标迈进的历程。自1952年首次举办交易会以来,巴斯夫一直在K展会上参展,不断展现其对塑料行业的承诺以及与客户一起创造突破的能力。

“在K展会2022上,我们的主题是‘出发!创造——欢迎来到我们的塑料之旅’,”性能材料总裁Martin Jung博士说,“我们邀请所有参观者加入我们可持续塑料未来之旅。我们将展示产品和解决方案,除此之外,我们还希望对我们的概念和计划提出见解。实现更可持续经济的塑料之旅需要一种合作方式,这还有很长的路要走。这就是我们想要表达的。”塑料之旅包括三个阶段,代表塑料的生命周期:制造、使用和回收。巴斯夫为这三个阶段提供市场领先的产品和解决方案。

“我们将在K展会2022上展示我们的能力和想法,展示与来自汽车、建筑、电子电器、包装和消费者等行业合作伙伴和客户的众多共同创造项目,”Jung补充道,“这些项目包括净零或低生产碳足迹的产品,以及由回收原材料制成的新产品,以保护化石原材料。作为一家拥有自己基础化工生产的综合公司,我们是帮助客户实现价值链脱碳的关键推动力。“巴斯夫已承诺到2030年将二氧化碳排放量减少25%,到2050年实现二氧化碳净零排放。”

另一个重点将是数字和数据驱动的价值链模型,帮助巴斯夫的客户向二氧化碳碳中和的未来转型。在这一领域,巴斯夫引入了行业领先的数字应用程序,用于计算大约45000种巴斯夫所销售产品的二氧化碳排放量。

### 制造:巴斯夫解决方案改善塑料制造方式

“制造阶段涉及改进塑料的制造方式——从产品设计到原材料的选择和制造过程本身,”Jung解释道。在K 2022年,巴斯夫将展示跟踪和减少不同行业整个价值链的产品碳足迹的解决方案。例如,巴斯夫是Catena-X的成员,这是汽车行业建立数据驱动生态系统的合作努力。

巴斯夫还将展示一系列使用可再生或再循环原料减少产品碳足迹的解决方案,如Styrenics在包装和建筑领域的产品组合。

### 用途:巴斯夫解决方案改善塑料性能

“塑料具有许多可持续性优

势,”Jung强调,“在其生命周期的使用阶段,塑料发挥了其所有优势:通过其重量轻提高能源效率,通过其坚固性和峰值性能延长产品生命周期,以及在电动汽车和家用电器等领域实现更可持续的应用。”在K展会2022上,巴斯夫将展示塑料作为可持续发展的真正高性能材料的几个例子:从用于电子移动充电基础设施内高压组件的安全耐用聚酰胺,到为电子电气业务提供绿色微型断路器(MCB),该断路器使用了100%回收的报废轮胎的热解油的PA6基化合物。

### 回收:巴斯夫解决方案改进塑料的回收方法

“关于塑料的关键问题是它们在生命的尽头会发生什么,”Martin Jung博士强调,“为了实现循环经济,我们需要更好地回收塑料,以结束循环。”

为了推进塑料旅程的回收阶段,巴斯夫提供了多种产品包,以追求和扩展所有现有的回收方法。巴斯夫的子公司创迈思(trinamiX)公司提供了创新的移动近红外(NIR)光谱解决方案,用于分类、识别不同类型的塑料废物,而巴斯夫的IrgaCycle™是一系列新的添加剂解决方案,可改善塑料的机械回收。对于化学回收,巴斯夫提供了通过ChemCycling™获得的含有原材料的多种产品。为了完成回收措施,巴斯夫展台还配备了经认证的可堆肥生物聚合物ecovio®:它支持食物垃圾和食物污染包装的有机回收,从而更多避免了食物垃圾从填埋和焚烧的转移。

### Accelerating the Journey Towards a Sustainable Future with Plastics

■ BASF will present its journey to advance towards the goal of a circular economy at K 2022 trade fair. BASF has been exhibiting at K ever since the trade fair debuted back in 1952, continuously showing its commitment to the plastics industry and ability to create breakthroughs together with its customers “At K 2022, our theme is ‘Go! Create – Welcome to Our Plastics Journey’,” says Dr. Martin Jung, President Performance Materials, “We invite all visitors to join our journey towards a sustainable future with plastics. We will show products and solutions and more than that we want to

give insights in our concepts and plans. The Plastics Journey towards a more sustainable economy needs a co-operative approach and this has a long way to go. That’s what we want to express.” The Plastics Journey consists of three phases which represent the lifecycle of plastics: MAKE, USE, and RECYCLE. BASF offers market-leading products and solutions for all three phases of this journey.

“We will demonstrate our capabilities and thoughts at K 2022 exhibiting numerous co-creation projects with partners and customers from industries like Automotive, Construction, E&E, Packaging, and Consumer,” Jung adds, “These projects range from products that have net-zero or low Product Carbon Footprints to new products made from recycled raw materials to conserve fossil raw materials. As an integrated company with our own base chemical production, we are a key enabler in helping our customers decarbonize their value chains.” BASF has committed to reducing CO<sub>2</sub> emissions by 25% by 2030 and reaching net zero CO<sub>2</sub> emissions by 2050.

Another strong focus will be on digital and data-driven value chain models that help BASF’s customers transform towards a CO<sub>2</sub> neutral future. In this area, BASF has introduced an industry-leading digital application to calculate the CO<sub>2</sub> emissions of around 45,000 BASF sales products.

### MAKE: BASF solutions improve how plastics are made

“The MAKE phase is about improving how plastics are made – from product design to the choice of raw materials and the manufacturing process itself,” explains Jung. At K 2022, BASF will present solutions to track and reduce the Product Carbon Footprint along the entire value chain of different industries. For example, BASF is a member of Catena-X, a collaborative effort of the automotive industry to build a data driven ecosystem. BASF will also showcase a number of solutions to reduce the Product Carbon Footprint using renewable or recycled feedstock like in the case of the Styrenics portfolio in packaging and construction.



### USE: BASF solutions improve the performance of plastics

"Plastics come with many sustainability benefits," emphasizes Jung, "In the USE phase of their lifecycle, plastics play out all their strengths: by improving energy efficiency through their light weight, by prolonging product lifecycles thanks to their robustness and peak performance, and by enabling more sustainable applications in sectors such as e-mobility and household appliances."

At K 2022, BASF will show several examples of plastics being true performance materials for sustainability: from safe and durable polyamides for high-voltage components within the e-mobility charging infrastructure to enabling a green miniature circuit breaker (MCB) for the E&E

business that uses a 100% recycled PA6 based compound using pyrolysis oil from end-of-life tires.

### RECYCLE: BASF solutions improve the recycling methods of plastics

"The crucial question about plastics is what happens to them at the end of their life," emphasizes Dr. Martin Jung, "To achieve a circular economy, we need to get much better at the recycling of plastics to close the loop."

To advance the RECYCLE phase of the Plastics Journey, BASF offers several product packages that pursue and expand all existing recycling methods. While the BASF subsidiary trinamiX offers innovative mobile near-infrared (NIR) spectroscopy solutions for sorting and identifying dif-

ferent types of plastic waste, BASF's IrgaCycle™ is a new range of additive solutions that improves the mechanical recycling of plastics. For chemical recycling, BASF offers a variety of products containing raw materials obtained via ChemCycling™. To complete the recycling methods, the BASF booth also features the certified compostable biopolymer ecovio®: It supports organic recycling of food waste and food-soiled packaging thus increasing the diversion of food waste from landfill and incineration.

#### ► BASF

[www.basf.com](http://www.basf.com)

[www.plastics.basf.com/K2022](http://www.plastics.basf.com/K2022)

K 2022: Hall 05, Stand C21+D21

K展会2022: 5号展厅, C21+D21展位

## 以新的可持续解决方案应对交通挑战

■ DOMO 将展示其聚酰胺解决方案以及专业技术和服务, 展示如何帮助客户满足未来的应用需求。作为您首选的工程材料合作伙伴, DOMO 将引领参展者开启 Xperience 旅程, 体验基于领先 TECHNLYL® 品牌的解决方案, 并了解 DOMO 的全新品牌架构。

此外, 可持续性专区将重点展示 DOMO 宏伟的 2030 年可持续性目标, 并聚焦于脱碳、可再生能源使用以及客户解决方案。

二氧化碳减排依旧是行业面临的主要挑战, DOMO 的低碳足迹解决方案将帮助客户实现减碳目标。近期, 金属轻量化替代方案、热管理以及电动出行领域取得了不错的进展, 刺激了全球对可持续高性能聚酰胺解决方案的需求。在 2022 年 K 展上, DOMO 将通过举办专题技术研讨会及小组讨论, 展示为汽车产业打造的 TECHNLYL® 4EARTH® 品牌的全新可持续解决方案。

作为一家领先的、全面整合聚酰胺 6 和聚酰胺 66 的解决方案供应商, DOMO 还将展示其化学中间体、基础聚合物和高性能纤维。在展区, 参展者可以了解到更多关于最新 NYLEO® 高性能纤维的创新技术, 包括更好的阻燃性、增强的生物降解性以及抑菌特性等。DOMO 的领导品牌 DOMAMID® 和

STABAMID® 为工程塑料、薄膜、纤维和纺织行业提供始终如一的高质量解决方案, 助力提高最终产品的性能。

2022 年 K 展聚焦于气候以及循环性, DOMO 也强调更高的可持续性目标。包括扩大循环性产品在工程材料销售中的占比, 目标从当前的 10% 提升至 2030 年的 20%, 并在 2035 年提升至 30%。研发新的循环性牌号以及增加原料与二氧化碳减排计划息息相关。DOMO 还将简要展示溶解技术、化学回收以及生产废料回收。

国际市场首席商务官 Ludovic Tonnerre 说道: "我们是 TECHNLYL® PA6 和 PA66 产品的卓越供应商, "在 2022 年 K 展上, 我们将展示为什么聚酰胺仍然是众多应用中最负盛名的材料, 对于汽车行业尤其如此。客户将体验我们的 MMI 预测模拟工具如何通过数字技术支持可持续性程度更高、更轻便的解决方案实现, 尤其是在汽车行业。"他补充道。

除了创新性、可持续聚合物和树脂产品系列外, 客户还可以体验 DOMO 的 SERVICE HUB (服务中心)。这个独一无二的平台支持制造商快速革新, 让他们在瞬息万变的市场上保持领先。

我们的互联模拟、3D 原型设计以及零部件测试服务整套方案帮助客户将

零部件性能提升到新高度, 并在汽车、消费类电子产品以及供暖和制冷等行业中加快产品上市步伐。

参展者也能够看到 TECHNLYL® C 系列 PA6-GF 材料扩展数据库以及我们最新的注塑成型模拟数据库。DOMO 的专家们将在现场一起讨论成功案例、应用模拟以及原型。参展者还可以进行一场虚拟实验室之旅, 探索 DOMO 应用零部件测试实验室的能耐。

欧盟和欧洲出口首席商务官 Philippe Guérineau 说: "我们整合聚酰胺 6 和聚酰胺 66, 我们拥有化学中间体和工程材料专业知识, 我们能够作出交付承诺, 如此种种转化成了更好的解决方案和更好的定制产品。"我们的参展应用专家将提供可靠、高质量的技术专业知识、实践指导和研发支持。"

DOMO 致力于实现循环经济, 很早便开始支持初创公司 Circularise, 该公司运用区块链技术在整个价值链中实现塑料更好的溯源性。DOMO 认为追溯所有原材料来源的能力对于保证材料循环利用至关重要。在 DOMO 展馆, 参展者将能在超过 100 平方米的展区中体验 Circularise 公司的创新, 并能与区块链专家见面。

Circularise 联合创始人 Jordi de Vos 说: "我们认为数据在整条价值链中



更透明对真正实现循环经济必不可少。”“我们的区块链技术能打造可溯源、透明且可循环的供应链，这比以往任何时候都更重要。DOMO 帮助我们研发了第一代平台，该平台专为塑料行业定制。我们期待我们的联合展区以及小组展示，”他补充道。

### Meeting Mobility Challenges With New Sustainable Solutions

■ DOMO will be showcasing how its polyamide-based solutions, along with its expertise and services, will help customers meet their future application requirements. As the partner of choice for engineered materials, DOMO will guide visitors through an Xperience path with solutions based on the leading TECHNYL® brand and DOMO's new brand architecture.

In addition, a dedicated sustainability corner will highlight DOMO's ambitious 2030 sustainability targets, with a focus on decarbonization, renewable energy consumption and customer solutions.

CO<sub>2</sub> reduction continues to be a major challenge for the industry and DOMO's low carbon footprint solutions help enable its customers' carbon reduction ambitions. Recent developments in lightweight metal replacement, thermal management and e-mobility reinforce the global need for sustainable polyamide-based performance solutions. At K 2022, DOMO will present new sustainable solutions based on the TECHNYL® 4EARTH® brand for the automotive sector through dedicated tech seminars and panel discussions.

As a leading and fully integrated polyamide 6 and polyamide 66 solutions provider, DOMO will also showcase its offering of chemical intermediates, base polymers and Performance Fibers. At the booth, visitors can learn more about the latest NYLEO® performance fiber innovations with improved flame retardancy, enhanced biodegradability and bacteriostatic properties. DOMO's leading brands DOMAMID® and STABAMID® provide the



DOMO 将参展，其大型户外展区占地约 400 m<sup>2</sup>

*DOMO Chemicals will be exhibiting with an expanded outdoor pavilion covering almost 400 m<sup>2</sup>*

engineering plastics, film, fiber and textile industries with consistently high-quality solutions for better end-product performance.

As a response to K 2022's focus on climate and circularity, DOMO is highlighting its stronger sustainability targets as the company prioritizes these initiatives into their business model. These include expanding the share of circular products in engineered material sales from 10% today to 20% by 2030 and 30% by 2035. Developing new circular grades and increasing feedstock are closely connected to its CO<sub>2</sub> reduction plans. DOMO will also present an overview of dissolving technologies, chemical recycling, and recycling from production waste.

"We are the home of excellence for PA6 and PA66 with TECHNYL®," said Ludovic Tonnerre, Chief Commercial Officer International Markets. "At K 2022, we will showcase why polyamides remain the best-known material for a wealth of applications, in particular within the automotive sector. Customers will also experience how our MMI Predictive Simulation digitally supports the implementation of more sustainable and lighter solutions," he added.

"Our integration in polyamide 6 and polyamide 66, our expertise from chemical intermediates to engineered materials, and our delivery promise translate into better solutions and better customized-products," said Philippe Guérineau, Chief

Commercial Officer EU & Europe Export. "Our application experts at the booth will offer reliable and high-quality technical expertise, practical guidance and R&D support."

Working towards a circular economy, DOMO was an early supporter of Circularise, a start-up that uses blockchain technology for better traceability of plastics across the value chain. DOMO believes that being able to trace the origin of all raw materials is essential to ensuring that materials can be reused or recycled. At the DOMO pavilion, visitors will experience over 100 m<sup>2</sup> of Circularise-based innovations and meet with blockchain experts.

"We believe that better data transparency across the entire value chain is necessary to truly realize a circular economy," said Jordi de Vos, Circularise co-founder. "Our blockchain technology enables traceable, transparent and circular supply chains, which has become more important than ever. DOMO has helped us develop our first iteration of the platform tailored for the plastics industry. We look forward to our joint booth and panel presentations at the pavilion," he added.

➔ **DOMO Chemicals**  
[www.domochemicals.com](http://www.domochemicals.com)  
[k2022.domochemicals.com](http://k2022.domochemicals.com)  
**K 2022: FG.4 04.3**  
**K展会2022 : FG.4 04.3展位**

<b>A</b> ddex .....	60
<b>B</b> ASF .....	08, 13, 63
battenfeld-cincinnati .....	24, 44
Bekum .....	09
Borealis .....	56
Brückner Maschinenbau .....	47
Brückner Servtec .....	48
BUSS .....	14
<b>D</b> OMO .....	64
<b>E</b> con .....	32
Erema .....	58
Erge .....	11
<b>F</b> ujian Forop .....	09
<b>G</b> neuss .....	19
Guill .....	封面 / Front Cover, 16, 18, 20
<b>I</b> MS .....	09
interpack 2023 .....	06
<b>K</b> 2022 .....	39
Kautex .....	27
Kiefel .....	50
KraussMaffei .....	54
Kündig .....	13, 36
<b>L</b> ab Conference .....	Inside Back Cover
Lanxess .....	62
<b>M</b> eaf .....	55
Messe Düsseldorf .....	06, 08, 39
<b>P</b> alsgaard .....	56
Promix .....	30
<b>R</b> eifenhäuser .....	26, 52
Repsol .....	14
<b>S</b> ikora .....	28, 41
Smart-Extrusion .....	Inside Front Cover, ..... Outside Back Cover
SML .....	29
Starlinger .....	14, 34, 61
<b>U</b> niteChem .....	10
<b>V</b> etaphone .....	12
VisiConsult X-ray .....	17
VM Verlag .....	04, 15
<b>Z</b> umbach .....	07

# 挤塑

**EXTRUSION  
ASIA EDITION**

**VM 出版社有限公司 / VM Verlag GmbH:**

Krummer Büchel 12, D-50676 Köln, Cologne, Germany

**VM 出版社有限公司 / 编辑+出版**

**VM Verlag GmbH – Editorial Office + Layout:**

P.O. BOX 50 18 12, D-50978 Cologne, Germany

*Bettina Jopp-Witt M.A.*

*(Editor-in-Chief EXTRUSION, EXTRUSION International,  
EXTRUSION Asia Edition)*

T.: +49 221 546 15 39, Fax: +49 221 168 60 13

email: b.jopp-witt@vm-verlag.com, redaktion@vm-verlag.com

*Dmitry Kosuch (Editor-in-Chief EXTRUSION Russian Edition)*

T.: +7 996 730 0113, email: d.kosuch@vm-verlag.com

**VM 出版社有限公司 / 广告与销售**

**VM Verlag GmbH – Sales + Distribution:**

P.O. BOX 50 18 12, D-50978 Cologne, Germany

*Dipl.-Ing. Alla Kravets (Administration)*

T.: +49 2233 9498793, Fax: +49 2233 9498792

e-mail: a.kravets@vm-verlag.com

*Martina Lerner (Sales)*

T.: +49 6226 97 15 15, e-mail: lerner-media@t-online.de

*Bella Eidlin (Sales)*

T.: +49 15229907895, e-mail: b.eidlin@vm-verlag.com

**第25出版年 – 出版次数：每年2期**

26. Volume – Frequency: 2 issues a year



**masterbatch**  
VERBAND

色母粒工會器官

**全球代理 / Representatives:**



JAPAN

Tel.: +81 (3) 32732731

extrusion@tokyopr.co.jp



CHINA & ASIA

Tel.: +86 13602785446

maggieliu@ringiertrade.com

Tel.: +886-913625628

sydneylai@ringiertrade.com

Tel.: +852-9648-2561

octavia@ringier.com.hk

**www.smart-extrusion.com**



## Web conference

December 8, 2022 • Start: 10.00 CET

[lab.extrusion-info.com](http://lab.extrusion-info.com)

The official language  
of the conference is English

# Laboratory & quality control in plastics processing

- laboratory equipment
- quality control of input raw materials
- quality control of finished products
- analytical equipment
- measuring equipment
- pilot and test lines
- desktop mini IMM and mini extruders
- laboratory mixers and compounders
- laboratory and processing simulation software
- metrology and equipment verification
- laboratory analysis services
- formulation development services
- certification services
- external engineering and research services
- R&D in the enterprise

Developed by:

**VM** VERLAG  
Cologne/Germany

**EXTRUSION**

**EXTRUSION**  
INTERNATIONAL  
WORLDWIDE

**ЭКСТРУЗИЯ**  
EXTRUSION RUSSIAN EDITION

**挤塑** EXTRUSION  
ASIA EDITION

**smart\_molding**  
international



Contact: Alla Kravets • Tel.: +49 2233 949 87 93 • [a.kravets@vm-verlag.com](mailto:a.kravets@vm-verlag.com)

# SMART EXTRUSION

**THE SPECIALIZED WEBPORTAL  
ON EXTRUSION  
FOR EVERY MODERN NEED**



**VM** Verlag GmbH  
Cologne, Germany



[www.smart-extrusion.com](http://www.smart-extrusion.com)